

User's Guide

Designer Quartz™ | 29

IMPORTANT SAFETY INSTRUCTIONS

When using an electrical appliance, basic safety precautions should always be followed, including the following:

Read all instructions before using this sewing machine.

Keep the instructions at a suitable place close to the machine. Make sure to hand them over if the machine is given to a third party.

DANGER – TO REDUCE THE RISK OF ELECTRIC SHOCK:

- A sewing machine should never be left unattended when plugged in. The electrical socket, to which the machine is plugged in should be easily accessible. Always unplug this sewing machine from the electric outlet immediately after using and before cleaning, removing covers, lubricating or when making any other user servicing adjustments mentioned in the instruction manual.

WARNING – TO REDUCE THE RISK OF BURNS, FIRE, ELECTRIC SHOCK, OR INJURY TO PERSON:

- This appliance is intended for use by adults. The appliance can be used with adult supervision by (i) children aged from 8 to 12 years and (ii) persons with reduced physical, sensory or mental capabilities or lack of experience and knowledge if they have been given instruction concerning use of the appliance in a safe way and understand the hazards involved. Cleaning and user maintenance shall not be made by children without supervision. It is not allowed for anyone to play with the machine. Children up to 8 years are not allowed to use the machine.
- Do not allow to be used as a toy. Close attention is necessary when this sewing machine is used by or near children.
- Use this sewing machine only for its intended use as described in this manual. Use only attachments recommended by the manufacturer as contained in this manual.
- Never operate this sewing machine if it has a damaged cord or plug, if it is not working properly, if it has been dropped or damaged, or dropped into water. Return the sewing machine to the nearest authorized dealer or service center for examination, repair, electrical or mechanical adjustment.
- Never operate the sewing machine with any air openings blocked. Keep ventilation openings of the sewing machine and foot control free from the accumulation of lint, dust, and loose cloth.
- Keep fingers away from all moving parts. Special care is required around the sewing machine needle.
- Always use the proper needle plate. The wrong plate can cause the needle to break.
- Do not use bent needles.
- Do not pull or push fabric while stitching. It may deflect the needle causing it to break.
- Wear safety glasses.
- Switch the sewing machine off (“0”) when making any adjustment in the needle area, such as threading needle, changing needle, threading bobbin, or changing presser foot, etc.
- Never drop or insert any object into any opening.

- Do not use outdoors.
- Do not operate where aerosol (spray) products are being used or where oxygen is being administered.
- To disconnect, turn all controls to the off (“0”) position, then remove plug from outlet.
- Do not unplug by pulling on cord. To unplug, grasp the plug, not the cord.
- The foot control is used to operate the machine. Never place other objects on the foot control.
- Do not use the machine if it is wet.
- If the LED lamp is damaged or broken, it must be replaced by the manufacturer or its service agent or a similarly qualified person, in order to avoid a hazard.
- If the cord connected with the foot control is damaged, it must be replaced by the manufacturer or its service agent or a similarly qualified person, in order to avoid a hazard.

SAVE THESE INSTRUCTIONS

Federal Communication Commission Interference Statement

For the USA and Canada

Responsible party: SINGER Sourcing Limited LLC
300 2nd Ave. S, Suite 300, Nashville, TN 37201, USA

Product name: HUSQVARNA® VIKING® VIKING® Designer
Quartz™ 29 Sewing Machine

This device complies with Part 15 of the FCC Rules and Innovation, Science and Economic Development Canada's licence-exempt RSS(s). Operation is subject to the following two conditions: (1) This device may not cause harmful interference, and (2) this device must accept any interference received, including interference that may cause undesired operation.

To satisfy radio frequency exposure requirements, a separation distance of 8" (20 cm) or more should be maintained between this device and persons during device operation. To ensure compliance, operations at closer than this distance is not recommended. The built-in antenna used for this transmitter must not be co-located in conjunction with any other antenna or transmitter.

This equipment has been tested and found to comply with the limits for a Class B digital device, pursuant to Part 15 of the FCC Rules and Canadian ICES-003. These limits are designed to provide reasonable protection against harmful interference in a residential installation. This equipment generates, uses and can radiate radio frequency energy and, if not installed and used in accordance with the instructions, may cause harmful interference to radio communications. However, there is no guarantee that interference will not occur in a particular installation. If this equipment does cause harmful interference to radio or television reception, which can be determined by turning the equipment off and on, the user is encouraged to try to correct the interference by one of the following measures:

- Reorient or relocate the receiving antenna.
- Increase the separation between the equipment and receiver.
- Connect the equipment into an outlet on a circuit different from that to which the receiver is connected.
- Consult the authorized HUSQVARNA® VIKING® VIKING® retailer or an experienced radio/TV technician for help.

The included interface cable should be used in order to ensure compliance with the limits for a Class B digital device.

 *Any changes or modifications not expressly approved by the party responsible for compliance could void the user's authority to operate this equipment.*

CE Declaration of Conformity

VSM Group AB Soldatorpsgatan 3, SE-554 74 Jonkoping, Sweden declare that the product:
Household Sewing Machine HUSQVARNA® VIKING® Designer Quartz™ 29 complies fully
with following EU directives:

- 2014/35/EU Low Voltage Directive
- 2014/30/EU EMC Directive
- 2011/65/EU RoHS Directive

and that the relevant harmonized standards are applied as listed:

- EN 60335-1:2012, A13:2017, A1:2019, A2:2019, A14:2019, A15:2021
- EN 60335-2-28:2003, A1:2008, A11:2018
- EN 62233:2008
- EN 50014-1:2021
- EN 55014-2:2021
- EN 61000-3-2:2019, A1:2021
- EN 61000-3-3:2019, A1:2019
- EN 63000
- EN 301 489-17 V3.2.0
- EN 301 489-1 V3.2.3
- EN 300 328 V2.2.2

Jonköping, June 2024

Carsten Raunsgaard

Manager Regulatory Compliance

TABLE OF CONTENTS

INTRODUCTION	1
Machine Overview	1
Needle Area	2
Right Side	2
Top of Machine	2
Overview Accessories	3
Included Accessories Not in Picture	3
Optional Accessories	3
Presser Feet	4
Function Buttons	6
Reverse Button	6
Start/Stop	6
Needle Up/Down	6
Speed Control Lever	6
Cut Function	6
Basic Gestures for the Touch Screen	6
Stitch Overview	7
Utility Stitches	7
Stitch Menu Overview	10
Sewing Guide Reference Chart	11
Recommended Settings - Overview	11
Fabrics Guide	11
PREPARATIONS	12
Unpacking Machine and Embroidery Unit	12
Connecting the Power Cord and Foot Control	12
Packing Away after Sewing	12
USB Port	13
Free Arm/Removable Accessory Tray	13
Presser Foot Lever	13
Thread Cutter	13
Thread Sensor	13
Spool Pins	14
Spool Caps	14
Threads	15
Stabilizers	16
Needles	17
Important Needle Information	17
Changing the needle	18
Selection Guide — Needle Size, Fabric, Thread	18
Bobbin Winding	19
Inserting the Bobbin	19
Threading the Upper Thread	20
Using the Needle Threader	21
Threading Tips and Hints	21
Threading for Twin Needle	22
Thread Tension	23
Sew without Feed Teeth	23
Changing the Presser Foot	24
Attaching the Embroidery Foot	24
Embroidery Preparations	25
Embroidery Unit Overview	25
Embroidery Hoop Overview	25
Embroidery Foot	25

Designs	26
Connecting the Embroidery Unit	26
Removing the Embroidery Unit	26
Hooing the Fabric	27
Attaching and Removing the Hoop	27
The Touch Screen	28
Common Functions	28
OK	28
Cancel	28
Settings	28
Settings	29
Machine Settings	29
Language	29
Save from USB	29
Save to USB	29
Settings	29
Firmware	29
Lock Screen	29
Hoop Options	29
Clear Download Cache	29
Embroidery and Sewing Settings	30
Activate Screensaver (min)	30
Auto Power Off	30
Audio	30
Detect Thread Break	30
Restore to Factory Default Settings	30
Machine Nickname	30
Automatic Thread Cutter	31
Needle Position	31
Firmware Update Using a USB Device	31
WiFi Introduction	32
Getting Started with WiFi	32
Other Network	32
Firmware Update Using WiFi	32
Complementary Software (PC and MAC)	33
mySewnet Cloud	33
App	33
mySewnet Website	33
mySewnet Library	33
Connect to mySewnet on Your Machine	34
Used Space in mySewnet Cloud	34
mySewnet Library on Your Machine	34
Sewing	35
Sewing Mode – Overview	35
What is a Stitch?	36
Select a Stitch or Letter	36
Create a Sequence	36
Fabric Guide	37
Woven or Knit	37
Stitch Settings	37
Stitch Width	38
Stitch Length	38

Needle Position / Stitch Positioning.....	38
Tie-Off.....	38
Mirroring.....	39
Balance Stitch.....	39
Free-Motion.....	39
Basic Sewing Techniques.....	40
Seam.....	40
Start to Sew – Straight Stitch.....	40
Change Needle Position.....	40
Change Sewing Direction.....	41
Finish Sewing.....	41
Seam and Overcast.....	41
Blind Hems.....	42
Darning and Mending.....	42
Repair Large Holes.....	42
Repair Tears.....	42
One-Step Buttonhole.....	43
Sew Zippers.....	44
Centered Zipper.....	44
Sewing Pop-up Messages.....	45
Embroidery.....	46
Getting Started to Embroider.....	46
Embroidery Mode– Overview.....	46
Load a Design.....	46
Create Embroidery Text.....	47
File Manager.....	47
Delete.....	47
Embroidery Edit – Overview.....	48
Total Number of Stitches in Design Combination.....	48
Control Wheel.....	48
Rotate.....	49
Thread Color Edit / Background Color.....	49
Thread color edit.....	49
Background color.....	49
Delete.....	49
Hoop Selection.....	50
Scale.....	50
Mirror Side to Side.....	50
Too Small Hoop.....	50
Embroidery Stitch Out.....	50
Multi-Select.....	51
Save Design.....	51
Embroidery Edit Pop-up Messages.....	52
Too many designs selected. Please remove a design and try again.....	52
The Bobbin Thread Is Running Low.....	52
Sound.....	52
Attention!.....	52
Save Design to the mySewnet Cloud.....	53
Send Design.....	53
mySewnet Library.....	54

Embroidery Stitch-Out.....	55
Embroidery Thread Tension.....	55
Embroidery Stitch-Out – Overview.....	55
Start/Pause.....	55
Thread Cut.....	55
Thread Color Blocks.....	56
Number of Stitches in Current Color Block.....	56
Return To Embroidery Edit.....	56
Step Stitch-by-Stitch/Go to Stitch.....	56
Exact Positioning.....	57
Corner Check.....	57
Embroidery Stitch Out Pop-up Messages.....	57
MAINTENANCE.....	58
Cleaning the Machine.....	58
Cleaning the Bobbin Area.....	58
Cleaning under the Bobbin Area.....	58
Troubleshooting.....	59
Service.....	64
Non-Original Parts and Accessories.....	64
The warranty does not cover any defect or damage caused by use of non-original accessories or parts.....	64
Technical Specification.....	64
Household sewing machine.....	64

INTRODUCTION

Machine Overview

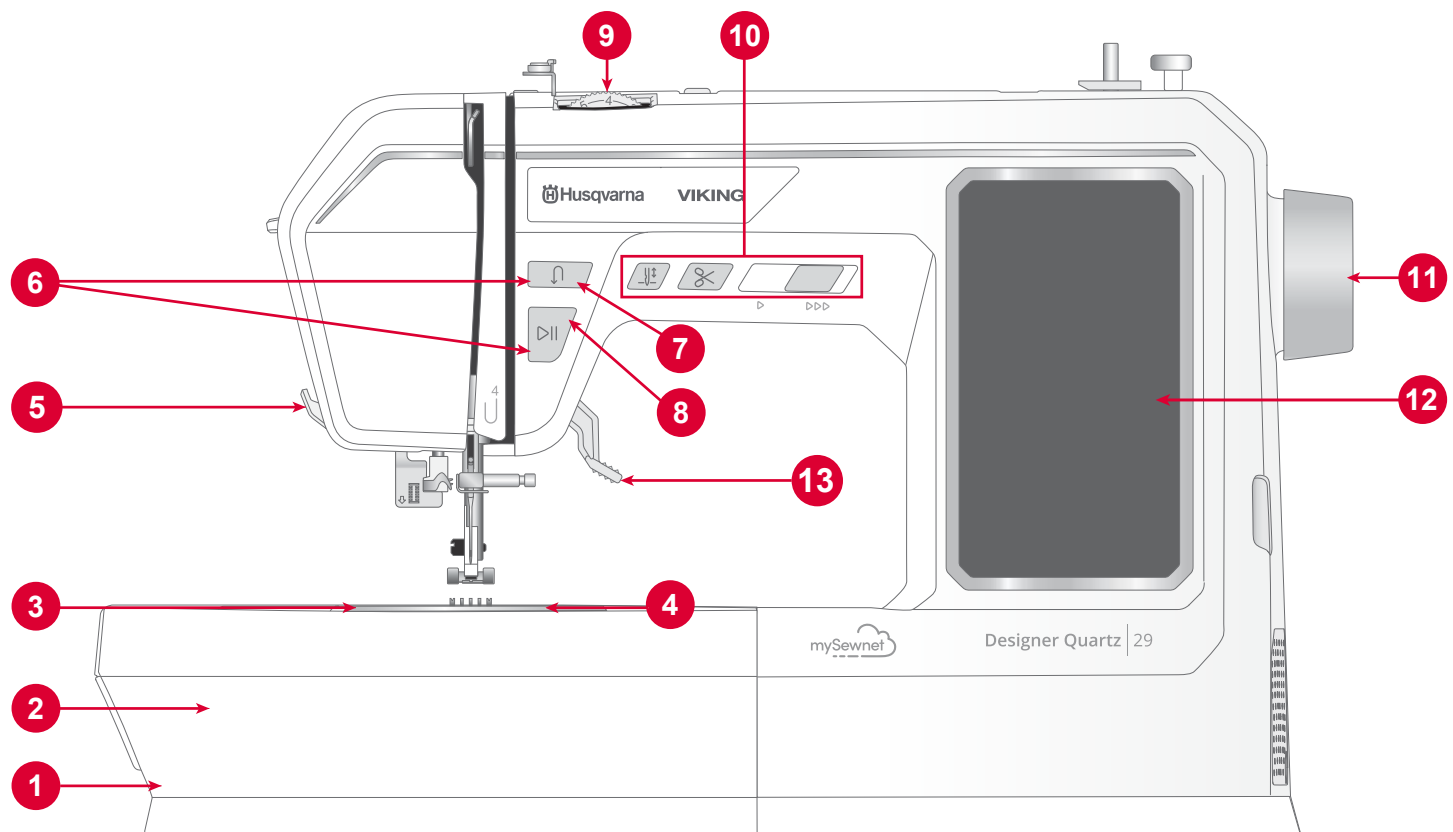

1. **Feed Teeth Lever** — Move from side to side to engage or disengage the feed teeth. Positioned at the back of the free arm, see page 23.
2. **Accessory Tray / Free Arm** — Provides a flat surface when sewing and allows storage for your accessories. Remove the accessory tray to use the free arm which makes it easier to sew, e.g., trouser hems and sleeves.
3. **Needle Plate** — Provides a flat area around presser foot for sewing. Guidelines indicate various seam allowances used to guide fabric while sewing.
4. **Bobbin Cover** — Protects the bobbin while sewing. Push the lever next to the cover to open.
5. **Thread Cutter**— For trimming thread ends at the end of sewing.
6. **Threading Slots** — Thread paths with tension discs and take up lever.
7. **Reverse Button** — Press and hold to sew in reverse or to make a tie-off, e.g., when securing the beginning or ending of a seam. *Only available straight stitch and zigzag stitch, see page 6.*
8. **Start/Stop Button** — Press to start and stop sewing without using the foot control.
9. **Thread Tension Dial** — Adjustable for setting the desired tension for your stitch, thread and fabric.
10. **Machine Operation Controls** — Functions used to make your sewing more convenient, see page 6 for more details.
11. **Hand Wheel** — Used to manually control the movement of the needle and the thread take-up lever.
12. **Touch Screen** — View and control all functions that is available on your machine.
13. **Presser Foot Lifter** — Used to raise and lower the presser foot.

Needle Area

1. **Buttonhole Lever** — Used for buttonhole sewing.
2. **Built-in Needle Threader** — Thread the needle quickly and easily.
3. **Needle Holder with Needle Clamp Screw** — Secures the needle.
4. **Needle Thread Guide** — Helps maintain thread flow when sewing.
5. **Presser Foot** — Holds fabric against feed teeth which draw fabric under the presser foot as you sew.
6. **Feed Teeth** — Feeds the fabric under the presser foot when sewing.
7. **Presser Foot Ankle** — Holds the presser foot.
8. **Presser Foot Holder Screw** — Loosen the screw to remove the presser foot holder.

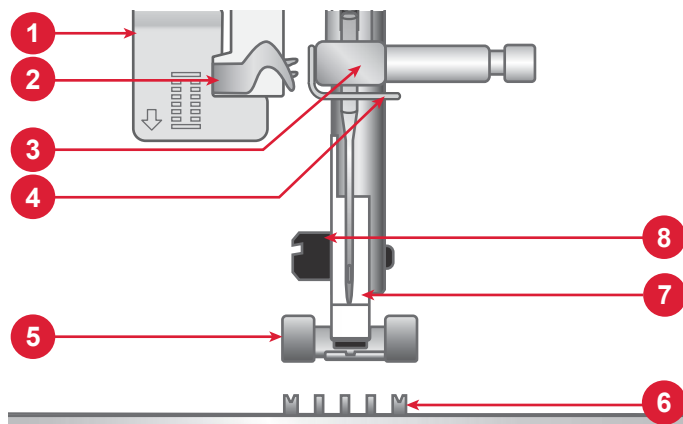

Right Side

1. USB port
2. ON/OFF switch
3. Power cord socket
4. Foot control socket

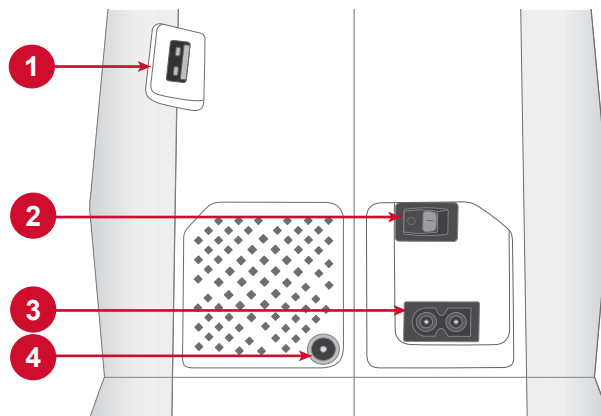

Top of Machine

1. Bobbin winding tension disc
2. Thread guides
3. Handle
4. Main spool pin
5. Bobbin winder
6. Hole for auxiliary spool pin
7. Bobbin winder lever
8. Thread tension discs
9. Thread take-up lever

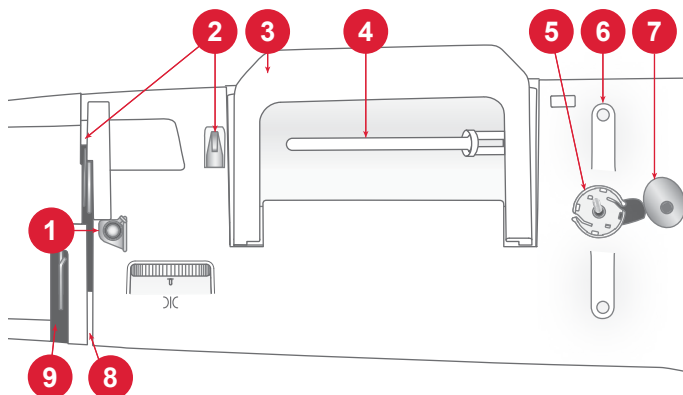

Overview Accessories

1. Bobbin x5
2. Edge/Quilting Guide
3. Spool cap x3, small, medium large
4. Thread net
5. Felt pad x2
6. Auxiliary spool pin x2
7. Multi-purpose tool
8. Screwdriver
9. Brush
10. Seam ripper
11. Stylus pen
12. Embroidery Hoop (170x100)
13. Embroidery Hoop (100x100)

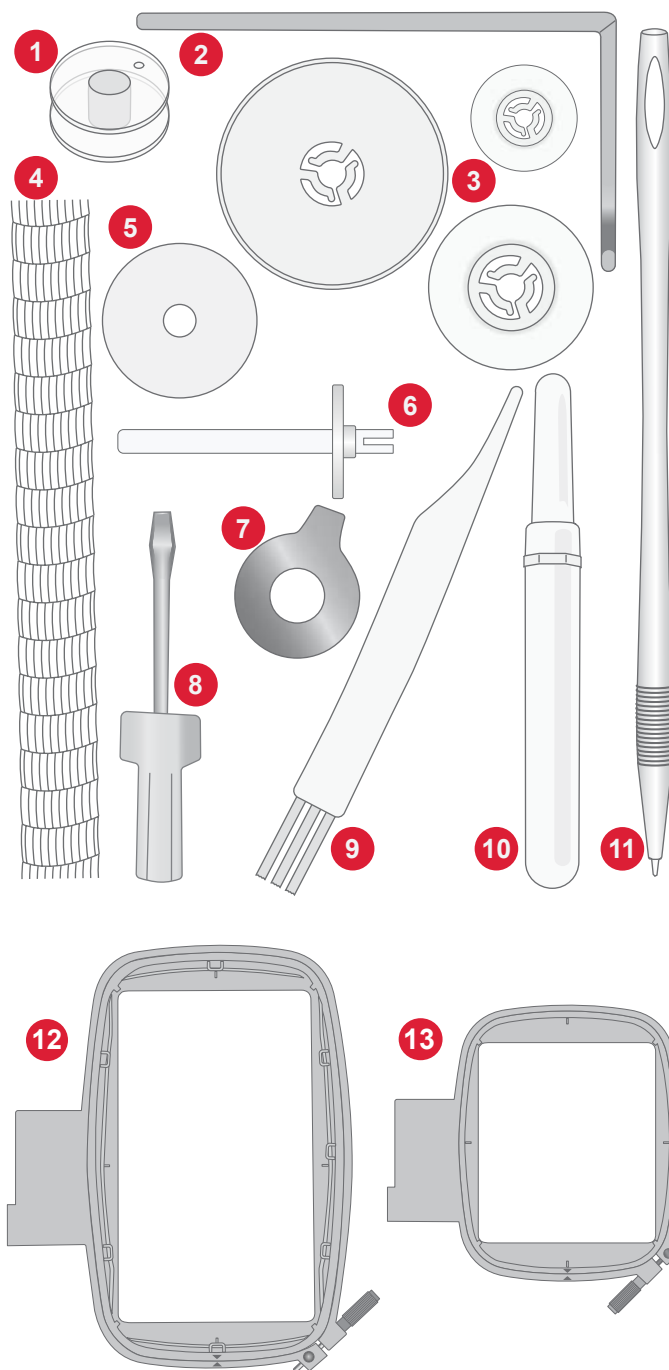

Included Accessories Not in Picture

- Needles
- Foot control
- Power cord
- Sewing Guide Reference Chart
- Chart Holder

Optional Accessories

Additional optional accessories are available for your machine. Check with your authorized HUSQVARNA® VIKING® VIKING® retailer for more information.

Presser Feet



All Purpose Foot A

(attached to the machine upon delivery)

This foot is used for general sewing on most types of fabric. The bottom of the foot is flat, so that the fabric is held down firmly against the feed teeth while sewing. It also has a wide slot so that the needle can move from left to right, depending on which stitch you sew.

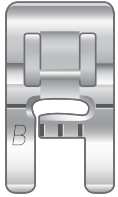

Decorative Stitch Foot B

For sewing close zigzag stitches (satin stitches) with less than 1.0mm stitch length, other utility stitches or decorative stitches, use this foot. The tunnel on the underside of the foot is designed to feed smoothly over the stitches.



Zipper Foot E

This foot is used for inserting zippers. Attach the foot to the presser foot holder on either side of the foot, depending on which side of the zipper is being sewn. The Zipper Foot can also be used to create and insert piping.



Blindhem Foot D

For blindhem stitches. The inner edge of this foot guides the fabric. The right toe of the foot is designed to ride along the hem edge.

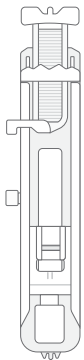

One-Step Buttonhole Foot

This foot allows you to make perfectly sized buttonholes for your button. It has a space at the back for a button, used to set the size of the buttonhole. The machine will automatically sew a buttonhole to fit that button size.

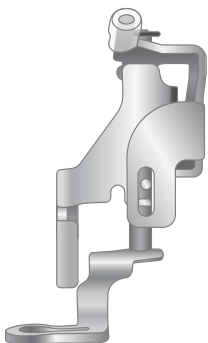

Embroidery/Free-Motion Foot

The Embroidery/Free-Motion Foot is recommended for hoop embroidery.

This foot is also great for free motion sewing when used with a straight stitch and lowering the feed dogs. It releases the fabric when the needle is in the up position, allowing you to move the fabric freely for quilting, monogramming and embroidery.



Edging Foot J

This foot is used for overcasting and seam/overcasting. Stitches form over the pin which prevents puckering at the edge of the fabric.

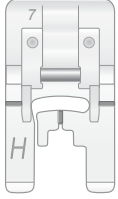

Non-Stick Glide Foot H

This foot, with a non-stick coating underneath, is used when sewing foam, vinyl, plastic, or leather to keep these materials from sticking to the foot.

Function Buttons

Reverse Button



Press and hold the Reverse button to sew in reverse. Release it to resume sewing forward. The machine sews in reverse only as long as the reverse button is pressed. *Only available for the following: straight stitch and zigzag stitch - 1-001 to 1-003, 1-008, and 1-010 to 1-012.*

Start/Stop



Press the Start/Stop button to start and stop the machine sewing or embroidering without using the foot control. Press Start/Stop to begin and touch again to stop.

Needle Up/Down



Press Needle Stop Up/Down to set the position of the needle when you stop sewing. The needle will move up or down when you touch the button.

Tip: You can also tap the foot control to raise or lower the needle once you stop sewing.

Speed Control Lever



All stitches in your sewing machine have a pre-set, recommended sewing speed. You can adjust the speed using the Speed Control Lever. Slide the lever to the left to decrease the speed and to the right to increase the speed. You cannot select a higher speed than the default max speed for the selected stitch.

Cut Function



Press the cut function button after you stop sewing and your machine cuts the top and bobbin threads.

Basic Gestures for the Touch Screen

Easily navigate on the touch screen with the gestures described below.



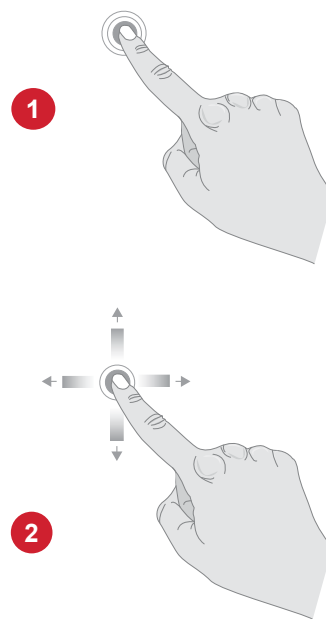





1. Touch — Touch once on a button or setting on the screen to select.
2. Touch and Move — Touch once on a selected design and, without releasing, move your finger to a different position on the screen. Used, e.g. for moving a design in the embroidery area.

























Stitch Overview

Utility Stitches

Stitch	№	Presser Foot	Thread tension	Name	Description
	1	A	3-5	Straight Stitch, center needle position	For all types of sewing. Select from 29 different needle positions.
	2	A	3-5	Straight Stitch, left needle position	For all types of sewing.
	3	A	3-5	Straight Stitch, right needle position	For all types of sewing.
	4	A	2-4	Reinforced Straight Stitch, center needle position	Triple and elastic, for reinforced seams. For top stitch, increase the stitch length.
	5	A	2-4	Reinforced Straight Stitch, left needle position	Triple and elastic, for reinforced seams. For top stitch, increase the stitch length.
	6	A	2-4	Reinforced Straight Stitch, right needle position	Triple and elastic, for reinforced seams. For top stitch, increase the stitch length.
	7	A	2-4	Decorative Straight Stitch	For decorative sewing and quilting.
	8	A	2	Basting Stitch	For temporary seams. The long stitches and reduced thread tension make the seams easy to unravel.
	9	A	2-4	Heavy Reinforced Straight Stitch, center needle position	Heavy and elastic, for reinforced seams, or decorative top stitching. For top stitch, increase the stitch length.
	10	A	3-5	Zigzag Stitch, center needle position	A very versatile stitch for decorative sewing, applique, attaching trims, and more.
	11	A	3-5	Zigzag Stitch, left needle position	A very versatile stitch for decorative sewing, applique, attaching trims, and more.
	12	A	3-5	Zigzag Stitch, right needle position	A very versatile stitch for decorative sewing, applique, attaching trims, and more.
	13	A	3-5	Three-step Zigzag	For overcasting, mending, sewing on patches and elastic. Suitable for light and medium weight fabrics.
	14	A	3-5	Two-step Zigzag	For joining two pieces of fabrics, lace insertion. Suitable for light and medium weight fabrics.
	15	B	3-5	Reinforced Zigzag Stitch	For joining fabric edge to edge or overlapping in leather. For decorative sewing.

Stitch	№	Presser Foot	Thread Tension	Name	Description
	16	B	3-5	Two-step Zigzag Stitch, Reinforced	For stretch sewing or patching. For medium and heavy fabrics.
	17	A	3-5	Elastic Stitch	For sewing seams in stretch fabrics.
	18	B	3-5	Stretch Seam/Overcast Stitch	Seam and overcast in one step along the edge or trim later. For medium stretch fabrics.
	19	B	3-5	Overcast Stitch	Seam and overcast in one step along the edge or trim later. For medium stretch fabrics.
	20	B	3-5	Seam/Overcast Stitch	Seam and overcast in one step along the edge or trim later. For medium stretch fabrics.
	21	B	3-5	Seam/Overcast Stitch	Seam and overcast in one step along the edge or trim later. For medium stretch fabrics.
	22	B	3-5	Overlock Stitch	Seam and overcast in one step along the edge or trim later. For medium stretch fabrics.
	23	B	3-5	Light Knit/Fabric Patching	For patching and sewing in light stretch fabrics.
	24	B	3-5	Flatlock Stitch	Decorative hems and overlapped seams, belts and bands. For medium/heavy stretch fabrics.
	25	B	3-5	Honeycomb Stitch	For decorative hem, and elastic shirring.
	26	B	3-5	Double Overlock stitch	Seam and overcast in one step along the edge or trim later. For medium stretch fabric.
	27	B	3-5	Elastic /Darning Stitch	For overcasting, mending, sewing on patches and elastic. Suitable for light and medium weight fabrics.
	28	B	3-5	Elastic/Casing Stitch	For overlapped seams in tricot. To sew casing over narrow elastic.
	29	B	3-5	Elastic/Casing Stitch	For overlapped seams in tricot. To sew casing over narrow elastic.
	30	B	3-5	Elastic/Casing Stitch	Sew over elastic thread for elastic shirring.
	31	B	4-6	Shell Edge Stitch	For edging, sewing over the edge on light woven fabrics.

Stitch	Nº	Presser Foot	Thread Tension	Name	Description
	32	D	3-5	Blind Hem Stitch	Sew hems that are practically invisible from the right side of the fabric. It is used for skirts, dresses, trousers, curtains, etc. For non-stretch fabric.
	33	D	2-4	Elastic Blindhem Stitch	Sew hems that are practically invisible from the right side of the fabric. For stretch fabrics.
	34	B	3-5	Herringbone Stitch	For joining two pieces of batting or fabric. For embellishment and quilting.
	35	B	3-5	Bridging Stitch	For joining two pieces of fabric with finished edges and for elastic shirring.
	36	B	3-5	Bridging Stitch	For joining two pieces of fabric.
	37	B	3-5	Decorative / Casing	For decorative casing, smocking. For medium/heavy stretch fabrics.
	38	B	3-5	Decorative / Casing	For decorative casing, smocking.
	39	A	3-5	Applique Stitch	For decorative sewing and appliqué.
	40	B	3-5	Applique Stitch	For decorative sewing and appliqué.
	41	A	3-5	Applique Stitch	For decorative sewing and appliqué.
	42	A	3-5	Applique Stitch	For decorative sewing and appliqué.
	43	A	3-5	Applique Stitch	For decorative sewing and appliqué.
	44	A	2-4	Applique Stitch	For decorative sewing and appliqué.
	45	B	2-4	Applique Stitch	For decorative sewing and appliqué.
	46	B	2-4	Blanket Stitch	For decorative sewing and appliqué
	47	A	3-5	Blanket Stitch	For decorative sewing and appliqué.

Stitch	Nº	Presser Foot	Thread Tension	Name	Description
	48	B	3-5	Satin Stitch Wide	This is a closely spaced zigzag stitch for appliqué or bar-tacking. Use a stabilizer or interfacing to avoid puckering.
	49	B	3-5	Satin Stitch	This is a closely spaced zigzag stitch for appliqué, bar-tacking, etc. Use a stabilizer or interfacing to avoid puckering.
	50	B	3-5	Satin Stitch Narrow	This is a closely spaced zigzag stitch for appliqué, bar-tacking, etc. Use a stabilizer or interfacing to avoid puckering.
	51	A	3-5	Satin Appliqué Stitch	For decorative sewing and appliqué.
	52	B	3-5	Bridging Stitch	For joining two pieces of fabric, embellishment and quilting.
	53	E	3-5	Straight Stitch Zipper Left Needle Position	For sewing zippers.
	54	E	3-5	Straight Stitch Zipper Right Needle Position	For sewing zippers.

























Stitch Menu Overview

There are several different stitch menus with stitches for all purposes.

Stitch Menu Name	Description
1 — Utility Stitches	Stitches for garment sewing and mending.
2 — Decorative Stitches	For decorative sewing.
3 — Buttonhole Stitches	Sew buttonholes on home decor, garments, crafts and more.
4 — Fonts	For decorative sewing.
5 — Saved Stitch Sequences	Find your saved stitch sequences.

Sewing Guide Reference Chart

Consult the Sewing Guide Reference Chart for a fast and easy way to select the best stitch, stitch length, stitch width, thread tension, and presser foot for your sewing technique and fabric.

															
	no.					no.					no.				
	1_001	A	3-5	0.0	2.5	1_017	A	3-5	1.0	2.5	1_001	H	3-5	0.0	3.0
	1_013	J	3-5	6.0	1.0	1_013	J	3-5	6.0	1.0	1_010	H	3-5	4.0	2.0
	1_021	J	3-5	6.0	3.5	1_020	J	3-5	6.0	3.5	1_021	H	3-5	6.0	3.5
	1_008	A	2-3	0.0	5.0	1_008	A	2-3	0.0	5.0					
	1_032	D	2-3	3.5	3.0	1_033	D	2-3	4.5	1.4					
	1_001	A	3-5	0.0	2.5	1_024	B	3-5	5.0	4.0	1_001	H	3-5	5.0	4.0
	3_006		2-4			3_006		2-4							

Recommended Settings - Overview

1. Fabric
2. Sewing technique
3. Stitch number
4. Presser foot
5. Thread tension
6. Stitch width
7. Stitch length

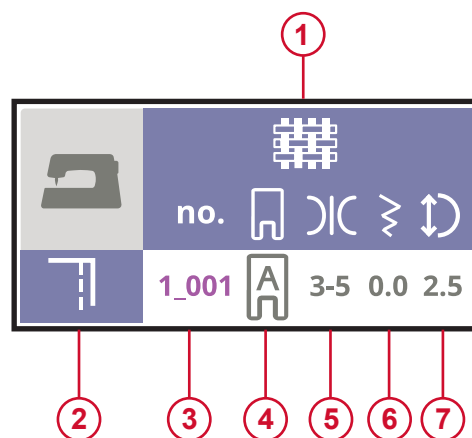

Fabrics Guide



WOVEN FABRICS: for stable fabrics that have no stretch. Usually woven.



STRETCH FABRICS: for fabrics that have stretch. Usually knit.



LEATHER/VINYL: for suede, real leather and for artificial leather and suede.

PREPARATIONS

Unpacking Machine and Embroidery Unit

After lifting the machine out of the box and removing all packing material and the plastic bag, wipe the machine, particularly around the needle and needle plate to remove any oil before sewing.

When unpacking the embroidery unit, do not throw away the white styrofoam inside the machine box, as this is designed for storing the embroidery unit when not in use.

Note: Your sewing machine is adjusted to provide the best stitch result at normal room temperature. Extreme hot and cold temperatures can affect the sewn result.

Connecting the Power Cord and Foot Control

Among the accessories you will find the power cord and the foot control.

On the bottom right side of the sewing machine, you find the connecting sockets and the ON/OFF button.

1. Connect the foot control cord to the front socket on the bottom right side of the machine (A).
2. Connect the power cord to the rear socket on the bottom right side of the machine (B). Plug the cord into the wall socket.
3. Press the ON/OFF switch (C) to "I" to turn on power and light.

Sewing speed is regulated by pressing the foot control. The maximum sewing speed can be adjusted using the Speed Control Lever.

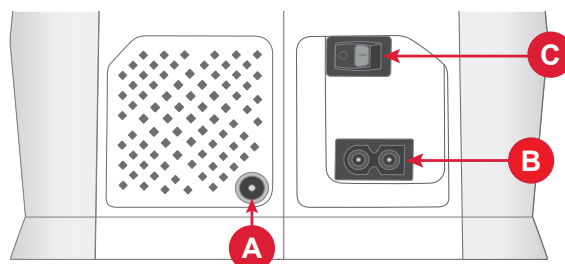

For the USA and Canada

This sewing machine has a polarized plug (one blade wider than the other). To reduce the risk of electric shock, this plug is intended to fit in a polarized outlet only one way. If the plug does not fit fully in the outlet, reverse the plug. If it still does not fit, contact a qualified electrician to install the proper outlet. Do not modify the plug in any way.

Packing Away after Sewing

1. Switch the main switch off. After switching off, residual power may still remain in the machine. This may cause the light to stay on for a few seconds while the power is consumed. This is normal behavior for an energy efficient appliance.
2. Unplug the cord from the wall socket and then from the machine.
3. Wind the cord around the foot control for easy storage.
4. Place all accessories in the accessory tray. Slide the tray on to the machine around the free arm.
5. Place the foot control and cord in the space above the free arm.

USB Port

Your machine has one USB port for connecting USB devices such as a memory stick. USB plugs can only be inserted one way – do not force them into the ports! To remove, carefully pull the USB device.

Note: You can only access your stored files on the USB in the embroidery mode.

Note: Your machine can read USB devices that are compatible with both type 2.0 and 3.0 and has the format FAT32.

Free Arm/Removable Accessory Tray

Store presser feet, bobbins, needles and other accessories in the accessory tray so that they are easily accessible.

Keep the accessory tray on the machine to provide a larger, flat work surface.

Use the free arm to facilitate sewing trouser legs and sleeve hems. To use the free arm, slide off the accessory tray. When attached, a hook keeps the accessory tray securely attached to the machine. Remove the tray by sliding it to the left.

Presser Foot Lever

The presser foot lever is located at the right side of the sewing machine head. The lever is used to raise and lower the presser foot.

By raising the presser foot lever and then pressing it farther upwards, the lift height of the presser foot is increased to an extra height allowing you to place thick fabric layers under the foot.

Thread Cutter

To use the thread cutter, pull the thread from back to front as illustrated. Doing this will leave the thread ends long enough so that the needle doesn't become unthreaded when you start to sew again.

Thread Sensor

If the needle thread breaks or bobbin thread is running low, the machine stops and a pop-up appears on the screen.

If needle thread breaks: Remove the thread completely, re-thread the machine and touch OK in the pop-up.

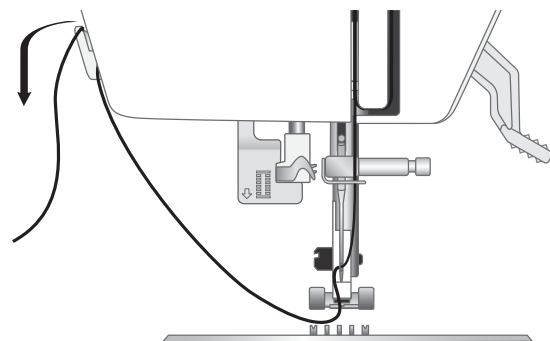
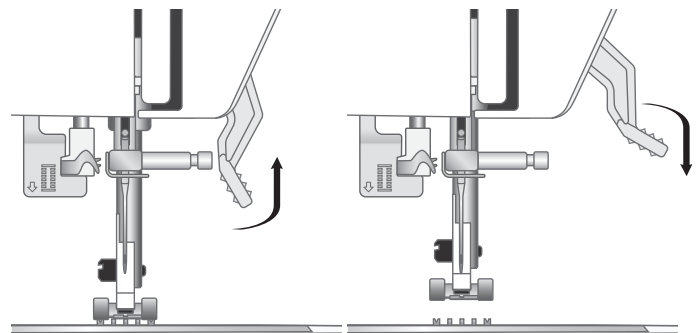
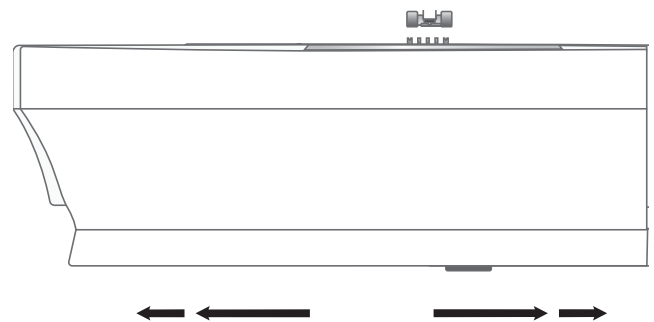

Spool Pins

Your machine has three spool pins, a main spool pin and two auxiliary spool pins. The spool pins are designed for various types of thread. The main spool pin is used in a horizontal position (the thread reels off the spool) and the auxiliary spool pins in a vertical position (the thread spool rotates). Use the horizontal position for normal threads and the vertical position or specialty threads and second thread spool when using twin needle.

Main Spool Pin

Place the thread spool on the spool pin. Make sure that the thread reels off the spool counter clockwise and slide on a spool cap. Use a spool cap slightly larger than the thread spool. For narrow thread spools (A), use a smaller spool cap in front of the spool. For large thread spools (B), use a larger spool cap in front of the spool. The flat side of the spool cap should be pressed firmly against the spool. There should be no space between the spool cap and the thread spool.

Note: Not all thread spools are manufactured in the same way. If you experience problems with the thread, turn it in the opposite way or use the vertical position.

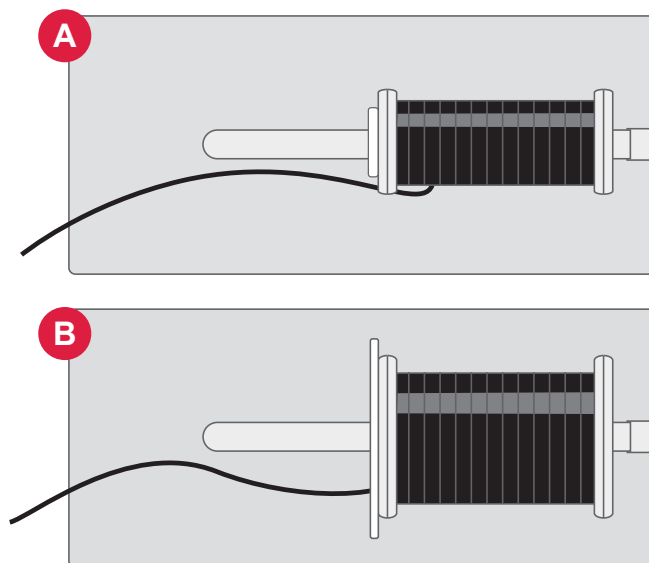

Auxiliary Spool Pin

The Auxiliary Spool Pins are used when winding a bobbin thread from a second spool of thread, or when sewing with specialty threads or a twin needle. Two Auxiliary Spool Pins are included with your machine. To use, insert an Auxiliary Spool Pin into the designated hole at the top of the machine. Place a felt pad under the thread spool to prevent the thread from reeling off too quickly. Do not place a spool cap on top of the spool pin, as this would prevent the spool from rotating properly.

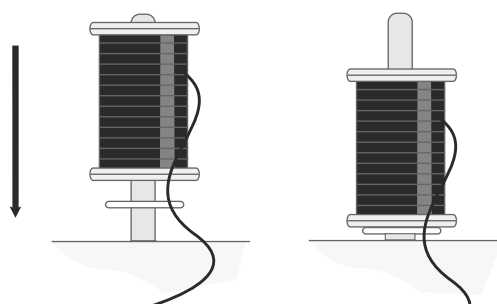

Spool Caps

Spool caps in three sizes are included with your machine. If the thread is snagging on the top of the thread spool, place a spool cap on top. Always use a spool cap slightly larger than the thread spool to prevent the thread from snagging. The flat side of the spool cap should be pressed firmly against the spool. There should be no space between the spool cap and the thread spool.

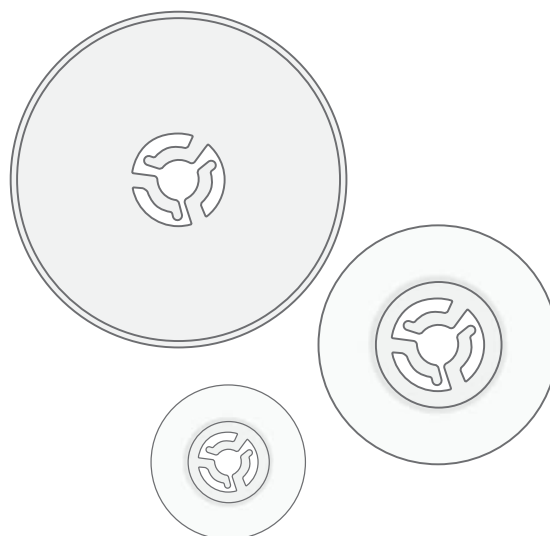

Threads

There are many threads on the market today developed for different purposes.

Your machine is designed for different types of threads and spool sizes.

All Purpose Sewing Thread

All purpose sewing thread is made of synthetic, cotton or cotton covered polyester. This type of thread is used for most sewing projects, including garments, home decor, and quilting.

Embroidery Thread

Embroidery thread is made from a variety of fibers: rayon, polyester, acrylic or metallic. These threads create a smooth glossy appearance for embroidery and other decorative stitching.

It is recommended to use embroidery thread for the best results when embroidering.

Note: When using a metallic or a flat film thread for embroidery, you may need to use a needle with a larger eye and lower the embroidery speed.

Transparent Thread

Transparent thread, also called monofilament thread, is a single clear synthetic thread. It is used for quilting and other decorative sewing. When winding a bobbin, wind at half speed and fill the bobbin half full.

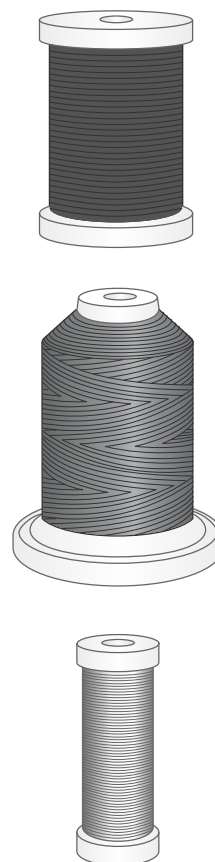

Stabilizers

Tear-Away Stabilizers

Tear-away stabilizers are used with stable woven fabrics. Hoop with the fabric when embroidering. Tear away excess stabilizer after stitching.

Iron-on Tear-Away

Iron-on tear-away is a more stable stabilizer that has a slick side that will iron on to fabric. It is recommended for knits and all unstable fabrics. Fuse it to the wrong side of the fabric before hooping. Tear away excess stabilizer after stitching.

Cut-Away Stabilizer

Cut-away stabilizer does not tear so the excess has to be cut away. It is recommended for hoop embroidery on knits and all unstable fabrics.

Water Soluble Stabilizer

Water soluble stabilizer is placed on top of the fabric when embroidering napped and looped fabrics such as terry cloth. When embroidering cutwork, use it underneath the fabric. Place your work in water to dissolve the excess stabilizer. It is available in different thicknesses.

Heat Soluble Stabilizer

Disintegrating stabilizer is a stable, loosely woven fabric that is used for techniques such as cutwork and to embroider off the fabric edge. The stabilizer disappears with heat.

Sticky Stabilizer

Sticky stabilizer is used for hoop embroidery when the fabric is too delicate or too small to be hooped. Hoop the sticky stabilizer with the paper side up. Remove the paper and stick the fabric onto the sticky surface. Tear away sticky stabilizer.

Needles

The sewing machine needle plays an important role in successful sewing. Use only quality needles. We recommend needles of system 130/705H. The needle package included with your machine contains needles of the most frequently used sizes.

 Be sure to match the needle to the thread you are using. Heavier threads require a needle with a larger needle eye. If the needle eye is too small for the thread the needle threader may not work properly.

 **Universal Needle**
Universal needles have a slightly rounded point and come in a variety of sizes. For general sewing in a variety of fabric types and weights.

 **Stretch Needle**
Stretch needles have a ball point and a special scarf to eliminate skipped stitches when there is a flex in the fabric. For knits, swimwear, fleece, synthetic suedes and synthetic leathers.

 **Denim Needle**
Denim needles have a sharp point to penetrate tightly woven fabrics without deflecting the needle. For canvas, denim, microfibers.

 **Embroidery Needle**
Embroidery needles have a special scarf, a slightly rounded point and a slightly larger eye to avoid damage to thread and materials. Use with metallic and other specialty threads for free-motion embroidery and decorative sewing.

 To help prevent needle breakage, use only medium/low sewing speed and the recommended needle for sewing thick fabrics.

Important Needle Information

 Change the needle often. As a general rule, needles should be changed every 6-8 hours of actual stitching time.

Always use a straight needle with a sharp point and make sure the point is not bent or damaged (A).

A damaged needle (B) can cause skipped stitches, breakage or snapping of the thread. It can also damage the needle plate.

Do not use asymmetrical twin needles (C), they can damage your sewing machine.

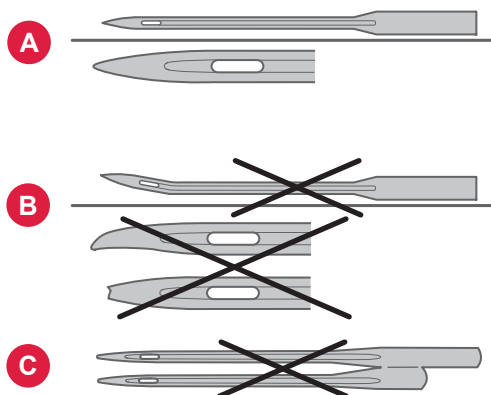

Changing the needle

Note: Before you begin changing the needle, it can be helpful to place a small piece of paper or fabric underneath the needle area, over the hole in the needle plate, so that the needle doesn't accidentally fall down into the machine.

1. Loosen the needle clamp screw. If it feels tight, use the multi-purpose tool from your accessories to aid with loosening the screw.
2. Remove the needle.
3. Push the new needle upwards into the needle clamp with the flat side of the needle away from you.
4. When the needle will go up no further, tighten the screw securely.

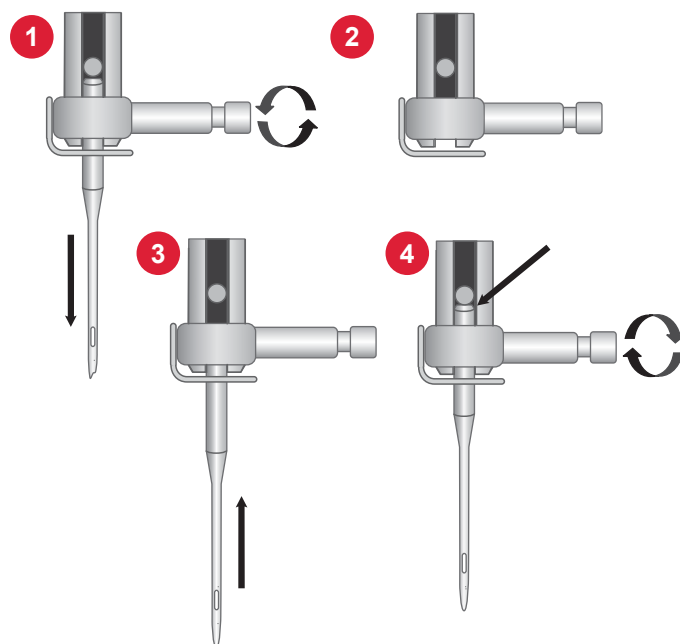

Selection Guide — Needle Size, Fabric, Thread

Needle Size	Fabric	Thread
70 (9) 80 (12)	Lightweight fabrics: Fine cotton, voile, silk, muslin, interlock, tricot, jersey, crepe, polyester, chiffon, organza, organdy	Light duty all purpose thread
80 (12) 90 (14)	Medium weight fabrics: Quilting cotton, satin, double knit, lightweight wool, rayon, polyester, lightweight linen	Use polyester threads on synthetic fabrics and all-purpose or cotton thread on natural fabrics for best results.
90 (14)	Medium weight fabrics: Firm woven, medium weight linen, cotton/polyester blend, terrycloth, chambray, double knit	
90-110 (16)	Heavy weight fabrics: Canvas, wool, denim, home decor, fleece, heavy knit	Polyester or all-purpose thread
110 (18)	Heavy weight fabrics: Coat weight wool, upholstery fabrics	Heavy duty thread for needle, with all-purpose thread for the bobbin.

Bobbin Winding

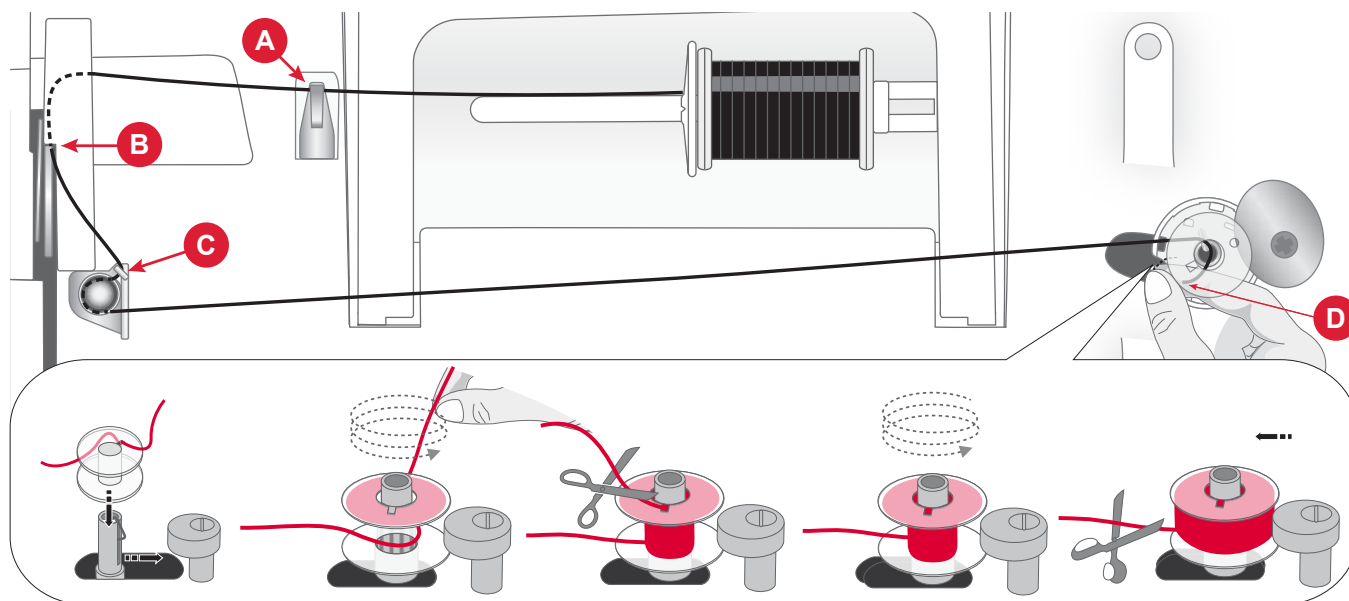

1. Place the thread spool on the spool pin. Slide a spool cap firmly against the spool.
 2. Pull the thread into the thread guide (A) from front to the back and thread guide (B) from back to front.
 3. Bring the thread around the bobbin winding tension disc (C), making sure that the thread is pulled snugly between the discs.
 4. Place the bobbin on the bobbin winding spindle. Make sure the bobbin is pushed down firmly.
 5. Bring the thread clockwise around the bobbin and place it through the Thread Cutter located under the bobbin winding spindle (D).
 6. Push the bobbin winding spindle to the right. When the winding spindle is pushed to the right, a bobbin winding pop-up is shown on the display. Press the Start Button to start winding.
 7. Press the Start/Stop Button to pause the winding if needed. When the bobbin is full press the Start/Stop Button.
- Note: You can also start the winding by using the foot control.*
8. Push the bobbin winding spindle to the left. Remove the bobbin and cut the thread by using the Thread Cutter located under the bobbin winding spindle (D).

Note: When the bobbin winding spindle is pushed to the right, the machine will not sew. Make sure to push the bobbin spindle back to the sewing position (left) before sewing.

Inserting the Bobbin

Note: Make sure that the needle is fully raised and the machine is turned off before inserting or removing the bobbin.

1. Remove the bobbin cover (A) by pushing the small button to the right of the cover (B) towards the right.
2. Insert the bobbin in the bobbin case with the thread running in a counterclockwise direction.
3. With the tip of your finger on the bobbin, pull the thread slightly to the right and under the guide (C) then towards the left.
4. Continue guiding the thread up toward the left and around the curve (D).
5. Bring it down the channel toward the front and into the bobbin Thread Cutter (E). Replace the bobbin cover and pull the thread to the right to cut off the excess thread.

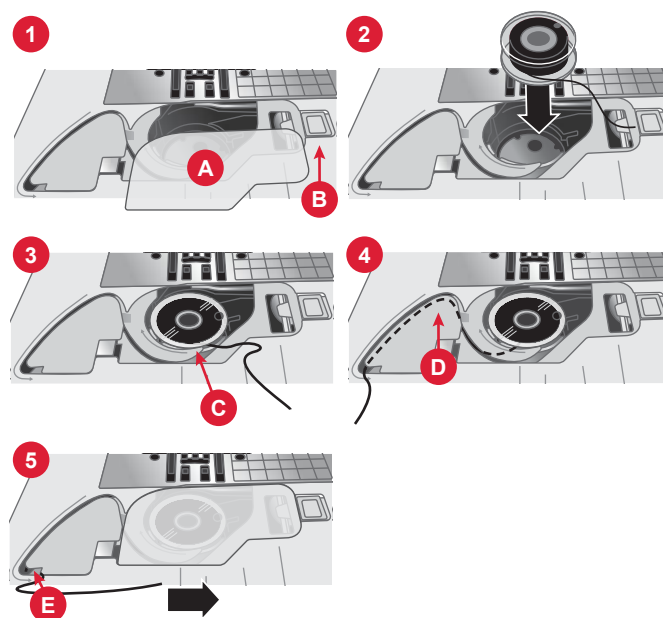

Threading the Upper Thread

Important! Make sure that the presser foot is raised and the needle is in its highest position by turning the handwheel toward you. This is very important to help ensure that the machine is correctly threaded. Not doing so can result in poor stitch quality when you start to sew.

1. Place the thread on the spool pin and fit the appropriately sized spool cap.
2. Pull the thread into the thread guide (A) from front to the back and thread guide (B) from back to front.
3. Pull the thread between the tension discs (C).
4. Continue bringing the thread down through the right threading slot, around the U-turn, then back upwards through the left threading slot.
5. Bring the thread from the right into the take-up lever (D).
6. And then bring the thread down in the left-hand threading slot and to the needle thread guide (E).
7. Thread the needle from front to back.

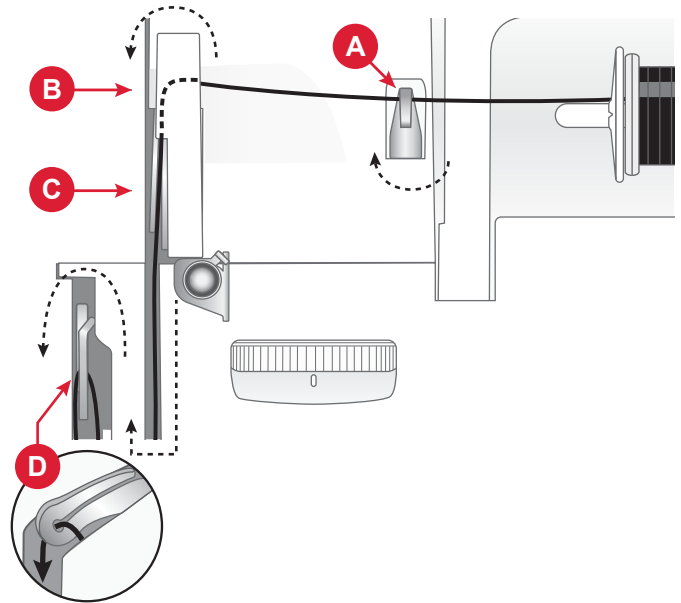

Machine from above

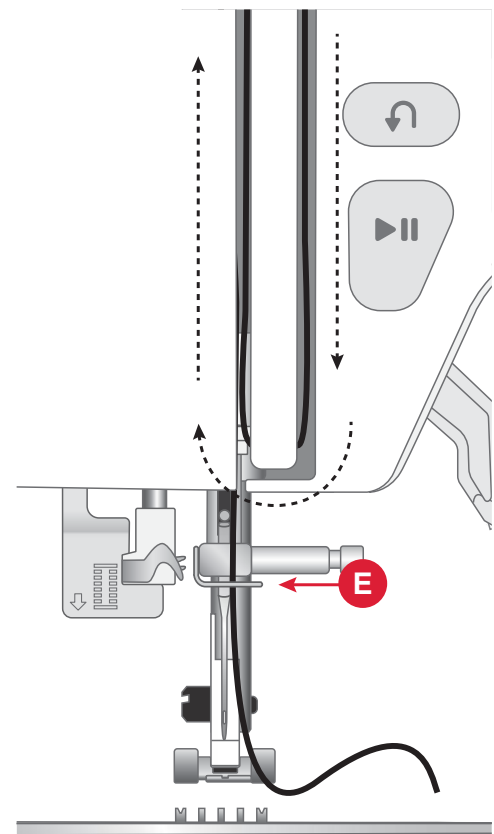

Machine from front

Using the Needle Threader

The built-in needle threader allows you to thread the needle quickly and easily.

The needle must be in its highest position to use the built-in needle threader. Turn the hand wheel towards you until the needle is in its highest position. It is also recommended that you lower the presser foot.

1. Use the lever (A) on the left side of the sewing head to pull the needle threader all the way down. The metal flanges cover the needle. A small hook will pass through the needle eye (B).
2. Keep the needle threader lever down (C).
3. Place the thread from the right over the thread guide (D) and under the small hook (E).
4. Gently release the needle threader lever (F). The hook pulls the thread through the needle eye and forms a loop behind the needle. Pull the thread loop out behind the needle.
5. Raise the presser foot and place the thread under it.
6. Pull out about 4" (10cm) of thread beyond the needle eye. This will prevent the machine from coming unthreaded when you start to sew.

Note: The needle threader is designed to be used for size 70-110 needles. You cannot use the needle threader for size 60 needles or smaller, or twin needles. There are also some optional accessories that require manual threading of the needle. When threading the needle manually, make sure that the needle is threaded from front to back.

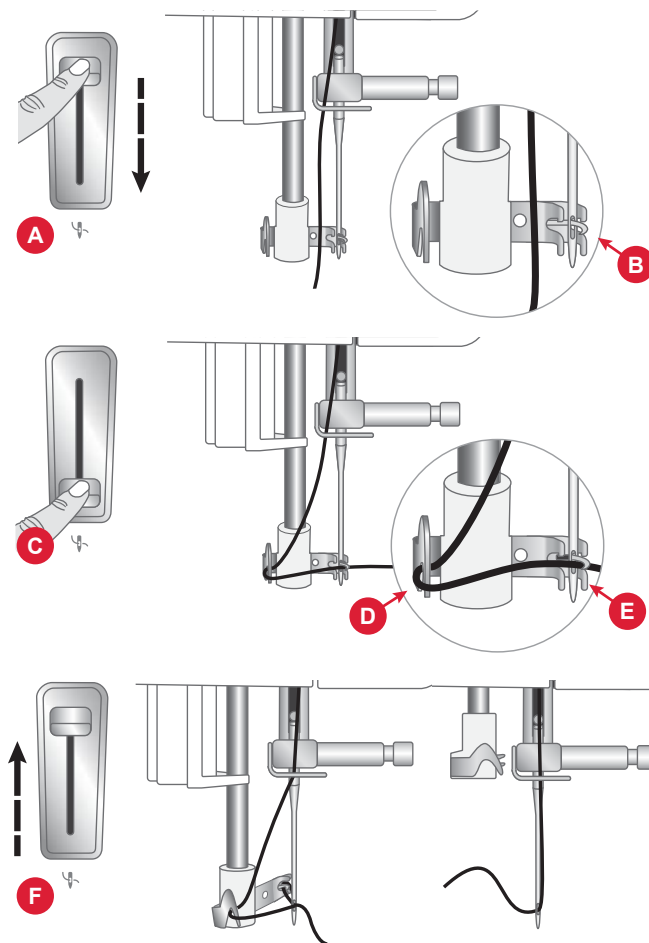

Threading Tips and Hints

There are many threads on the market today developed for different purposes. The quality and structure of the thread as well as the shape and size of the thread spool can affect the behavior of the thread. Threads can also behave differently if the spool is full or nearly empty.

If experiencing problems, try the tips and hints below.

Note: Always test sew on a scrap piece of fabric to check the sewing result.

If the Thread Spool is Pulled up on the Spool Pin

When the thread on the spool is running low, the thread can snag on the edge of the spool and pull the spool up on the spool pin. Place a spool cap on top of the thread spool to keep it in place. Always use a spool cap slightly larger than the thread spool to prevent the thread from snagging. The flat side of the spool cap should be pressed firmly against the spool. There should be no space between the spool cap and the thread spool.

If the Thread Slides Down on the Standing Thread Spool

If the thread is of a quality that unwinds easily and slides down on the standing thread spool it can get caught under the thread spool around the spool pin and break. Place the large spool cap on the spool pin with the flat side up before placing the thread spool.

If the thread spool has the same diameter as the large spool cap, place a thread net from below over the spool before placing it on the spool pin.

Threading for Twin Needle

1. Replace the sewing needle with a twin needle. Make sure that the presser foot and needle are in the up position.
2. Place the auxiliary spool pins in the designated slots on the top of the machine, then add the felt pads for more stability.
3. Place the threads on the spool pins
4. Pull the threads into the thread guide (A) from front to the back and thread guide (B) from back to front.
5. Pull the threads between the tension discs (C).
6. Continue bringing the thread down through the right threading slot, around the U-turn, then back upwards through the left threading slot.
7. Bring the thread from the right into the take-up lever (E).
8. And then bring the threads down in the left-hand threading slot and to the needle thread guide (D). One thread should be placed inside the needle thread guide (D) and the other one outside. Make sure the threads do not become twisted together.
9. Thread the twin needle manually from front to back.
10. Touch the Single/Twin Needle button for optimal results when sewing with a twin needle.

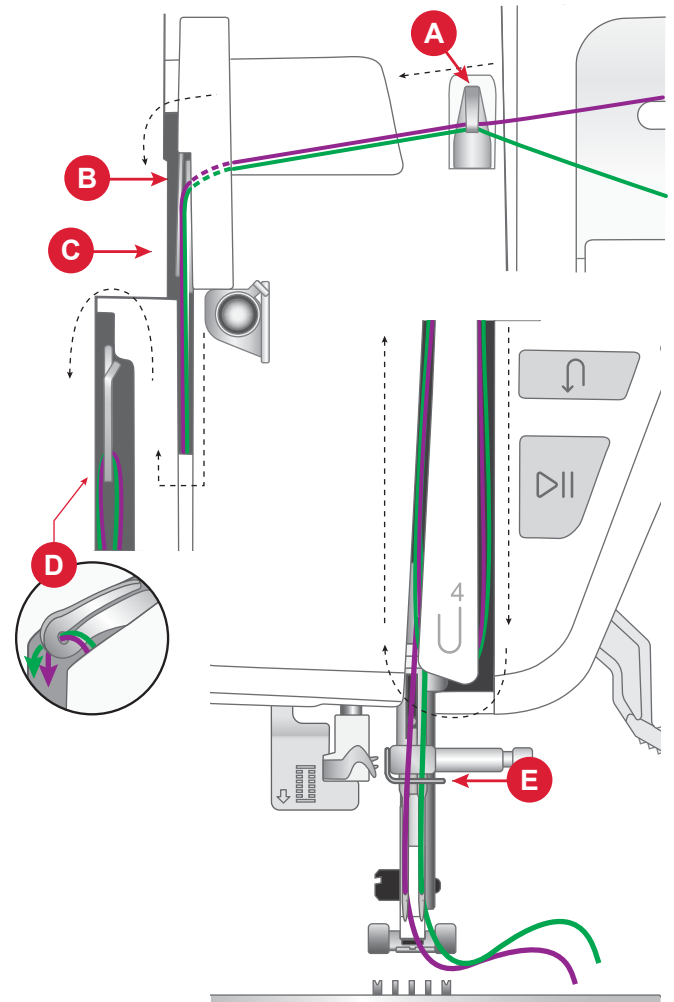
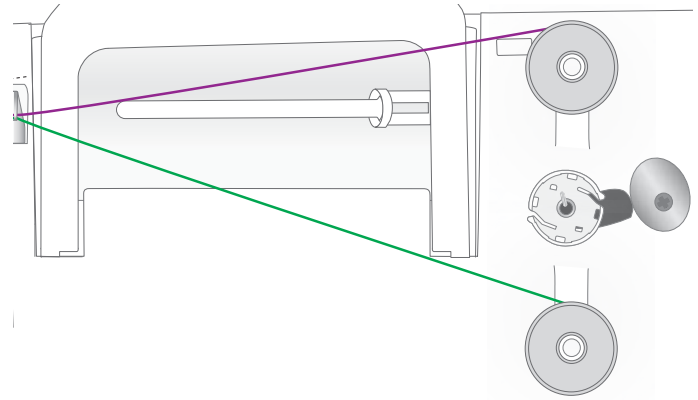

Thread Tension

To set the thread tension, turn the dial on top of the machine. Depending on the fabric, thread, etc, the tension may need to be adjusted. For the best stitch appearance and durability, make sure the needle thread tension is correctly adjusted. For general sewing, the threads evenly meet between the two layers of fabric (A).

If the bobbin thread is visible on the top side of the fabric, the needle thread tension is too tight (B). Reduce the needle thread tension.

If top thread is visible on the underside of the fabric, the needle thread tension is too loose (C). Increase the needle thread tension.

For decorative stitches and buttonholes, the top thread should be slightly visible on the underside of the fabric.

Make a few tests on a scrap piece of the fabric you are going to sew and check the tension.

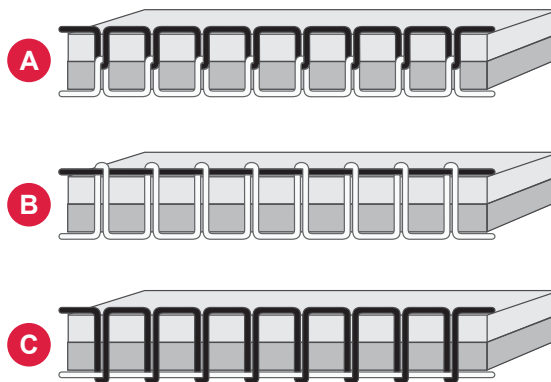

Sew without Feed Teeth

When sewing on buttons or doing other sewing techniques where you don't want the fabric to feed, you need to lower the feed teeth.

The feed teeth lever is found at the back of the free arm.

1. Lower the feed teeth by moving the lever to the “Feed Teeth Down” position.
2. Raise the feed teeth by moving the lever to the “Feed Teeth Up” position.

Note: The feed teeth will not raise immediately when the lever is switched. Turn the hand wheel toward you one full turn or start sewing to re-engage the feed teeth.

Changing the Presser Foot

1. Make sure that the needle is in the highest position. Pull the presser foot down and towards you.
2. Line up the pins on the foot with the gap underneath the presser foot holder. Press upwards until the foot snaps into place.

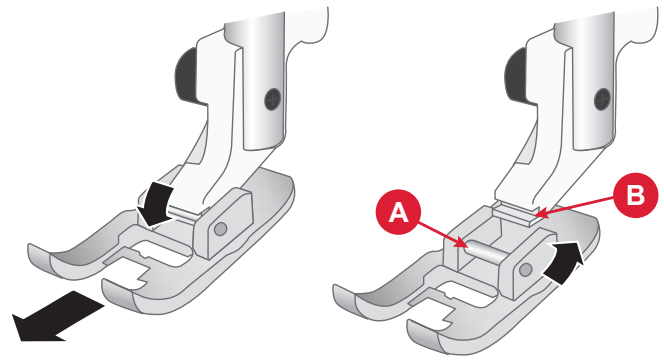

Attaching the Embroidery Foot

1. Using the screwdriver, remove the presser foot ankle.
2. Position the Embroidery Foot onto the presser foot bar from behind, lining the hole on the foot up with the hole on the presser foot bar. Lower the needle into the opening of the foot by turning the handwheel towards you. The arm of the presser foot should rest on top of the needle screw.
3. Insert and tighten the presser foot ankle screw using the screwdriver.

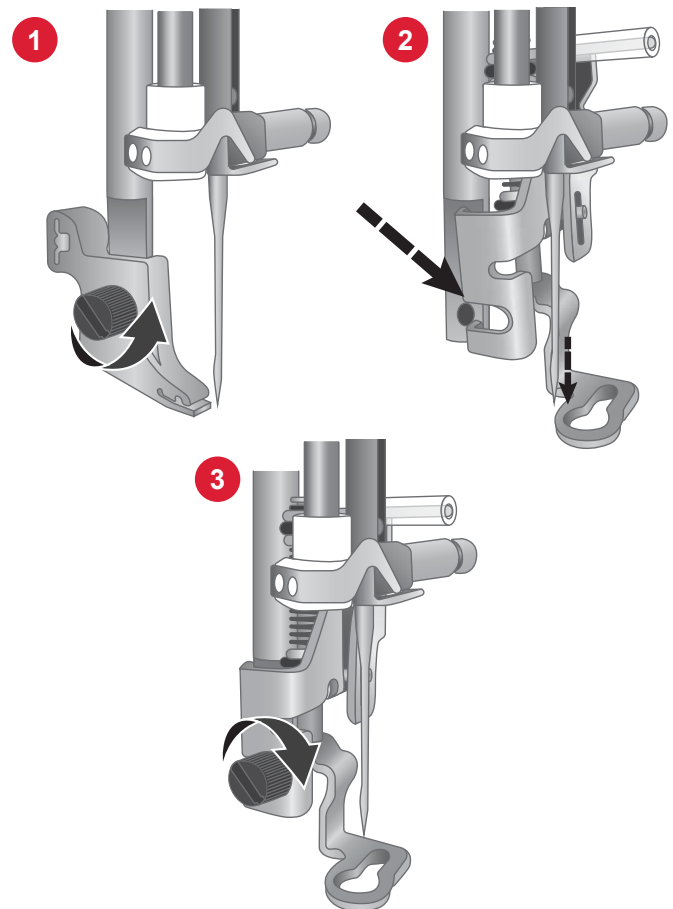

EMBROIDERY PREPARATIONS

Embroidery Unit Overview

1. Embroidery arm
2. Embroidery hoop attachment
3. Embroidery unit plug
4. Embroidery unit release button (underside)

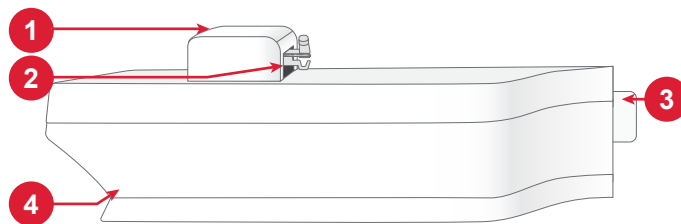

Embroidery Hoop Overview

1. Embroidery hoop connector
2. Outer hoop
3. Inner hoop
4. Center marks
5. Retaining screw

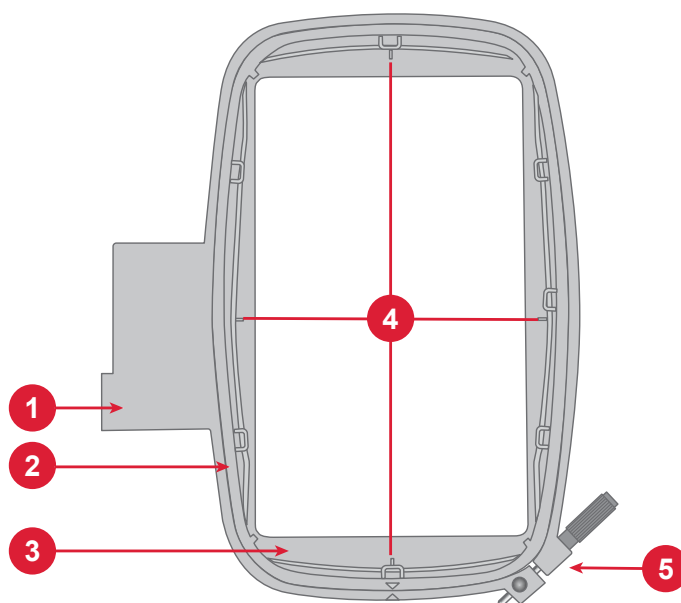

Embroidery Foot

The Embroidery Foot is recommended for hoop embroidery and free-motion sewing. See Attaching the Embroidery Foot on the previous page.

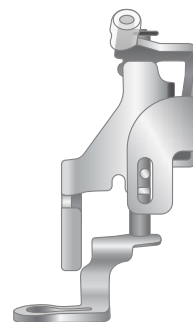

Designs

180 designs are included in the machine memory. These designs, along with the ten built-in embroidery fonts, are shown on the screen in the Embroidery Mode.

Note: Your machine can only load embroidery files in the .VP3 format.

Connecting the Embroidery Unit

When embroidering always place your sewing machine and embroidery unit on a single, flat, and sturdy surface. Make sure there is enough space around your machine as the embroidery arm and hoop will move and take up a lot of room.

1. Slide the accessory tray off.
2. Slide the embroidery unit onto the free arm of the machine until it plugs firmly into the socket at the front of the machine.
3. After sliding the embroidery unit on, a pop-up message tells you to clear the embroidery area and remove the hoop before calibration. Touch OK. The machine will calibrate and the embroidery arm will move to the ready position. The machine enters the embroidery mode every time the unit is attached.

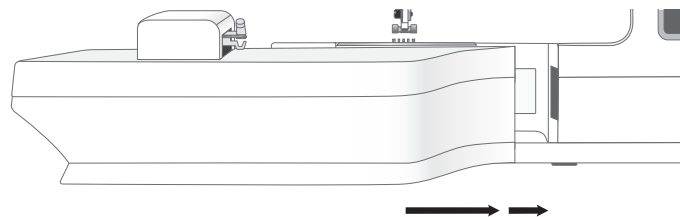

Removing the Embroidery Unit

1. Press the button at the left, underneath the embroidery unit (A) and slide the unit to the left to remove it.
2. Store the embroidery unit in the original white styro-foam packing material.

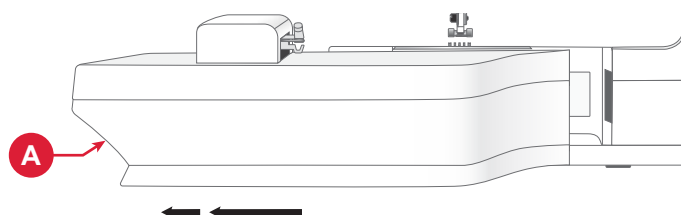

Hooping the Fabric

For the best embroidery results, place a layer of stabilizer beneath the fabric. When hooping stabilizer and fabric make sure that they are smooth and securely hooped.

1. Loosen the screw (A) on the larger outer hoop. Remove the inner hoop. Place the outer hoop on a firm flat surface with the screw on the lower right. There is a small arrow in the center of the lower edge of the hoop (B) which will line up with a small arrow on the inner hoop.
2. Place the stabilizer and fabric, with the right sides facing up, on top of the outer hoop. Place the inner hoop on top of the fabric with the small arrow at the bottom edge. If you can see the hoop size in the lower part of the inner hoop, you have attached it correctly.
3. Push the inner hoop firmly into the outer hoop.
4. Tighten the hoop screw (A). The fabric should be taut in the hoop for the best results.

Note: Be sure to loosen the hoop screw enough for the fabric and stabilizer thickness so you can easily push the inner hoop in place. Push in on the sides of the inner hoop to be sure both hoops are even.

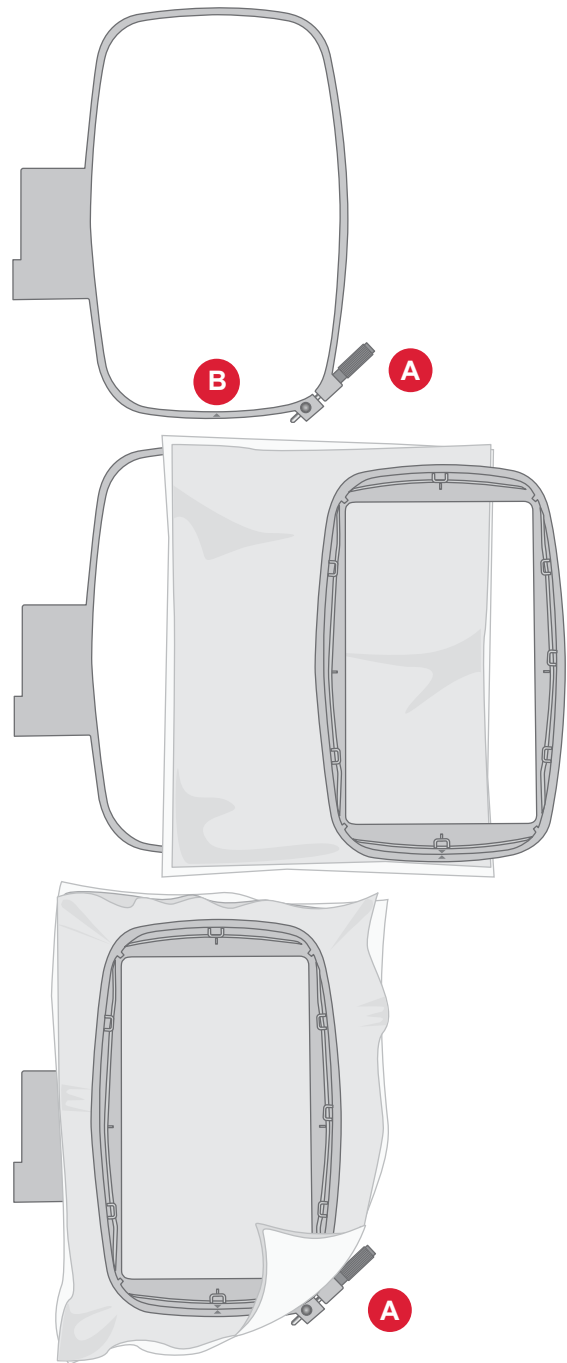

Attaching and Removing the Hoop

1. Slide the hoop connector into the hoop attachment (A) from front to back until it clicks into place.
2. To remove the hoop from the embroidery arm, press the grey button (B) on the hoop attachment and slide the hoop towards you.

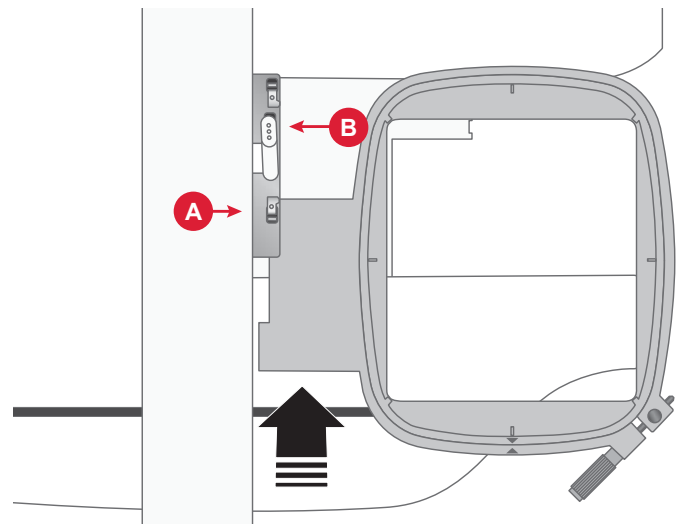

THE TOUCH SCREEN

Common Functions

The following functions on the screen are used frequently.

OK

Confirms changes and pop-up messages and returns to previous window.



Cancel

Cancels changes and pop-up messages and returns to previous window.



Settings

Touch Settings Button to open the settings window.

Settings that are recommended will automatically be set when loading stitches and/or designs.



Machine Settings

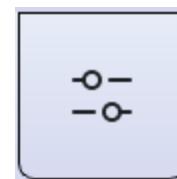

Embroidery / Sewing Settings

SETTINGS

Machine Settings

Touch the settings icon in the top right corner to access the machine settings. Most settings made in the machine settings will be saved, even when turning your machine off.

Language

Select your desired language on the screen. All texts in the machine will be changed.

Save from USB

Import files from your USB to the machine storage.

Save to USB

Export files from the machine storage to your USB.

Settings

View additional settings available depending on if you are in sewing mode or embroidery mode.

Firmware

View and upgrade your machine firmware.

Lock Screen

If there is the possibility of bumping the screen and changing the stitch or settings while sewing, it is easy to lock the screen.

Hoop Options

To select a different hoop size, touch the hoop selection button. A list will appear with hoop choices, including hoops that are available to purchase from your authorized HUSQVARNA® VIKING® VIKING® retailer.

Clear Download Cache

Touch the Clear Download Cache button to remove all saved files from the machine memory to free space.

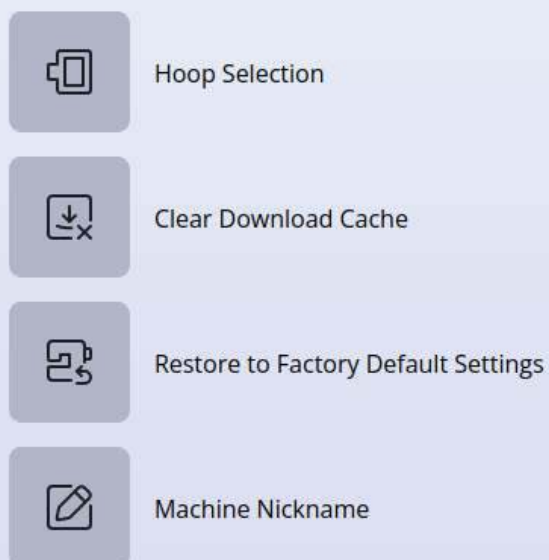
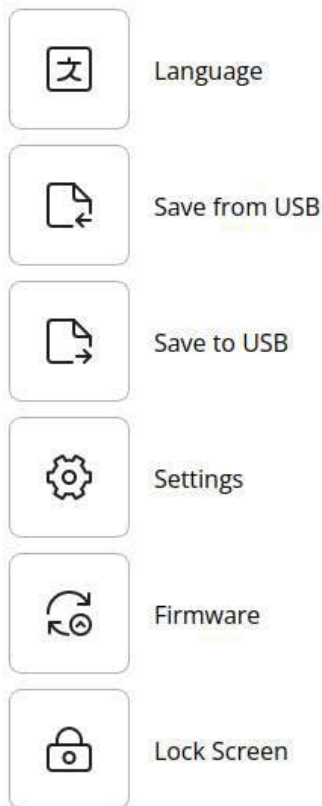

Restore to Factory Default Settings

Restoring your sewing machine to factory default settings erases any changes or adjustments made to the machine's settings, essentially resetting it to its original state. This can be a useful troubleshooting step for resolving issues, but it will also erase any saved settings or configurations.

Machine Nickname

Touch to select a nickname for your machine.

Embroidery and Sewing Settings

There are additional settings available to enhance your sewing or embroidery experience. Any changes made to the settings in either mode will be saved automatically, even if you turn off the machine. You can access these settings under the additional settings tab in the machine settings menu.

Activate Screensaver (min)

To activate the screensaver, touch the button and select how many minutes of inactivity should pass before the screensaver turns on.

Auto Power Off

Your machine will automatically turn off after a duration of time due to inactivity. The current state will be saved and possible to restore when the machine is turned on again. You will get a notification before the machine is turned off. You can change the duration of time before your machine turns off in settings.

To reactivate the sewing machine after it has automatically powered off, press any physical button on the machine. If you need to manually switch the machine off and then back on, ensure there is a long interval between these actions to allow the machine to reset properly.

Audio

Turns on or off all sounds of the machine. Default setting is on. This setting is saved even if the machine is turned off.

Detect Thread Break

Turn on the Detect Thread Break function to choose if you want the machine to notify you when the thread breaks. You will be notified by a pop-up message.

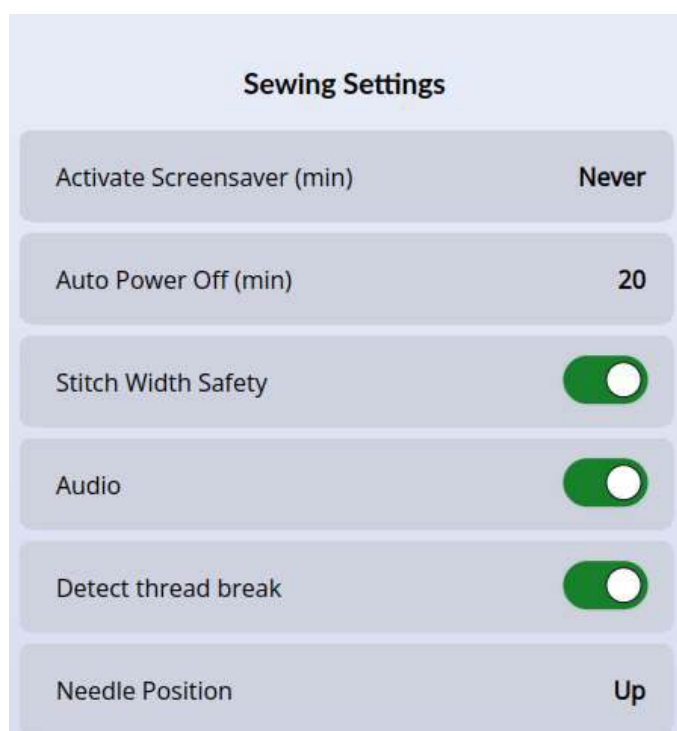
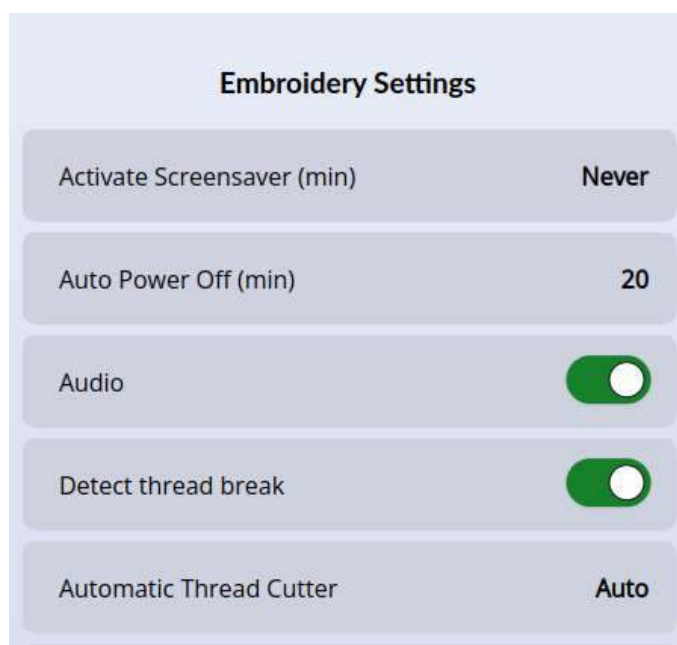

Automatic Thread Cutter

When selected, the threads are cut automatically after sewing a sequence or after sewing a single stitch e.g. a monogram or eyelets. If deselected, no automatic thread cut will be performed.

Needle Position

Select if you want your needle up or down when the machine stops sewing.

Firmware Update Using a USB Device

It is always recommended to install the latest firmware in your machine.

Visit the HUSQVARNA® VIKING® VIKING® website at www.husqvarnaviking.com and find your machine. Here you will find the available updates. Follow the steps below to download and install the firmware update.

1. Download the update firmware zip file. Unzip the file and copy the file (.clo) to a USB device.

Note: Do not change the name of the file or do not copy the file into an existing folder on the USB device. Make sure that the name of the file is "sg_firmware_update.clo".

Note: Make sure that there is no old firmware update file (.clo) on the USB stick when copying the new firmware update file (.clo). The file name is not unique.

2. Connect the USB device loaded with the new firmware version to a USB port on your machine.
3. Turn on your machine with the ON/OFF switch and touch the Menu Button.
4. Touch the firmware button. After the firmware update is verified, touch 'Install'. Do not turn off the machine.
5. Restart the machine when the update is completed. Check the software version number in the settings menu under the firmware page.

Note: Make sure that the USB stick you use has the format FAT32.

WiFi Introduction

Your machine features WiFi which makes it possible to connect your machine wirelessly to the mySewnet services. Follow the steps below to connect your machine.

Getting Started with WiFi

Touch the mySewnet button in the top bar, and then the Settings Button in the top corner or bottom corner of the screen. Select from the list of available networks. If your network is password protected, you will be prompted to enter the password to connect. Touch the information icon to open an information pop-up about the network. You can also see the signal strength and if the network is password protected, indicated with a closed padlock.

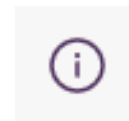

Other Network

Touch the button to connect to another network. A pop-up will be shown on the screen where you can enter the name of the other network.

Firmware Update Using WiFi

To be able to get the latest firmware wirelessly you need to connect to a network using WiFi. When connected, your machine will automatically search for available firmware update. If the machine has detected that there is a newer firmware available, the firmware update button will be visible in the mySewnet settings. Touch the button to download and install the latest firmware.

Restart the machine when the update is completed. Check the firmware version number in the mySewnet settings.

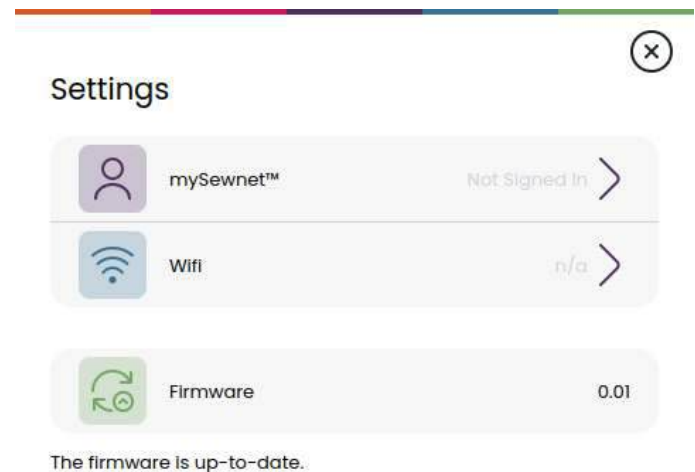

Complementary Software (PC and MAC)

A computer software package is available for your machine. It adds the following features:

- The mySewnet cloud sync tool allows you to synchronize your content in the mySewnet cloud with a folder on your computer. Drag and drop files to the folder on your computer and the files will automatically be transferred to the mySewnet cloud.
- Plug-in for your File Explorer to handle embroidery designs: viewing designs as thumbnail images, reading different embroidery file formats, add trim commands and more.

Visit the mySewnet™ website at www.mysewnet.com to get support and to download the software.

More information and detailed installation instructions are available on the download page.

mySewnet Cloud

mySewnet cloud is a service where you save and access your personal files, projects, stitches and designs, over the Internet instead of on your computer's hard drive. It is available to all owners and users of a mySewnet cloud enabled machine. The mySewnet cloud offers a simple way to manage and access personal files from different devices:

- mySewnet enabled machine.
- PC or MAC
- Smartphone or tablet.

App

The mySewnet app is available for free download on your mobile device. Visit our website to find and read more details, and download it directly from the App Store or Google Play.

mySewnet Website

The mysewnet.com website is the entrance to all the web services that are available when you have a mySewnet account.

When logged in, you can access everything included with your subscription and cloud, see your purchases, edit your account and more.

mySewnet Library

mySewnet library is a subscription service where you can get access to thousands of embroidery designs. You can also purchase and download single designs. Visit our website to read more about this service and start your subscription.

Connect to mySewnet on Your Machine

When you have established a WiFi connection, touch the exit icon to return to the mySewnet login page where you can sign in. If you do not have a user name and password, select Create Free Account.

An account can also be created through the mySewnet website at www.mysewnet.com.

When signed in you will see how much available space there is left in the mySewnet cloud.

The synchronization status will be shown on the mySewnet button on the topbar.

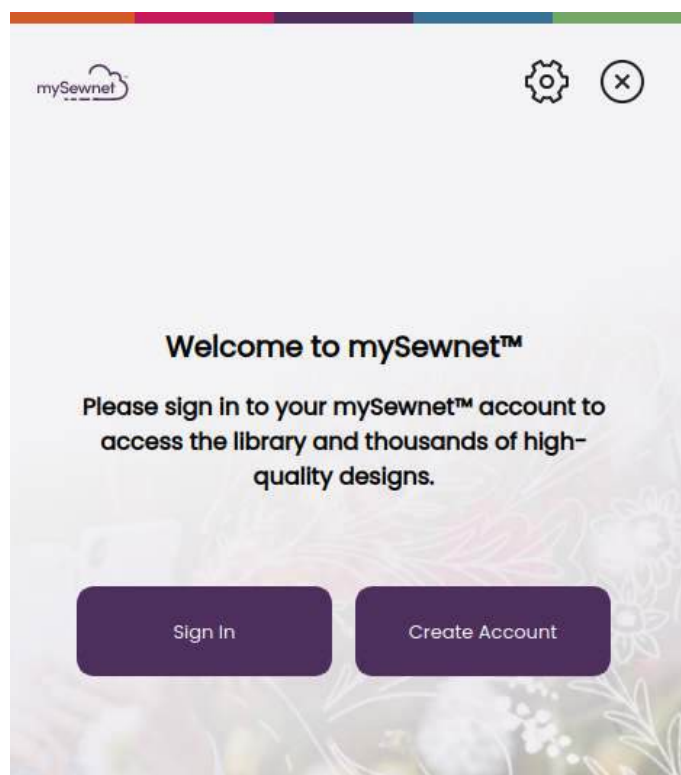

Used Space in mySewnet Cloud

The mySewnet cloud will store designs, fonts, stitches and other files from your machine.

Touch the mySewnet button on the topbar and go to mySewnet cloud, touch the cloud icon to see how much storage is available. When only a small amount of space is left, your machine will alert you once. If you continue to fill the space, it will not remind you again, until the space is completely full. Delete or move files to a USB device to free space.

Note: The mySewnet cloud space gets activated the first time you sign in on your mySewnet account from the machine.

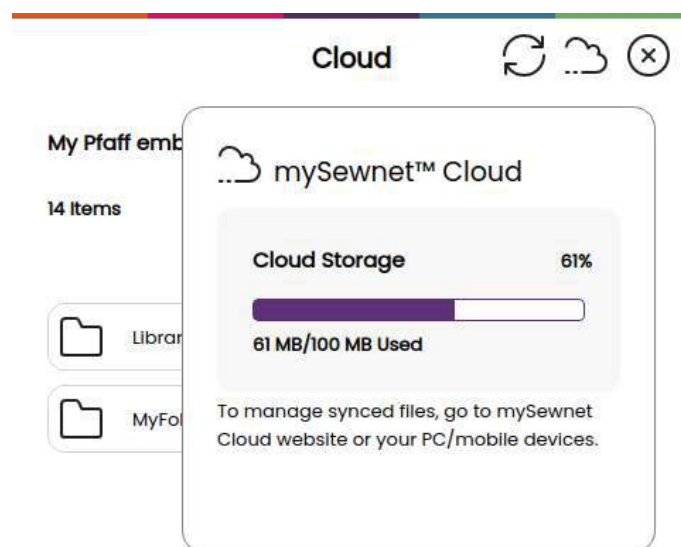

mySewnet Library on Your Machine

If you have a subscription, WiFi is connected and you have logged in to your mySewnet account, the mySewnet library menu will be visible in your machine. Here you can scroll and select from all your mySewnet library designs.

SEWING

Sewing Mode – Overview

In sewing mode you can select stitches, adjust and sew them. Your selected stitch will be shown in actual size in the stitch field.

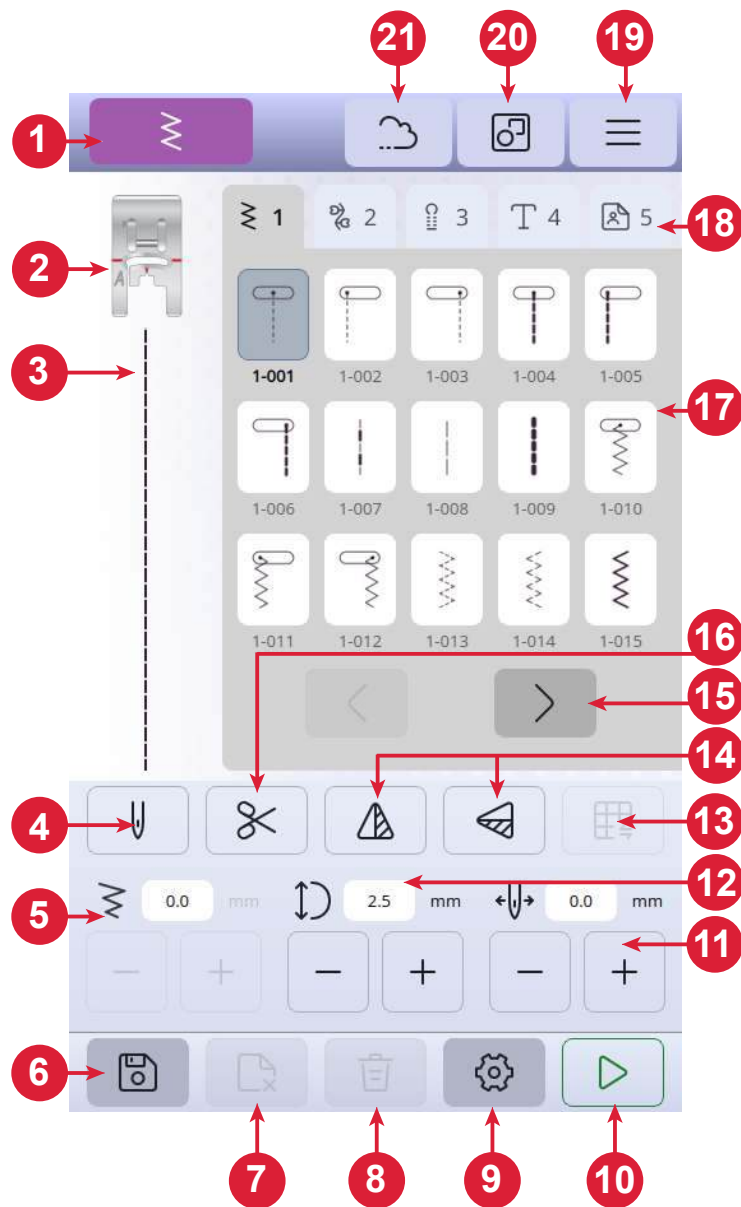

- | | | |
|--------------------------------|--|----------------------|
| 1. Sewing mode indicator | 10. Start / Stop | 18. Stitch menus |
| 2. Presser foot recommendation | 11. Needle position / Stitch positioning | 19. Machine settings |
| 3. Selected stitch | 12. Stitch length | 20. Multi-select |
| 4. Single or twin needle | 13. Balance stitch | 21. mySewnet |
| 5. Stitch width | 14. Mirror end to end / side to side | |
| 6. Save stitch sequence | 15. Step through / between stitch menus | |
| 7. Delete file | 16. Thread cutter | |
| 8. Delete stitch | 17. Stitches | |
| 9. Sewing settings | | |

What is a Stitch?

A stitch either consists of a single stitch as in a straight stitch, or as two individual stitches, e.g., in a zigzag. Furthermore, a stitch is also the complete stitch, meaning it is made up by the total of the individual stitches in the stitch, such as a 3 step zigzag or a decorative stitch.

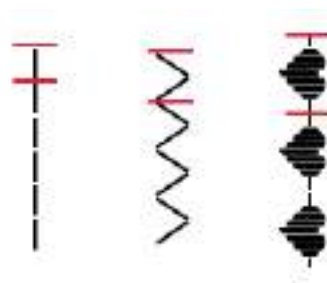

Select a Stitch or Letter

To load a stitch touch a stitch to select it from the stitch menu. The stitch will automatically be loaded and recommendations about what presser foot to use will be shown. Touch the left/right arrows to toggle between the different stitches. Touch the different stitch menu to select a different category.

Your machine has four stitch menus. Menu 1 includes Utility Stitches. Menu 2 has the Decorative Stitches. Menu 3 has the Buttonhole Stitches. Menu 4 includes the Alpha-Numeric characters. Menu 5 is for your saved stitch sequences that you create by combining different stitches.

Create a Sequence

To create stitch sequence:

1. Touch the Multi-select button.
2. Touch the different stitches to create a sequence.
3. Touch the Confirm button. The machine will stitch the sequence that was saved and will stop when the sequence is completed.

In order to repeat the sequence, press the Foot Control or the Start/Stop button.

Touch the Save button to save your sequence. Delete your stitch by touching the Delete Stitch button.

In your Personal Menu (5) you can delete files by touching the Delete Files button.

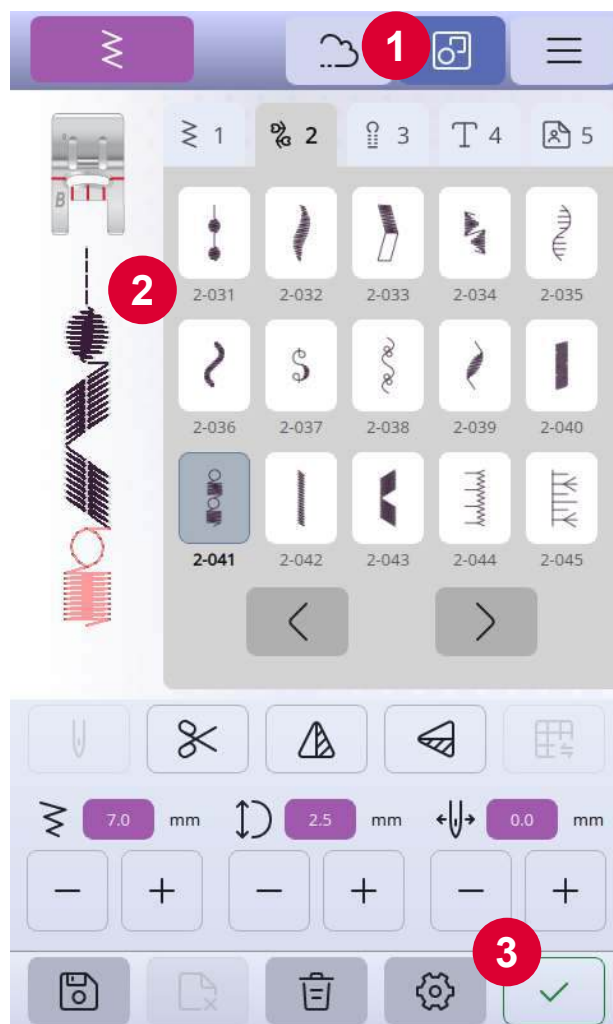

Fabric Guide

Different fabrics for each group, suitable for your projects, are listed below.

Note: Some fabrics have excess dye which can cause discoloration on other fabrics or on your embroidery machine. This discoloration may be very difficult or impossible to remove.

Fleece and denim fabric, especially red and blue, often contain excess dye.

Note: If you suspect that your fabric/ready-to-wear garment contains a lot of excess dye, always pre-wash it before embroidering to prevent discoloration of your machine.

Woven or Knit

The difference between woven and knit fabric is the way the threads are put together. Woven fabrics are made of two thread system, warp lengthwise and weft crosswise, that intersect at right angles. A knit fabric is made of one thread system with interlaced stitches. A knit fabric usually has stretch.

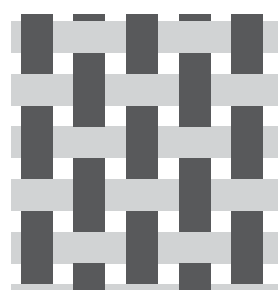

Woven fabric

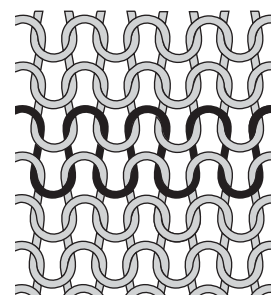

Knit fabric

Woven Fabrics

Woven Light: Chiffon, organza, batiste, challis, crepe de chine, etc.

Woven Medium: Calico, quilting fabrics, crepe, broadcloth, velvet, etc.

Woven Heavy: Denim, tweed, canvas, terrycloth etc.

Stretch Fabrics

Stretch Light: Tricot, single knit jerseys, etc.

Stretch Medium: Sweater knits, double knit, velour, swimwear, etc.

Stretch Heavy: Sweater knits, fleece, etc.

Stitch Settings

Your machine will set the recommended settings for each selected stitch. You can make your own adjustments to the selected stitch. The changes will only affect the selected stitch and will be reset to default when selecting another stitch or turning your machine off.

The controls available on the screen will change depending on what stitch is loaded. Some stitches have more than one control.

Note: The default setting is always shown in black numbers.

Stitch Width

Increase or decrease the stitch width using + and - in the control. The number above the control shows stitch width in millimeters (mm).

Changed stitch position may limit the stitch width adjustments.



Stitch Length

Increase or decrease the stitch length using + and - in the control. The number above the control shows the set stitch length in mm/inch. If lengthening a zigzag stitch or a decorative stitch, the entire stitch will be stretched out.

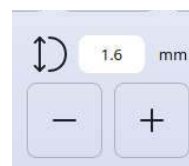

Needle Position / Stitch Positioning

On certain stitches with a width less than 7mm it is possible to change the stitch position. Use + to move the stitch to the right and - to move the stitch to the left. The number above the control shows the needle start position in mm/inch in relation to center needle position. The machine has a maximum of 29 needle positions (for a straight stitch).

The stitch position can only be changed to the limit of the maximum stitch width. Changing the stitch positioning will also limit the stitch width adjustments.

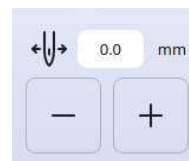

Tie-Off

The tie-off function is used to secure a stitch. Tie-offs consist of four stitches performed at the same spot. To activate or deactivate the tie-off function, simply touch the button in the settings menu. When you begin sewing with the tie-off function enabled, the machine will sew a few tie-off stitches before continuing with the selected stitch. However, if the machine has stopped before the Cut button is pressed, no tie-off stitches will be performed before cutting.

Once a cut has been made, the machine will automatically start with tie-off stitches the next time you begin sewing.

Note: The tie-off function can be selected for all stitches except buttonholes

Mirroring

To mirror a stitch or stitch program lengthwise, touch the mirror end to end button. To mirror a stitch or stitch program sideways, touch the Mirror Side to Side button.

Note: Some stitches e.g. buttonholes cannot be mirrored.



Side to side



End to end

Balance Stitch

If you are experiencing uneven stitch results when sewing, it may be necessary to adjust the balance. This is particularly important when working with special fabrics or techniques. To adjust the Balance of the active stitch, simply touch the balance button while in sewing mode. The balance adjustment is only available for a selected number of stitches.

Start by sewing the stitch on a piece of scrap fabric. Change the preview on the screen to match your sewn sample by using the + and - in the controls. When you sew again, the balance will be corrected.



Balance button in sewing mode

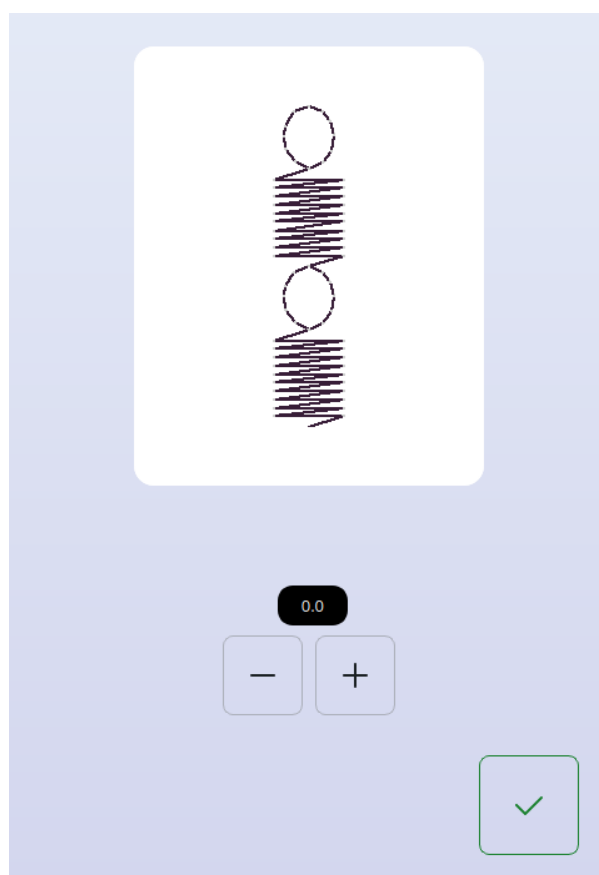

Pop-up window for balance

Free-Motion

For free-motion sewing lower the feed teeth on the back of the free arm. Attach the Embroidery/Free-Motion Foot. Move the fabric manually. Maintain a consistent speed and move the fabric in a smooth motion. You are creating the length of the stitch as you move the fabric.

Note: When the feed teeth are dropped, the fabric is no longer fed by the machine. You must move the fabric.

Basic Sewing Techniques

Seam

A seam sews two pieces of fabric together with a seam allowance that will usually be pressed open. In most cases, edges of the seam allowance are finished with an overcast stitch before sewing the seam.

Seams in stretch fabric must stretch with the fabric. The stretch stitch makes a stretchy seam that is suitable for sewing together pieces of light stretch fabric.

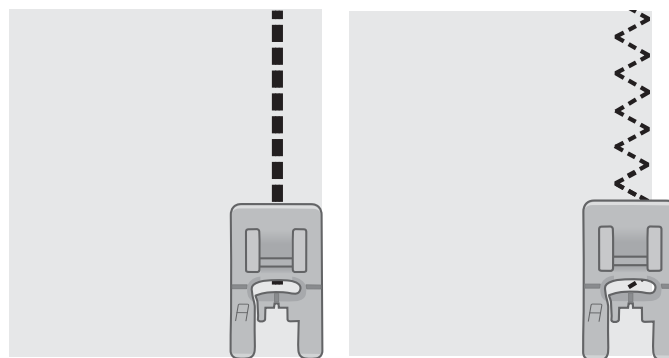

Straight Stitch

Stretch Stitch

Start to Sew – Straight Stitch

Raise the presser foot and position the fabric under it, next to a seam allowance guide line on the needle plate. On the bobbin cover there is a 1/4" (6mm) guide line.

Place the top thread underneath the presser foot.

Lower the needle to the point where you want to start. Bring the threads toward the back and lower the presser foot. Press the foot control. Gently guide the fabric along the seam guide letting the machine feed the fabric (A). If the bobbin thread isn't pulled up, it will be automatically as you start to sew.

To secure the beginning of a seam, press and hold the reverse lever. Sew a few reverse stitches. Release the reverse lever and the machine will sew forward again (B).

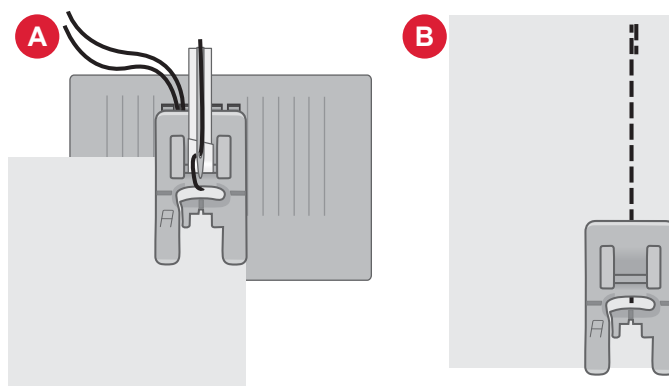

Change Needle Position

Some sewing is done more easily by changing the needle position, e.g., topstitching a collar or sewing in a zipper. The needle position is adjusted with the Needle Position button.

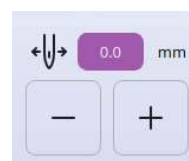

Needle Position

Change Sewing Direction

To change sewing direction, stop the machine. Press the Needle Stop button to activate the Needle Up / Down position button. The needle is brought down into the fabric.

Raise the presser foot.

Pivot the fabric around the needle to change sewing direction as desired. Lower the presser foot and continue sewing in the new direction.



Needle Up / Down Button

Finish Sewing

Press and hold the Reverse button and sew a few stitches in reverse when you reach the end of the seam. This will secure the seam so the stitches don't unravel.

Turn the handwheel toward you to raise the needle to its highest position. Raise the presser foot and remove the fabric, pulling the threads to the back.

Pull the threads up and into the Thread Cutter so that the threads are cut the proper length and your needle won't come unthreaded when you start the next seam.

Note: Your machine can only sew straight stitch and zigzag stitch - 1-001 to 1-003, 1-008, and 1-010 to 1-012 in reverse.



Reverse Button

Seam and Overcast

The seam/overcast stitch sews the seam and overcasts the edges all at one time. The seam/overcast technique is perfect for stitching ribbed neckbands and cuffs. There are a number of different seam/overcast stitches in your machine. Overcast fabric edges to prevent fraying and to help them lay flat. It is easier to overcast before the garment is sewn together.

Blind Hems

The blind hem creates an invisible hem on garments. There are two types of blind hem; one is recommended for medium to heavy woven fabric (1), the other for medium to heavy stretch fabric (2). The blind hem is not suggested for light weight fabric, leather and vinyl.



Woven fabric (1)



Stretch fabric (2)

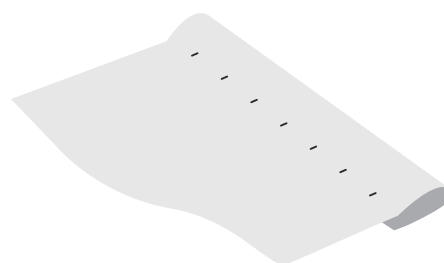

Right side of fabric

Darning and Mending

Repair Large Holes

To cover large holes it is necessary to sew a new piece of fabric onto the damaged area.

Baste the new piece of fabric onto the damaged area on the right side of the fabric.

Sew over the fabric edges with the zigzag or the multi-step zigzag stitch.

Trim the damaged area close to the seam from the wrong side of the fabric.

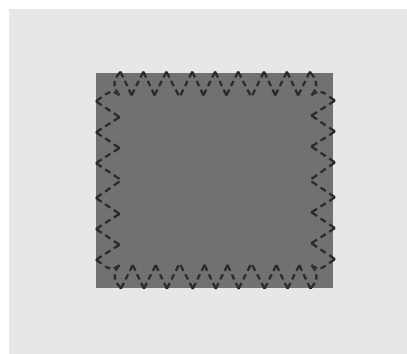

Repair Tears

On tears, frayed edges or small holes it is useful to lay a piece of fabric on the wrong side of the fabric. The underlaid fabric reinforces the damaged area.

Lay a piece of fabric underneath the damaged fabric. It must be a little larger than the damaged area.

Sew over the damaged area using the zigzag or multi-step zigzag stitch.

Trim the piece of fabric used as reinforcement.

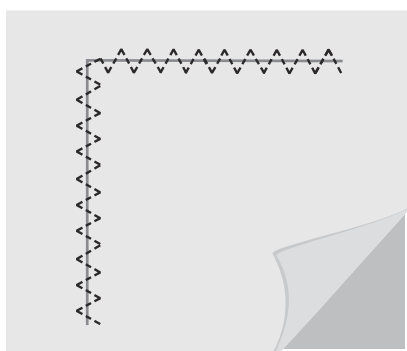

One-Step Buttonhole

Sew buttonholes perfectly sized for your button. The fabric should be interfaced and/or stabilized where buttonholes are to be sewn.

1. Mark the start position of the buttonhole on the fabric (A).
2. On the One-Step Buttonhole Foot, push the button holder open by pushing the lever backwards (B). Insert the button. Push the button holder forward until the button is locked in place (C). The button will determine the length of the buttonhole. The distance between the button holder lever (B) and the stopper (D) is the length of the buttonhole.
3. Attach the One-Step Buttonhole Foot.
4. Position your fabric under the presser foot so that the marking on the fabric is aligned with the red markings on the sides of the Buttonhole Foot (E).
5. Lower the Buttonhole Lever (F) all the way down. The Buttonhole Lever should fit between the button holder lever (B) and the stopper (D).
6. Hold the end of the upper thread and start sewing. The buttonhole is sewn from the front of the presser foot to the back. Stop sewing when the buttonhole is finished.
7. Once the buttonhole is finished, raise the presser foot. Push the Buttonhole Lever all the way up.
8. Use a seam ripper cut the buttonhole open from both ends towards the middle (G).

If you want to sew another buttonhole, do not push the Buttonhole Lever up when the buttonhole is finished. Sew another buttonhole.

Note: Always sew a test buttonhole on a piece of scrap fabric.

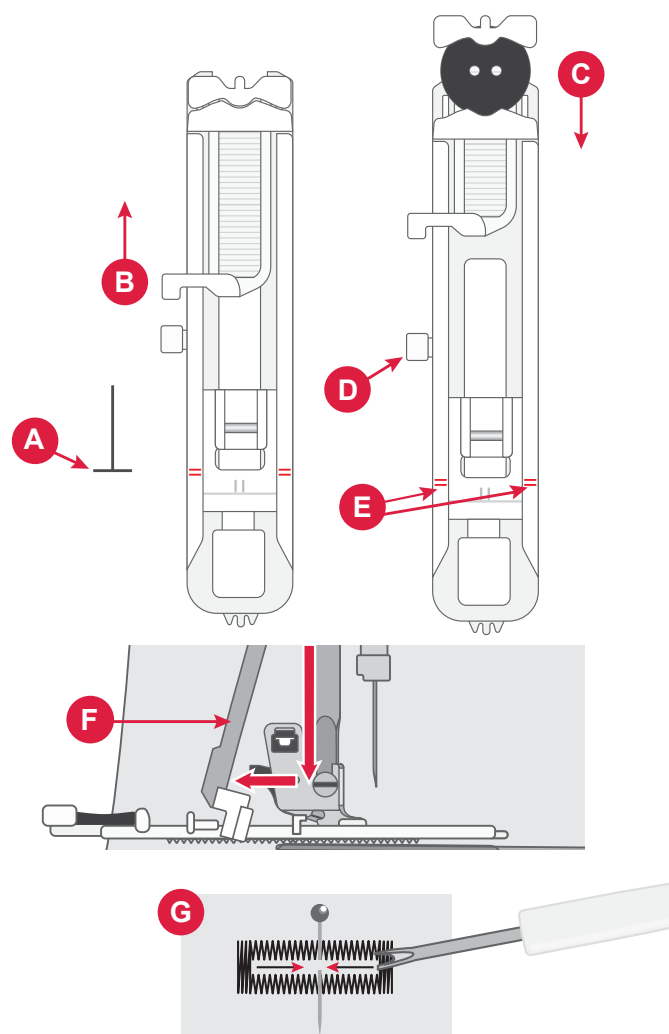

Sew Zippers

The Zipper Foot can be attached on either the right or the left of the needle, making it easy to sew both sides of the zipper.

To sew the right side of the zipper, attach the foot in the left presser foot position.

To sew the left side of zipper, attach the foot in the right presser foot position.

Centered Zipper

1. Place the fabric pieces right sides together and pin. Mark the zipper length on your fabric.
2. Baste the zipper seam using the specified seam allowance (use straight stitch with stitch length 4mm, thread tension 2). Baste to the end of zipper marking (C).
3. Set up the machine for straight stitch, backstitch a few stitches and sew the rest of the seam using the specified seam allowance (C).
4. Press the seam allowances open. Place the right side of the zipper to the wrong side of the seam, tape in place (D).
5. Flip your project, making sure that the right side is facing up. Snap on the Zipper Foot, to the left side of the needle (A).
6. Sew along the right side of the zipper to the end of your zipper, remember to backstitch in the beginning (E). Stop with the needle down in the fabric, lift the presser foot and turn your project to sew across the bottom of the zipper.
7. Attach the Zipper Foot to the right side of the needle (B). Sew the remaining zipper side as you did with the first side (F).
8. Flip your project to remove the tape on the back side.
9. Flip your project to the right side again and remove the basting stitches.

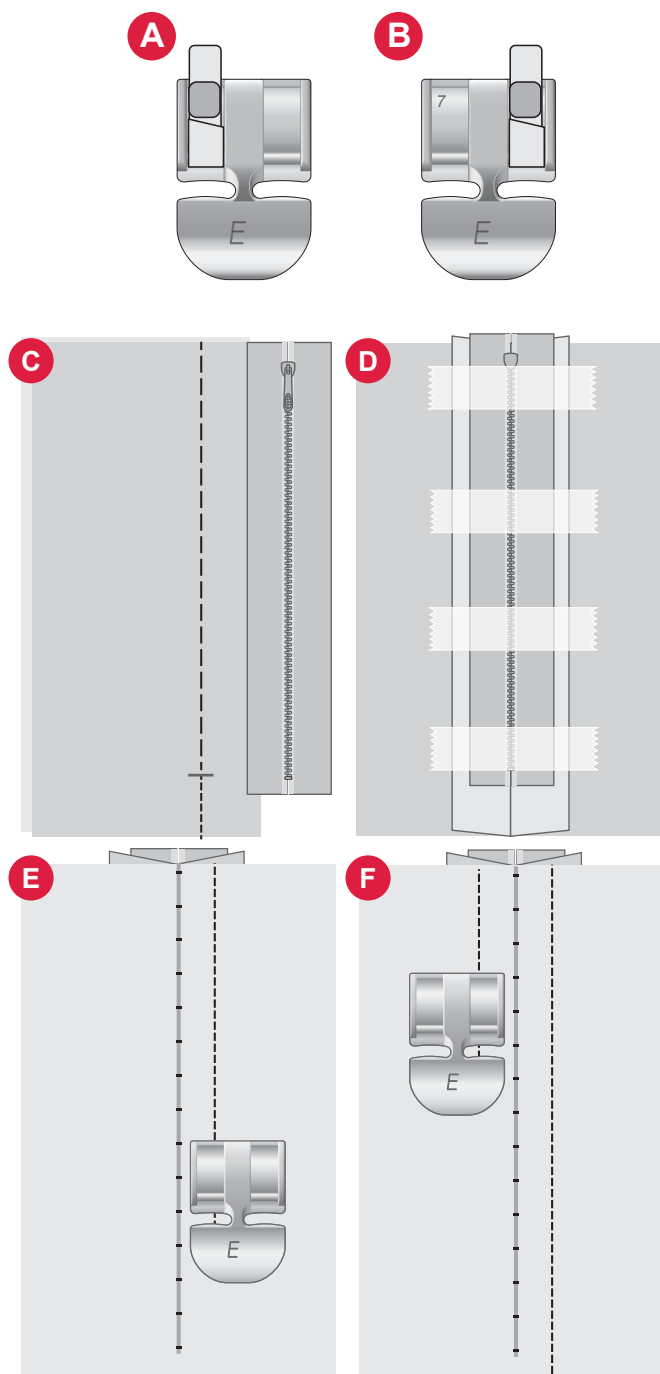

Sewing Pop-up Messages

Bobbin Thread Low

When the bobbin thread is running low, a pop-up message appears giving you notice that you will soon need to change the bobbin. This gives you an opportunity to plan when you want to change your bobbin.

Check Upper Thread

The machine stops automatically if the upper thread runs out or breaks. Re-thread the upper thread, close the pop-up message and start sewing.

Attention!

If the machine stops and this pop-up appears on the screen you need to stop sewing. Wait a moment and touch the OK button when it is enabled. Check the needle size and condition. Check for correct threading.

EMBROIDERY

Getting Started to Embroider

To enter embroidery mode, slide on the embroidery unit. Make sure that the area is clear so that the embroidery unit can calibrate when needed.

Note: You can not access the sewing mode while having the embroidery unit on.

Embroidery Mode— Overview

In embroidery mode you can select designs and fonts, manage your saved files and access the mySewnet library.

1. Design menu
2. Font menu
3. File manager
4. Delete / remove design
5. Multi Select
6. mySewnet
7. Embroidery edit



Load a Design

Touch a design to load it in the embroidery mode. To edit the selected design, touch the embroidery edit icon.

Touch the left and right button in the selection area to browse through the built in designs. When a design is selected, information about the design will be shown in the top bar. Please note that in order to load more than one design, you must have the 'Multi-select' option selected

Note: You can also load saved designs from the mySewnet cloud folder and from a USB device in file manager.

Create Embroidery Text

To create a text, open the font menu and touch your desired font on the screen. You can change the font and size of the text as desired. Once you've written your text, touch the confirm button to load it into text edit mode. Read about the various text edit options below to learn more.

Mirror text (1)

To mirror your text sideways, touch the Mirror Side to Side button.

Rotate text (2)

Use the different Rotation buttons to adjust the rotation of the selected design(s) in one degree increments. Each touch in the center of the control wheel will rotate the selected text(s) 90 degrees clockwise.

Text Spacing (3)

The distance between each letter can be increased or decreased with the spacing option.

Text Shaping (4)

You can edit your written text using two different shaping options. To do so, select a shaping option and your text will follow the shape on the screen.

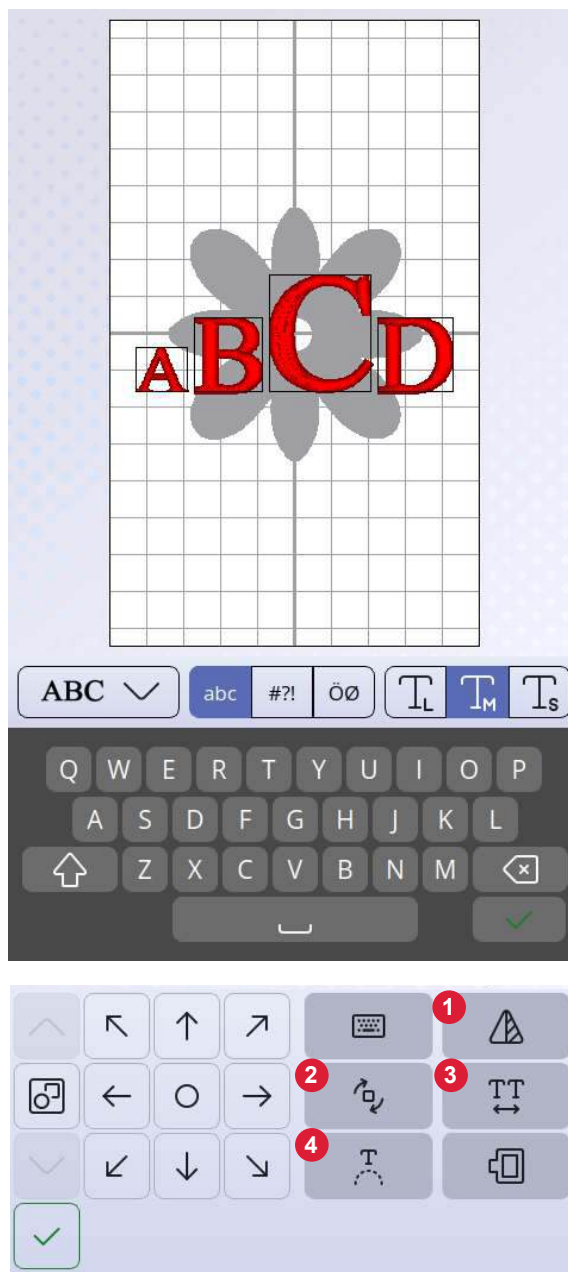

To Create Text:

1. Select the Font Menu and touch a font to select it.
2. Touch the different letters to create a sequence.
3. Touch the Confirm button. The machine will stitch the letter sequence that was saved and will stop when the sequence is completed.

In order to repeat the sequence, press the Foot Control or the Start/Stop Button.

Save your sequence by touching the Save button.

File Manager

To view, open, or delete your designs saved in the machine's built-in memory, touch the File Manager.

Delete

When you touch Delete, the selected design(s) will be deleted from the embroidery area. If more than one design is selected, a pop-up message will appear.



Embroidery Edit – Overview

In embroidery edit you can adjust, combine, save and delete designs and fonts. The loaded design(s) are shown in the embroidery area.

1. Embroidery area
2. Rotate options
3. Scale options
4. Thread color edit / Background color
5. Mirror side to side
6. Delete design
7. Save design
8. Go to embroidery stitch out
9. Hoop selection
10. Control wheel
11. Arrange
12. Design information
13. Total number of stitches in design combination

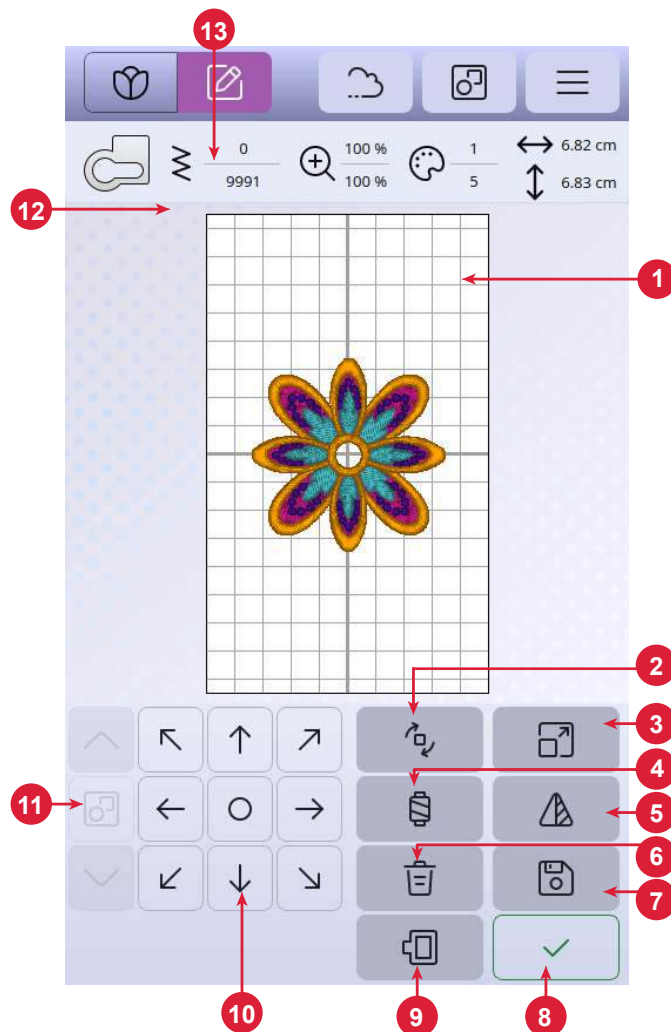

Total Number of Stitches in Design Combination

You can see the total stitches in your design combination next to the presser foot recommendation in Embroidery Edit.

Control Wheel

Touch and move a selected design with your finger to position it anywhere in the embroidery area.

Use the wheel to adjust the position of the selected design(s).

Touch the center of the control wheel to position the selected design(s) in the center of the hoop.

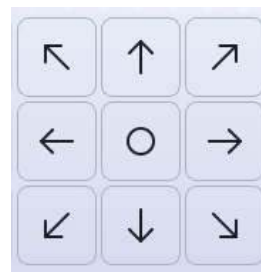

Rotate

Touch the different Rotation buttons to rotate the selected design(s). You can rotate your design 90°, 10° and 1 degree.

When rotating, the selected design(s) will be rotated around the center point of the selected design(s).



Thread Color Edit / Background Color

Touch the Thread Color Edit / Background Color to view a list of thread colors in the selected design(s) and change the background color for the hoop.



Thread color edit

You can edit the colors in your design. Touch the color block in the list that you want to change. Touch it again to select a new thread color. The previous used color will be displayed under the new color.

Background color

Select a background color for the embroidery area that matches the color of the fabric you will use. Choose between different background colors. The selected background color will be shown in the hoop and the previous used color will be displayed under the new color. Touch the arrows to toggle between the different designs.



Arrows to toggle between the different designs

Delete

When you touch Delete, the selected design(s) will be deleted from the embroidery area.



Hoop Selection

To select a hoop size, touch the Hoop Selection button. A list will appear with hoop choices.

After selecting your hoop size, the list will close automatically.



Scale

With the touch function, scale, you can increase or decrease the size of the selected design(s) without changing the number of stitches.

Use the Scale Buttons to adjust the size of the selected design (s). Touch the Undo button to scale the design to the default size. The toolbar above embroidery area shows, in millimeters, the current width and height.



Mirror Side to Side

To mirror a design horizontally, touch the Mirror Side to Side button.



Too Small Hoop

A red frame will surround the embroidery area if a design is too big for the selected hoop.

Embroidery Stitch Out

To proceed to embroidery stitch out, touch the Confirm button in the embroidery edit overview.



Multi-Select

Touch the Multi-select button to add more designs to the embroidery after choosing your desired designs, touch the embroidery edit button to do any changes.

If you have selected two or more designs and want to combine them to be adjusted as one design, touch the Group/Ungroup button. A design selection frame will surround each design that is selected and, when grouped, the design selection frame will surround all of the designs in the group. To ungroup, touch the Group/Ungroup button again and they will once again become individual designs.



Group



Ungroup

Save Design

To save your file, touch the Save button. Your design will then be saved to your “file manager” found in the Embroidery Overview.

You can choose to save the file to the mySewnet cloud folder or to a USB device. Previously saved designs are shown.

Touch the mySewnet icon at the top of the screen and then touch the Save to Cloud, choose the folder, then name your file and touch the Save button to confirm.

To cancel the save process, close the pop-up window by touching Cancel. The save pop-up will close and you will return to your previously used folder.

Note: You can only view your saved designs in Embroidery Mode.



Embroidery Edit Pop-up Messages

Too many designs selected. Please remove a design and try again.

This pop-up appears for one of the following reasons:

- The design combination contains too many color blocks.
- There are too many designs in the combination.
- The design combination you are trying to make contains too many stitches.

The Bobbin Thread Is Running Low

When the bobbin thread is running low, a pop-up message appears giving you notice that you will soon need to change the bobbin. This gives you an opportunity to plan when you want to change your bobbin.

Sound

When active, the signal for some warning alerts or attention pop-up messages will be repeated in intervals until the pop-up is closed.

Attention!

If the machine stops and this pop-up appears on the screen you need to stop sewing. Wait a moment and touch the confirm button when it is enabled. Check the needle size and condition. Check for correct threading.

Save Design to the mySewnet Cloud

You can choose to save the file to the mySewnet cloud folder or to a USB device. Previously saved designs are shown.

Touch the mySewnet tab at the top of the screen, then touch the Save to Cloud, choose the folder, then name your file and touch the Save button to confirm.

To cancel the save process, close the pop-up window by touching Cancel. The save pop-up will close and you will return to your previously used folder.

Note: You can only view your saved designs in the embroidery mode.

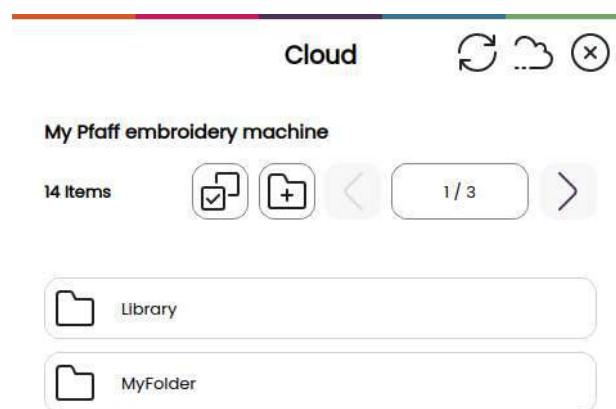

Send Design

Touch the mySewnet tab at the top of the screen. Send selected embroidery designs directly to other mySewnet enabled devices. Choose any of the available devices by touching it. The pop-up closes and the selected design(s) are sent.

Note: You can only send designs to devices connected to the same mySewnet cloud account.

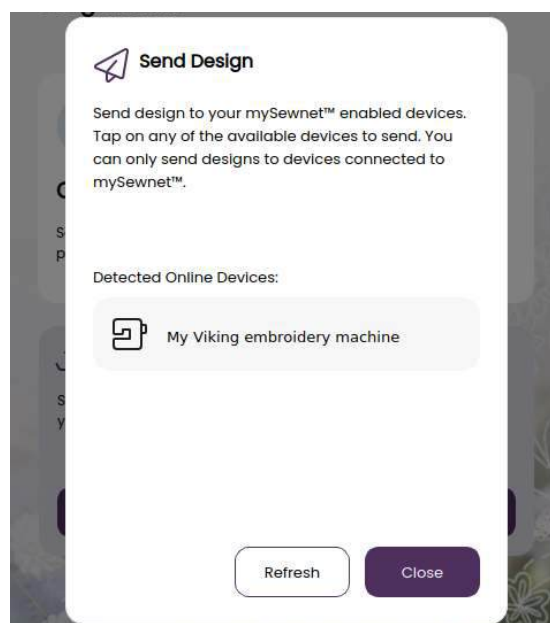

mySewnet Library

mySewnet library is a service where you can get access to thousands of embroidery designs. Visit our website to read more about this service and start your subscription.

If you have a subscription, WiFi is connected and you have logged in to your mySewnet account, the mySewnet library will be visible in your machine. Here you can scroll and select from all your mySewnet library designs. To access the mySewnet library, simply just touch the mySewnet library icon available in the mySewnet tab.

Use the search function to find different types of designs. There are several ways to filter and sort designs. Filter designs by size by changing the maximum width and/or maximum height. Designs you've marked as favorite designs in mySewnet can also be filtered in your machine if you touch the Favorite Designs button.

You can also sort the designs by color block count, size (area) or stitch count. Touch the Sort From button to sort from highest to lowest value. Touch the Sort To button again to sort from lowest to highest value instead.

To remove all applied filters and clear your search, touch clear filter.

If you haven't started a subscription yet, the mySewnet library menu will still be visible in your machine, but no designs in this menu will be shown.

1. Search
2. Filter
3. Sort
4. Toggle between different designs



EMBROIDERY STITCH-OUT

To proceed to Embroidery Stitch Out, touch the Confirm button in the Embroidery Edit overview.

Embroidery Thread Tension

For optimal embroidery results, set the thread tension to a range of 1-2. Adjust as needed to achieve the best outcome for your specific project.

Embroidery Stitch-Out – Overview

1. Embroidery Area
2. Thread Color Information
3. Start / Pause Embroidery Stitch-Out
4. Return To Embroidery Edit
5. Design Placement
6. Thread Cut
7. Step Stitch-by-Stitch/Go to Stitch
8. Embroidery Settings
9. Lock Screen
10. Number of Stitches in Current Color Block

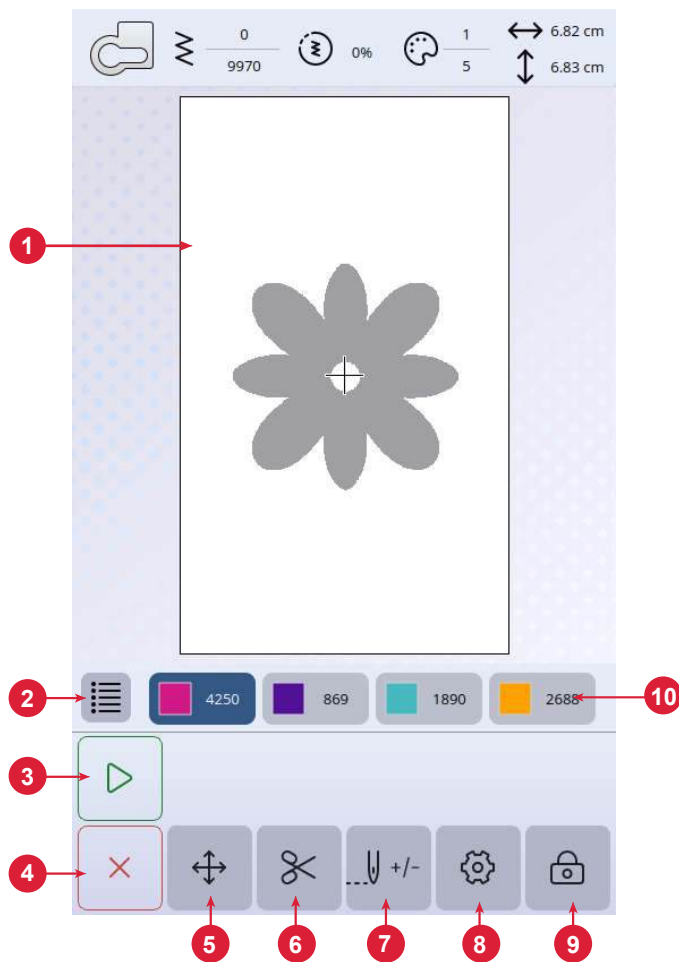

Start/Pause

Touch the Start/Pause icons to start and stop the machine sewing or embroidering without using the foot control or the button.



Thread Cut

Touch the Thread Cut and the machine cuts the upper and bobbin threads.



Thread Color Blocks

All colors in the loaded design(s) are shown in the order they will be embroidered with thread color blocks.

Touch the Color List to view a full list of all colors used in the design. Touch the arrows in the color list to see all of the color blocks.

Open the Go to Stitch / Color Change to activate the next or previous color block in the color block list by touching a different color block.

Thread Color Information

1		2261		4250/4250	
2		2430		869/869	
3		2204		1890/1890	
4		2465		854/2688	
5		2465		0/269	



Number of Stitches in Current Color Block

The current stitch position in the current color block is shown next to the stitch icon. The numbers on the right shows the total number of stitches in the current color block.

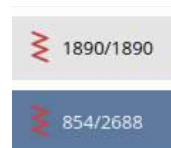

Return To Embroidery Edit

Touch this icon to return to Embroidery Edit if you want to make adjustments to your design(s). A pop-up message will appear asking if you want to return to Embroidery Edit because any changes made in Embroidery Stitch-Out will be lost.



Step Stitch-by-Stitch/Go to Stitch

Touch + to step forward and - to step backwards stitch by stitch. Move backwards a few stitches, e.g., after the upper thread breaks or runs out, to ensure that the thread will be secured. Touch & hold to move through the stitches more rapidly. The cursor on the screen will follow the stitches in the embroidery area.



To go to a particular stitch within the color block, touch the go to stitch button and enter the stitch number. If the number entered is too large, the machine will move to the last stitch in the current color block.

Exact Positioning

Use the design placement feature to place a design on an exact location on your fabric without re-hooping. It can also be useful when you want to embroider a design to exactly match a specific spot on your project or next to a previously embroidered design. Use the corner icons to place the design in a corner of the hoop. Use the different arrows to freely place your design.

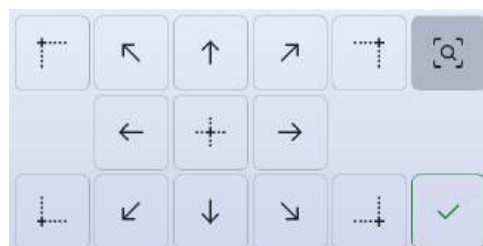
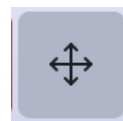

Corner Check

Use Corner Check to trace the four corners of the design to see where the design will be stitched out on the fabric.

Each touch on the Corner Check button will move the hoop to the following positions and in the following order: upper left, upper right, lower right, lower left and then go back to the current stitch position.



Embroidery Stitch Out Pop-up Messages

The Embroidery Arm Needs to Calibrate

When the embroidery unit is attached, a pop-up message will appear and inform you to slide off the hoop and clear the machine area for calibrating the embroidery arm. You will also be reminded to attach a suitable embroidery foot.

Your Embroidery is Finished

A pop-up message and sound informs you that your embroidery is finished. When the pop-up is closed the design will stay loaded in embroidery stitch out and you can stitch the same embroidery again, including any changes you have made.

MAINTENANCE

Cleaning the Machine

To keep your sewing machine operating well, clean it often. No lubrication (oiling) is needed. Wipe the exterior surface of your machine with a soft cloth to remove any dust or lint built up.

Cleaning the Bobbin Area

 *Raise the needle and turn off the machine.*

Remove the presser foot. Slide off the bobbin cover and remove the bobbin.

Remove the plastic part of the needle plate by sliding it off.

Remove the screws in the needle plate by using the Multi-purpose tool. Lift up and remove the needle plate.

Clean the feed teeth and the bobbin area with the brush found among the accessories.

Place the needle plate over the feed teeth, replace and tighten the screws.

Attach the presser foot, insert the bobbin and replace the bobbin cover.

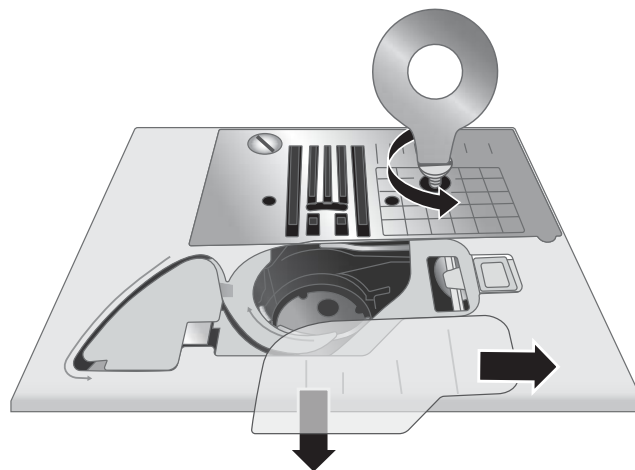

Cleaning under the Bobbin Area

 *Raise the needle and turn off the machine.*

Clean the area under the bobbin case after sewing several projects or any time you notice an accumulation of lint in the bobbin case area.

Remove the presser foot. Slide off the bobbin cover and remove the bobbin.

Remove the plastic part of the needle plate by sliding it off.

Remove the screws in the needle plate by using the Multi-purpose tool. Lift up and remove the needle plate.

Remove the bobbin case by lifting it up. This is easier if you push it slightly to the left or right as you lift.

Clean the area with the brush or with a dry cloth.

Note: Do not blow air into the bobbin case area. The dust and lint will be blown into your machine.

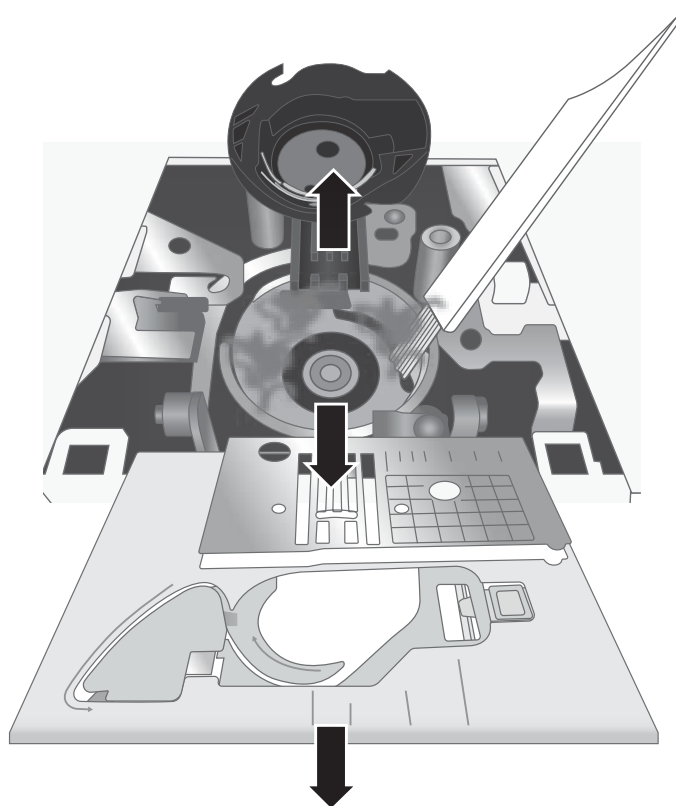

Troubleshooting

Thread Loops on Underside of Fabric

Possible cause: Thread looping on the underside of the fabric is always an indication that the upper thread is not correctly threaded. This happens when the upper thread is not correctly placed in the thread tension mechanism and has not been threaded through the take up lever.

Solution: *Rethread the machine, making sure to first raise the presser foot lifter before starting to thread, so thread can be properly seated in the tension mechanism and take up lever. To know if you have rethreaded the machine correctly, try this test:*

- Raise the presser foot lifter and thread the top of the machine.
- Thread the needle, but don't put the thread under the presser foot yet. As you pull the upper thread to the left, it should pull freely.
- Put the presser foot lifter down. As you pull the upper thread to the left, you should feel resistance. This means you are threaded correctly.
- Put the thread under the presser foot, and then draw up the bobbin thread. Slip both thread tails under the presser foot towards the back. Lower the presser foot and begin sewing.

If you put the presser foot lifter down, but the thread still pulls freely (you feel no difference whether the presser foot is up or down), this means that you have threaded incorrectly. Remove the upper thread and rethread the machine.

Bobbin Thread Breaking

Possible cause: Bobbin threaded incorrectly.

Solution: *Check that bobbin is placed correctly in the bobbin holder.*

Possible cause: Bobbin wound too full or unevenly.

Solution: *Bobbin thread may not have been correctly placed into bobbin winding tension disc during the bobbin winding process.*

Possible cause: Dirt or lint in bobbin holder.

Solution: *Clean bobbin holder.*

Possible cause: Wrong bobbins being used.

Solution: *Use bobbins that are the same style as those that come with the machine (HUSQVARNA® VIKING® VIKING® Class 15 transparent bobbins) – don't substitute.*

Bobbin Thread Showing on Top of Fabric

Possible cause: Top thread too tight.

Solution: *Reduce upper thread tension.*

Possible cause: Thread path is obstructed, putting extra tension on top thread.

Solution: *Check that the top thread path is not obstructed and thread is moving freely through the thread path.*

Possible cause: Bobbin thread not in bobbin case tension.

Solution: *Rethread bobbin.*

Bobbin Winding Difficulties

Possible cause: Bobbin thread loosely wound on bobbin.

Solution: *Rewind bobbin, making sure that the thread is placed snugly in the bobbin winding tension disc.*

Possible cause: Bobbin winding spindle not fully engaged, therefore bobbin not winding.

Solution: *Check that the bobbin winding spindle has been fully engaged before starting to wind.*

Possible cause: Bobbin is winding sloppily because thread end not held at beginning of winding process.

Solution: *Before starting to wind, hold the thread tail (coming out of the bobbin) securely, allow the bobbin to partially fill, then stop to trim the thread tail close to the bobbin.*

Fabric Puckers

Possible cause: Top thread is too tight.

Solution: *Reduce top thread tension.*

Possible cause: Stitch length is set too short.

Solution: *Increase stitch length setting.*

Possible cause: Wrong style needle for fabric type.

Solution: *Use correct needle style and size for your fabric.*

Fabric Is Tunneling Under Stitches

Possible cause: Fabric is not properly stabilized for the density of the stitches (for example, satin stitch applique).

Solution: *Add a fabric stabilizer underneath the fabric to help keep the stitches from tunneling in together, forming a puckered ridge in fabric.*

Loud Noise When Sewing

Possible cause: Thread not in take-up lever.

Solution: *Rethread the machine, making sure the take up lever is in its highest position so thread goes in the eye of the take up lever — turn machine hand wheel toward you to raise the take up lever to its highest position for threading.*

Possible cause: Thread path is obstructed.

Solution: *Check that thread is not caught on the thread spool or behind the spool cap.*

Machine is Not Feeding Fabric

Possible cause: Presser foot lifter has not been lowered onto fabric after threading.

Solution: *Lower the presser foot lifter before starting to sew. Don't "push" or "pull" the fabric as you sew.*

Possible cause: Feed teeth lever may have been returned to "up" position, but the handwheel has not yet been turned one full turn to completely re-engage the feed teeth.

Solution: *The feed teeth need to be raised and re-engaged by turning the handwheel one full revolution.*

Possible cause: Stitch length is set at zero.

Solution: *Increase stitch length setting.*

Machine Will Not Run

Possible cause: Bobbin winding spindle is engaged when you try to sew.

Solution: *Disengage bobbin winding spindle by pushing it to the left.*

Possible cause: Power cord and/or foot control not plugged in correctly.

Solution: *Make sure power cord/foot control are correctly seated in machine and power supply.*

Possible cause: Wrong bobbins being used.

Solution: *Use bobbins that are the same style as those that come with the machine (HUSQVARNA® VIKING® VIKING® Class 15 transparent bobbins)— don't substitute.*

Needles Breaking

Possible cause: Bent, dull or damaged needle.

Solution: *Discard needle, insert new needle.*

Possible cause: Wrong size needle for fabric.

Solution: *Insert appropriate needle for fabric type.*

Possible cause: Machine not threaded correctly.

Solution: *Rethread the machine completely.*

Possible cause: “Pushing” or “pulling” fabric.

Solution: *Don't manually push/pull fabric in order to sew, but allow the machine's feed teeth to draw fabric under the presser foot as you guide it.*

Needle Threader Not Working

Possible cause: Needle not in correct position.

Solution: *Raise needle to its highest position by turning hand wheel toward you.*

Possible cause: Needle is inserted incorrectly.

Solution: *Position needle all the way up in the needle clamp.*

Possible cause: Needle is bent.

Solution: *Remove the bent needle, insert new needle.*

Possible cause: Hook pin damaged.

Solution: *Needle Threader needs replacement. Contact authorized service center.*

Skipping Stitches

Possible cause: Needle inserted incorrectly.

Solution: *Check that flat side of needle top is toward back of machine and needle is up as far as it can go, then tighten needle clamp screw.*

Possible cause: Wrong needle for fabric sewn.

Solution: *Use correct needle style and size for your fabric.*

Possible cause: Bent, dull or damaged needle.

Solution: *Discard needle and insert new needle.*

Stitches Distorted

Possible cause: “Pushing” or “pulling” the fabric.

Solution: *Don't manually push/pull fabric in order to sew, but allow the machine's feed teeth to draw fabric under presser foot as you guide it.*

Possible cause: Incorrect stitch length setting.

Solution: *Adjust stitch length setting.*

Possible cause: Stabilizer may be needed for technique.

Solution: *Place stabilizer underneath fabric.*

Thread Bunching at Beginning

Possible cause: Top and bobbin threads have not been properly placed underneath presser foot before starting to sew.

Solution: *Ensure that both the top thread and the bobbin thread are under the presser foot and toward the back before starting to sew.*

Possible cause: Sewing was started with no fabric under the presser foot.

Solution: *Place fabric under foot, making sure that needle comes down into fabric; lightly hold both thread tails for first few stitches.*

Possible cause: Stabilizer may be needed for technique.

Solution: *Place stabilizer underneath fabric.*

Upper Thread Breaking

Possible cause: Thread path obstructed

Solution: *Check if thread is caught on thread spool (rough spots on the spool itself) or behind spool pin or spool cap (if the thread has fallen behind the spool cap and therefore cannot feed freely through the machine path).*

Possible cause: Machine is not threaded correctly.

Solution: *Remove upper thread completely, raise presser foot lifter, rethread machine making sure thread is in take-up lever (raise take up lever to its highest position by turning hand wheel toward you).*

Possible cause: Upper tension too tight.

Solution: *Reduce upper thread tension.*

General Problems

Possible cause: Thread cutter does not cut the thread.

Solution: *Remove needle plate and clean lint from bobbin area.
Enable automatic thread cutter in the settings menu.*

Possible cause: Poor sewing/embroidery result.

Solution: *Use only accessories designed for your machine.
Follow the on-screen recommendations*

Possible cause: The sewing and embroidery machine screen and/or function buttons do not respond to touch.

Solution: *The sockets and function buttons on the machine can be sensitive to static electricity. If the screen does not respond to touch, turn the machine OFF and then ON again. If the problem persists, contact your authorized HUSQVARNA® VIKING® VIKING® retailer.*

Embroidery Problems

Possible cause: The Embroidery Design Is Distorted

Solution:

- *The fabric must be tightly hooped.*
- *Hoop the fabric in such a way that the inner hoop exactly matches the outer hoop.*
- *Clear area around the embroidery unit.*
- *Make sure the hoop connector is inserted all the way into the hoop attachment on the embroidery arm.*

Possible cause: The Embroidery Design Has Puckered

Solution: *Ensure you use the proper stabilizer for your technique or fabric type.*

Possible cause: The Machine Will Not Embroider

- Solution:
- *Make sure that the embroidery unit is properly attached into the socket.*
 - *Slide on the correct hoop.*

The Machine Cannot Connect to a WiFi Network

Possible cause: Cannot Connect to WiFi.

- Solution:
- *Make sure that WiFi is enabled on your machine. Touch the WiFi button on the top bar or go to WiFi settings.*
 - *Make sure that the machine detects a signal from your WiFi network. If there is no signal, move the machine closer to the WiFi router.*
 - *Make sure you have selected your WiFi network.*

The Machine Cannot Synchronize with the mySewnet™ Cloud

Possible cause: The machine cannot synchronize files with the mySewnet™ cloud.

- Solution:
- *Make sure that you have a working WiFi connection. Make sure that you have signed in to your mySewnet™ account. New mySewnet™ accounts are registered in the machine or at mysewnet.com*
 - *Make sure that there is available space on the mySewnet™ cloud.*
 - *If the mySewnet™ cloud is not accessible although you have checked the WiFi connection, the server could temporarily be unavailable. Please try again later.*

Service

Have Your Sewing Machine Serviced Regularly by Your Local Authorized Retailer!

If you have followed this troubleshooting information and still have problems, contact your retailer. It may be helpful to bring the fabric, thread and stabilizer you are using with you. If you have a stitch out that shows the problem, please bring that as well. A sewing sample will often give better information than words and help your technician diagnose the problem.

Non-Original Parts and Accessories

The warranty does not cover any defect or damage caused by use of non-original accessories or parts.

Technical Specification

Household sewing machine

Sewing Speed Maximum 800 ± 50 rpm (using straight stitch with default stitch length)	Rated Voltage 240V/50Hz,230V/50Hz,220V/50Hz, 127V/50Hz,120V/50Hz,125V/50Hz	Presser Foot Rise Height 6-12mm
Protection Class II (Europe)	Stitch Width 0-7mm	Stitch Length 0-5mm
Type of Light LED light	Machine Dimensions Length: ≈607mm Width: ≈358mm Height: ≈308mm	Net weight Machine only: 9.5 kg Embroidery unit: 2.3 kg
WiFi Module Frequency: 2.4 band / 802.11 b/g/n Transmitting power: +17 dBm Receiver sensitivity: -97 dBm	Nominal Consumption <100W	Foot Control Model 33911.00025 manufactured by Shang Gong Group Co., Ltd. Jiangsu Household Sewing Machine Branch (China).

The technical specifications and this user's guide can be changed without prior notice.

You have purchased a modern, updatable sewing and embroidery machine. As we regularly release firmware updates, it is possible that there may be some differences between the machine firmware and the firmware described in the user's guide. Consult your local authorized HUSQVARNA® VIKING® VIKING® retailer, and be sure to visit our website at www.husqvarnaviking.com for the latest updates of the firmware and the user's guide.

We reserve the right to change the machine equipment and the assortment of accessories without prior notice, or make modifications to the performance or design. Such modifications, however, will always be to the benefit of the user and the product.

INTELLECTUAL PROPERTY

Patents protecting this product are listed on a label positioned underneath the Sewing Machine.

VIKING, MYSEWNET and KEEPING THE WORLD SEWING are exclusive trademarks of Singer Sourcing Limited LLC or its Affiliates.

HUSQVARNA and the "H" Crown Device are trademarks of Husqvarna AB and are used under license.

© 2024 Singer Sourcing Limited LLC or its Affiliates. All rights reserved.



Please note that on disposal, this product must be safely recycled in accordance with relevant National legislation relating to electrical/electronic products. Do not dispose of electrical appliances as unsorted municipal waste, use separate collection facilities. Contact your local government for information regarding the collection systems available. When replacing old appliances with new ones, the retailer may be legally obligated to take back your old appliance for disposal free of charge.

If electrical appliances are disposed of in landfills or dumps, hazardous substances can leak into the groundwater and get into the food chain, damaging your health and well-being.

IMPORTER TO THE UK:

VSM UK

Ravensbank House, Ravensbank Drive North Moons Moat,
Redditch. B98 9NA, United Kingdom

MANUFACTURER

VSM Group AB, **SVP WORLDWIDE**

Soldattorpsgatan 3, SE-55474 Jönköping, SWEDEN



www.husqvarnaviking.com