

User's Guide

Topaz™ | 55Q

IMPORTANT SAFETY INSTRUCTIONS

Read all instructions before using this sewing machine.

When using an electrical appliance, basic safety precautions should always be followed, including the following:

Keep the instructions at a suitable place close to the machine. Make sure to hand them over if the machine is given to a third party.

This appliance is intended for use by adults. The appliance can be used with adult supervision by (i) children aged from 8 to 12 years and (ii) persons with reduced physical, sensory or mental capabilities or lack of experience and knowledge if they have been given instruction concerning use of the appliance in a safe way and understand the hazards involved. Cleaning and user maintenance shall not be made by children without supervision. It is not allowed for anyone to play with the machine. Children up to 8 years are not allowed to use the machine.

DANGER - TO REDUCE THE RISK OF ELECTRIC SHOCK:

- A sewing machine should never be left unattended when plugged in. The electrical socket, to which the machine is plugged in should be easily accessible. Always unplug this sewing machine from the electric outlet immediately after using and before cleaning, removing covers, lubricating or when making any other user servicing adjustments mentioned in the instruction manual.

WARNING –TO REDUCE THE RISK OF BURNS, FIRE, ELECTRIC SHOCK, OR INJURY TO PERSON:

- Do not allow to be used as a toy. Close attention is necessary when this sewing machine is used by or near children.
- Use this sewing machine only for its intended use as described in this manual. Use only attachments recommended by the manufacturer as contained in this manual.
- Never operate this sewing machine if it has a damaged cord or plug, if it is not working properly, if it has been dropped or damaged, or dropped into water. Return the sewing machine to the nearest authorized dealer or service center for examination, repair, electrical or mechanical adjustment.
- Never operate the sewing machine with any air openings blocked. Keep ventilation openings of the sewing machine and foot control free from the accumulation of lint, dust, and loose cloth.
- Keep fingers away from all moving parts. Special care is required around the sewing machine needle.
- Always use the proper needle plate. The wrong plate can cause the needle to break.
- Do not use bent needles.
- Do not pull or push fabric while stitching. It may deflect the needle causing it to break.
- Wear safety glasses.
- Switch the sewing machine off (“0”) when making any adjustment in the needle area, such as threading needle, changing needle, threading bobbin, or changing presser foot, etc.
- Never drop or insert any object into any opening.
- Do not use outdoors.

- Do not operate where aerosol (spray) products are being used or where oxygen is being administered.
- To disconnect, turn all controls to the off (“0”) position, then remove plug from outlet.
- Do not unplug by pulling on cord. To unplug, grasp the plug, not the cord.
- The foot control is used to operate the machine. Never place other objects on the foot control.
- Do not use the machine if it is wet.
- If the LED lamp is damaged or broken, it must be replaced by the manufacturer or its service agent or a similarly qualified person, in order to avoid a hazard.
- If the cord connected with the foot control is damaged, it must be replaced by the manufacturer or its service agent or a similarly qualified person, in order to avoid a hazard.
- Only use the external power supply (if applicable), the foot controller and cords supplied with your machine. No other can be used. If damaged or lost, make sure to replace with identical parts. Replacement should be carried out by the manufacturer, its service agent or a similarly qualified person, to ensure safety and avoid a hazard.

For Overlock Machines only:

- Never operate without a cutter cover or a securely installed coverstitch table.

SAVE THESE INSTRUCTIONS

Federal Communication Commission Interference Statement

For the USA and Canada

Responsible party: Singer Sourcing Limited LLC
300 2nd Ave. S, Suite 300, Nashville, TN 37201, USA

Product name: HUSQVARNA® VIKING® Topaz™ 55Q sewing machine

This device complies with Part 15 of the FCC Rules. Operation is subject to the following two conditions: (1) This device may not cause harmful interference, and (2) this device must accept any interference received, including interference that may cause undesired operation.

To satisfy radio frequency exposure requirements, a separation distance of 8” (20 cm) or more should be maintained between this device and persons during device operation. To ensure compliance, operations at closer than this distance is not recommended. The built-in antenna used for this transmitter must not be co-located in conjunction with any other antenna or transmitter.

This equipment has been tested and found to comply with the limits for a Class B digital device, pursuant to Part 15 of the FCC Rules. These limits are designed to provide reasonable protection against harmful interference in a residential installation. This equipment generates, uses and can radiate radio frequency energy and, if not installed and used in accordance with the instructions, may cause harmful interference to radio communications. However, there is no guarantee that interference will not occur in a particular installation. If this equipment does cause harmful interference to radio or television reception, which can be determined by turning the equipment off and on, the user is encouraged to try to correct the interference by one of the following measures:

- Reorient or relocate the receiving antenna.
- Increase the separation between the equipment and receiver.
- Connect the equipment into an outlet on a circuit different from that to which the receiver is connected.
- Consult the authorized HUSQVARNA® VIKING® retailer or an experienced radio/TV technician for help.

The included interface cable should be used in order to ensure compliance with the limits for a Class B digital device.

 *Any changes or modifications not expressly approved by the party responsible for compliance could void the user's authority to operate this equipment.*

CE Declaration of Conformity

VSM Group AB Soldattorpsgatan 3, SE-554 74 Jonkoping, Sweden declare that the product:
Household Sewing Machine HUSQVARNA® VIKING® Topaz™ 55Q complies fully with
following EU directives:

- 2014/53/EU RED Directive

and that the relevant harmonized standards are applied as listed:

- EN 60335-1:2012, A13:2017, A1:2019, A2:2019, A14:2019, A15:2021, A16:2024
- EN 60335-2-28:2003, A1:2008, A11:2018
- EN 62233:2008
- EN 62311:2020
- EN 50564:2011
- EN 50014-1:2021
- EN 55014-2:2021
- EN 61000-3-2:2019, A1:2021
- EN 61000-3-3:2019, A1:2019
- EN 63000:2018
- EN 301 489–17 V3.24–2020
- EN 301 489-v2.1.1-2017
- EN 300 328 v2.2.2–2019
- EN 18031-1:2024
- EN 18031-2:2024

Jönköping, June 1, 2025

Carsten Raunsgaard

Sr. Manager Regulatory Compliance

TABLE OF CONTENTS

I	Introduction	9			
	Machine Overview	10			
	Front	10			
	Needle Area	10			
	Left Side	11			
	Right Side	11			
	Top	12			
	Accessory Tray Overview	12			
	Function Buttons	13			
	Needle Stop Up/Down	13			
	Presser Foot Up and Extra Lift	13			
	Presser Foot Down and Pivot	13			
	Cut Function	13			
	Immediate Tie-Off	13			
	Stitch Re-Start	13			
	Stop	14			
	Start/Stop	14			
	Reverse	14			
	Accessories	15			
	Included Accessories	15			
	Presser Feet	16			
	Stitch Overview	18			
	Utility Stitches	18			
	Stitch Menu Overview	21			
	Alphabets	21			
				Threading for Twin Needle	36
				Threading Tips and Hints	36
				Bobbin Winding	38
				Bobbin Winding using the Auxiliary Spool Pin	39
				Bobbin Winding Through the Needle	40
				Inserting the Bobbin	41
				Changing the Presser Foot	41
				Connect the Sensor One-Step Buttonhole Foot	42
				Getting Started with WiFi and CREATIVATE	42
2	Preparations	23	3	The Multi-Touch Screen	43
	Unpack the Machine	24		Main Functions	44
	Connect the Foot Control Cord	24		Home	44
	Connect the Power Cord and Foot Control	25		Save	44
	Pack Away After Sewing	26		Quick Help	44
	USB Ports	26		Common Functions	44
	Using a USB device	26		Top Bar	46
	LED Lights	26		Secondary Top Bar	46
	Free Arm	26		Fabric Selection	46
	Lower the Feed Teeth	27		Recommendations	46
	Manual Thread Cutter	27		Information	46
	Thread Sensor	27		Active Features	46
	Speed Control Slider	27	4	WiFi & CREATIVATE Services	47
	Spool Pins	28		WiFi Introduction	48
	Horizontal Position	28		Getting Started With WiFi	48
	Vertical Position	28		Firmware Updates	48
	Auxiliary Spool Pin	29		Firmware Update Using WiFi	48
	Spool Caps	29		Firmware Update Using a USB Device	48
	Threads	29		CREATIVATE Services	49
	Needles	31		CREATIVATE	49
	Important Needle Information	31		Design Catalog	49
	Changing the Needle	32		CREATIVATE Blog	49
	Threading	33		CREATIVATE App	49
	Threading the Upper Thread	33	5	Home Screen	51
	Selecting Correct Thread/Needle Combination	34		Home Screen— Overview	52
				Edit Machine Nickname	52
				User Profile	53
				Start New Session	53
				Continue from Saved State	53
				CREATIVATE	53
				User's Guide	53
				JoyOS ADVISOR™	54
				Sewing	54
				Get Started	56
				Advanced Features	56
				Accessories	56
				Needles	56
				Stabilizers	56
				Project Viewer	57

6	Sewing	59			
	Sewing Mode – Overview	60		Language	81
	Load a Stitch.....	61		Time Format.....	81
	Information and Sewing			Time Zone.....	81
	Recommendations.....	61		Timer Functions	81
	Stitch Settings	61		Machine Usage	81
	Stitch Width.....	61		Auto Power Off.....	81
	Stitch Positioning.....	62		Audio Volume	81
	Stitch Length.....	62		Audio Repeat	81
	Stitch Density.....	62		LED Work Light.....	82
	Mirroring.....	62		Units.....	82
	Buttonhole Slit Length.....	62		Personalize Settings.....	82
	Button Stitch Repetition.....	62		Machine Nickname.....	82
	Presser Foot Pressure.....	63		User Name	82
	EXCLUSIVE SENSOR SYSTEM™.....	63		Color Themes	82
	Balance	63		Bottom Bar Text.....	82
	Free Motion Options.....	63		Customize Your Workspace	82
	Tie-Off Options.....	64		Lock Screen	82
	Save Stitch	65		Always Show Timer in Top Bar	82
	Sewing Techniques.....	66		WiFi Settings.....	83
	Seam.....	66		CREATIVATE Settings.....	83
	Overcast.....	66		Machine Information.....	84
	Seam and Overcast.....	66	9	File Manager	85
	Baste.....	66		File Manager – Overview.....	86
	Blind Hem	67		File Formats	86
	Hem	67		Browse File Manager.....	86
	Buttonholes	67		Open a File or Folder.....	87
	Programmable Button Sew On.....	68		Select Multiple	87
	Tapering Stitches.....	69		Vault Folder	87
	Special Stitches For Optional Presser Feet	69		USB Device	87
	Exclusive Sewing Techniques.....	69		List/Thumbnail View	87
	Theme Stitches	69		Move up One Folder Level	87
	Embellished Stitches.....	70		Organize.....	87
	Pop-up Messages in Sewing	71		Create New Folder	88
				Rename a File or Folder	88
7	Sequence	73		Move a File or Folder.....	88
	Sequence – Overview	74		Copy a File or Folder	88
	Getting Started with Sequence.....	75		Delete a File or Folder	88
	Edit and Adjust Your Sequence	75		Pop-up Messages in File Manager.....	89
	Sequence Commands.....	76			
	Saving a Sequence	77	10	Maintenance	91
	Sew Your Sequence.....	77		Cleaning the Machine Exterior.....	92
	Adjust the Entire Sequence.....	77		Removing the Needle Plate and Cleaning	
	Using Sequence in Sewing Mode.....	77		the Bobbin Area	92
	Pop-up Messages in Sequence	77		Cleaning Under the Bobbin Area.....	92
				Replacing the Needle Plate.....	92
8	Settings	79		Troubleshooting.....	93
	Sewing Settings.....	80		Troubleshooting Connectivity	95
	Automatic Presser Foot Lift.....	80		Service	95
	Automatic Thread Cutter.....	80		Non-Original Parts and Accessories	96
	Stitch Limiting Options.....	80		Technical specification.....	96
	Needle Stop Position	80			
	Presser Foot Pressure.....	80			
	Tie-Off Options	80			
	Display & Audio Settings.....	81			

I Introduction

Machine Overview

Front

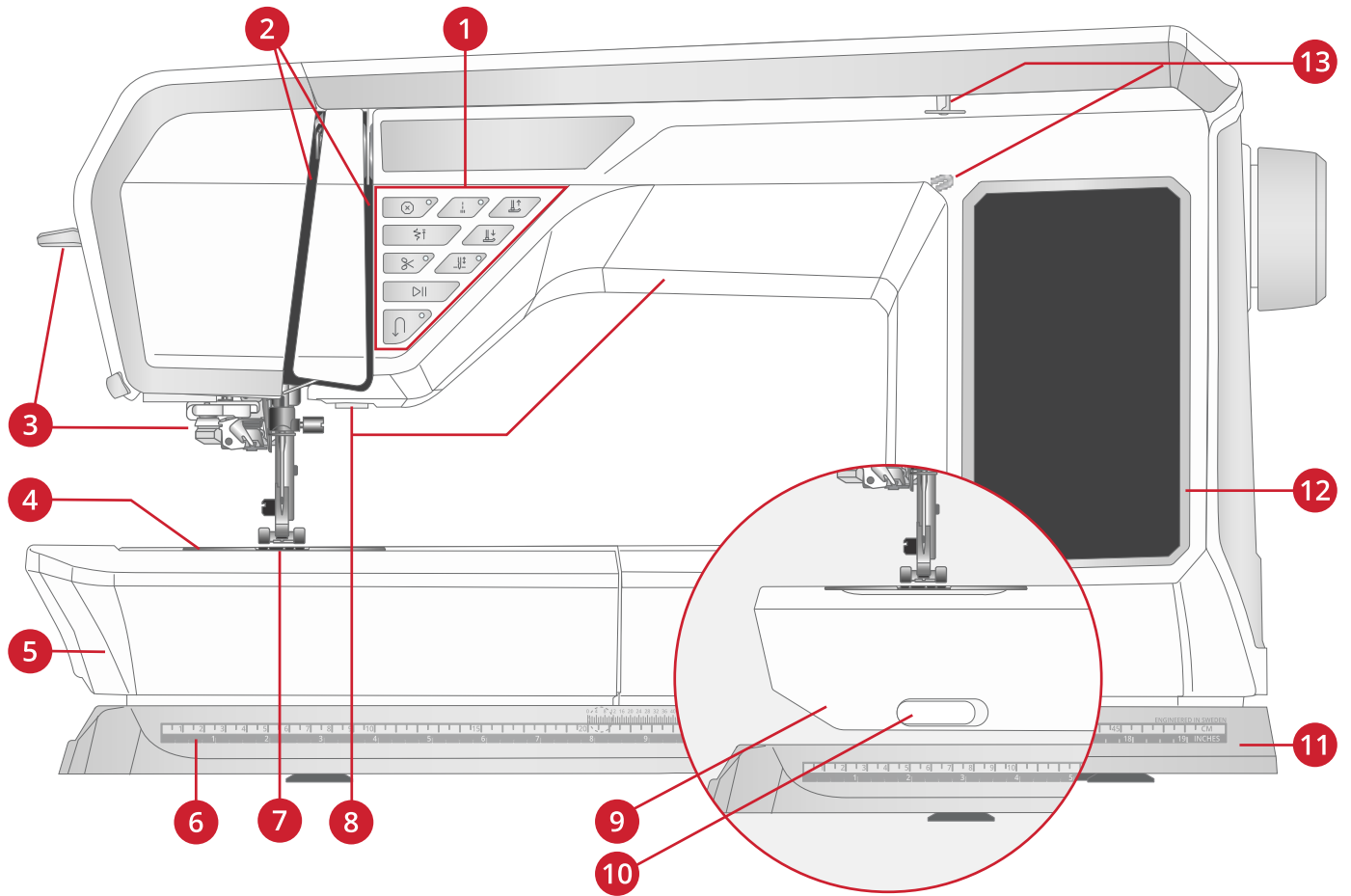

- | | | |
|---|---|----------------------------------|
| 1. Function buttons, see page 13 for detailed description | 6. Ruler | 11. Base plate |
| 2. Threading slots | 7. Feed teeth | 12. Multi-touch screen |
| 3. Automatic needle threader | 8. LED lights | 13. Bobbin winding thread guides |
| 4. Needle plate | 9. Free arm (remove the accessory tray to use the free arm) | |
| 5. Accessory tray | 10. Feed teeth lever | |

Needle Area

1. Automatic needle threader
2. Needle bar with needle clamp screw
3. Needle thread guide
4. Presser foot
5. Presser foot ankle
6. Presser foot bar

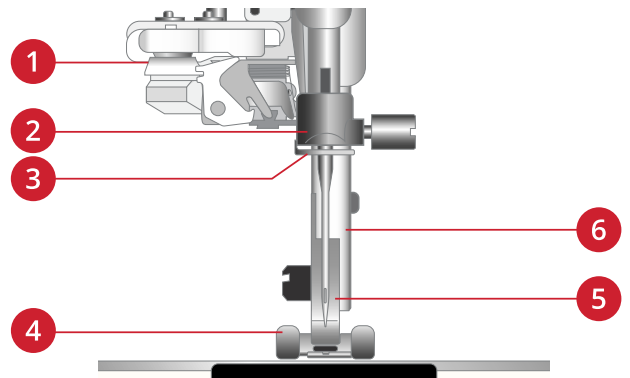

Left Side

1. Accessory socket
2. Thread cutter
3. Accessory tray sockets
4. Automatic needle threader

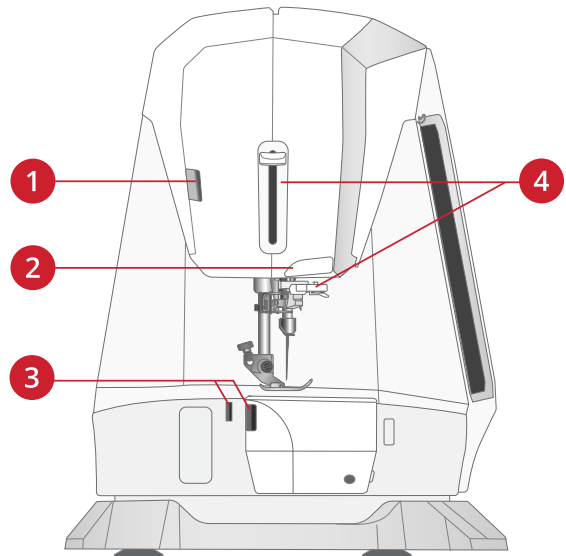

Right Side

1. Handwheel
2. Speaker
3. Speed control slider
4. ON/OFF switch, sockets for power cord and foot control. See [Connect the Power Cord and Foot Control](#), page 25.
5. Built-in USB port

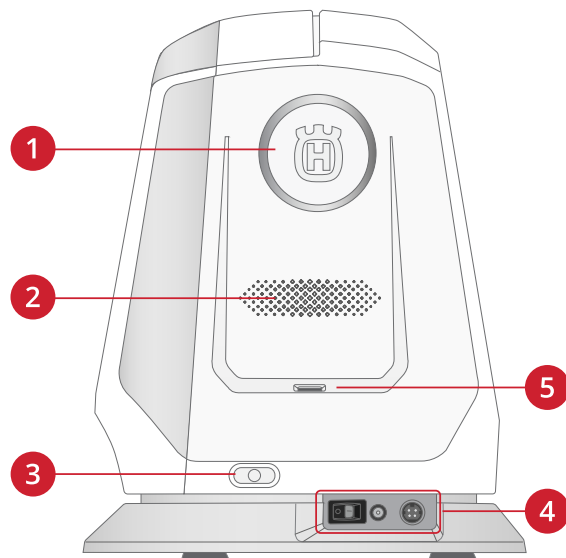

Top

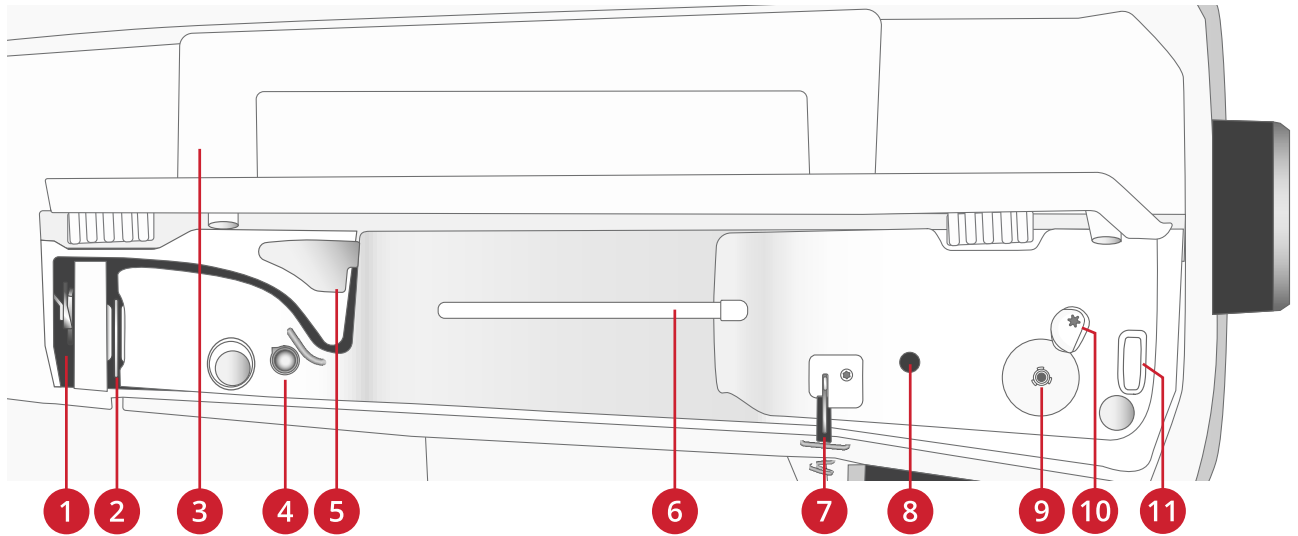

1. Thread take-up lever
2. Thread tension discs
3. Handle
4. Pre-tension disc
5. Thread guide
6. Main spool pin
7. Thread guide
8. Hole for auxiliary spool pin
9. Bobbin winder
10. Bobbin winder lever
11. Thread cutter

Accessory Tray Overview

The accessory tray features special compartments for presser feet and bobbins, plus space for needles and other accessories. Store the accessories in the tray so they are easily accessible.

1. Space for accessories
2. Spaces for presser feet
3. Space with hole for Buttonhole Foot C
4. Spaces for bobbins

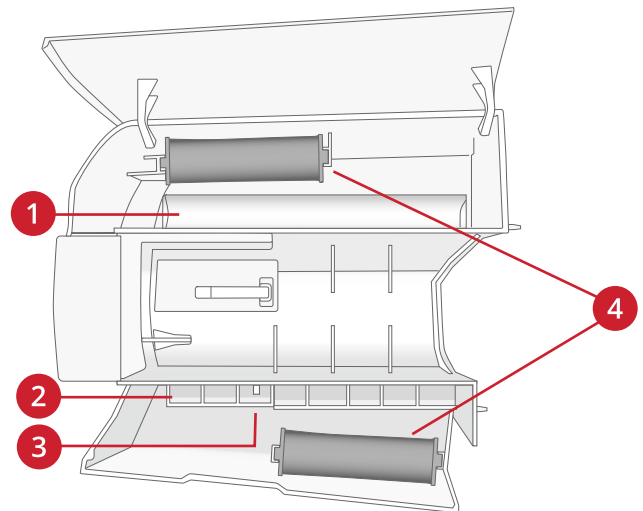

Function Buttons

1. Immediate tie-off
2. Stop
3. Stitch restart
4. Cut function
5. Start/stop
6. Reverse
7. Needle stop up/down
8. Presser foot down and pivot
9. Presser foot up and extra lift

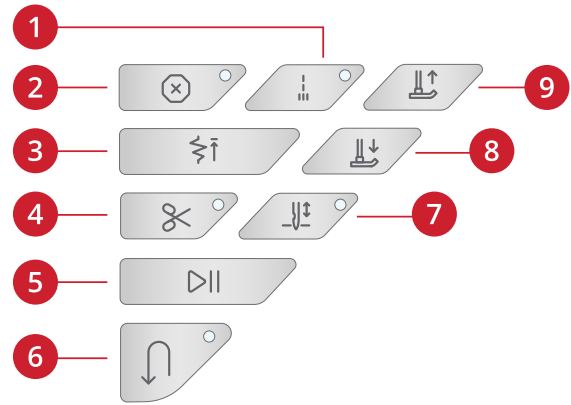

Needle Stop Up/Down

Touch needle stop up/down to set the position of the needle when you stop sewing. The needle will move up or down when you touch the button. The indicator light intensifies when needle stop down is set.

Tip: You can also tap the foot control to raise or lower the needle once you stop sewing. Tapping the foot control does not change the set stop position.

Presser Foot Up and Extra Lift

Touch the presser foot up button once to raise the presser foot. Touch again and the presser foot will raise to extra lift position. Lower the feed teeth manually to make it easier to get heavy fabric under the presser foot.

Presser Foot Down and Pivot

The presser foot is lowered automatically when you start sewing. To lower the presser foot before starting to sew, touch the presser foot down and pivot button. The presser foot will be completely lowered and the machine firmly holds the fabric. Touch presser foot down again to go to pivot position.

Cut Function

Touch the cut function button and your machine cuts the upper and bobbin threads and raises the presser foot and needle.

To cut threads at the end of a stitch or stitch sequence, touch the cut function button while sewing. The indicator light will illuminate, alerting you that a cut is requested. When the stitch or stitch sequence is completed, your machine cuts the upper and bobbin threads and raises the presser foot and needle.

Note: If automatic presser foot lift has been deselected in sewing settings the presser foot will not be raised when using the cut function.

Note: Some optional accessories are attached in the two small circular holes in the needle plate just above the bobbin cover. Do not use the cut function when an accessory is attached in these holes as that may interfere with the automatic thread cutter located under the needle plate

Immediate Tie-Off

Press immediate tie-off while sewing and your machine sews a few tie-off stitches and stops automatically. By touching the tie-off button once more while the action indicator is lit, the function can be turned off.

Stitch Re-Start

When you stop sewing in the middle of a stitch, touch stitch re-start to begin sewing at the beginning of the stitch. The stitch or stitch sequence will remember any special settings you made.

Stop

Touch STOP when sewing to conclude a stitch or stitch program. Your machine fixes the thread and stops automatically when the stitch or stitch program has been completed. Touch STOP before starting to sew and your machine sews only one repetition of the stitch. Only one stitch is displayed on the screen. The indicator next to the STOP button is lit when the STOP function is active. To cancel the function, touch STOP again or select a new stitch. The STOP function is cancelled when the stitch is completed.

Start/Stop

Touch the start/stop button to start and stop the machine without using the foot control. Touch start/stop to begin and touch again to stop.

Reverse

When reverse is active, the reverse indicator illuminates. For permanent reverse, touch the reverse button once before starting to sew. The reverse indicator will illuminate and the machine sews in reverse until you touch the button again to cancel. If you press the reverse button while sewing, the machine will sew in reverse for as long as you keep the button pressed.

Reverse is also used when sewing manual buttonholes, darning stitches and tapering stitches to step between the parts of the stitch.

Accessories

Included Accessories

1. Thread net
2. Screwdriver
3. Seam ripper
4. Brush
5. Auxiliary spool pin
6. Spool cap, small
7. Spool cap, medium
8. Spool cap, large (2)
9. Bobbins (5)
10. Multipurpose tool/Button reed
11. Felt Pad
12. Edge/Quilting guide (used attached to presser foot ankle)

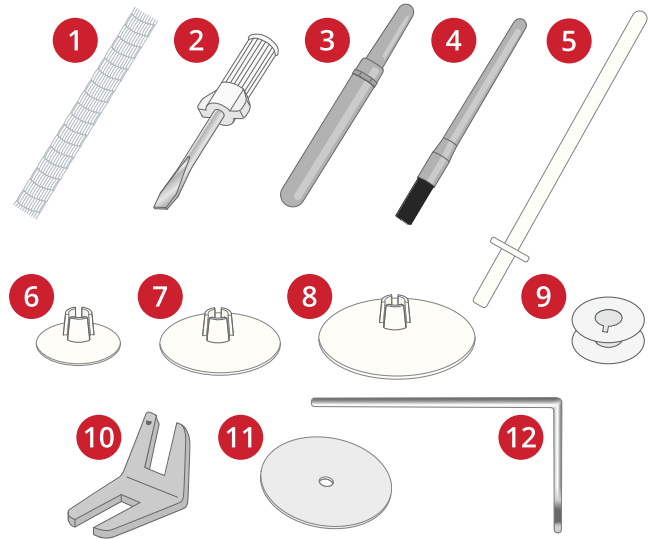

Included Accessories Not in Picture

- Cover for machine
- Foot control
- Power cord
- Needles

Presser Feet

Note: For the best sewing results, use only presser feet designed for and compatible with your Topaz™ 55Q machine.

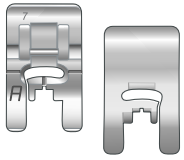

Utility Foot A

Snapped onto the machine upon delivery. Used mainly for straight stitching and zigzag stitching with a stitch length longer than 1.0mm.

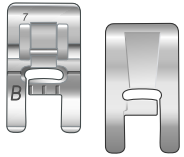

Decorative Stitch Foot B

For sewing close zigzag stitches (satin stitches) with less than 1.0mm stitch length, other utility stitches or decorative stitches, use this foot. The tunnel on the underside of the foot is designed to feed smoothly over the stitches.

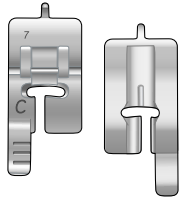

Buttonhole Foot C

For manual buttonholes. This foot has guidelines to determine buttonhole length. The middle measures 5/8" (15mm) from the fabric edge. The two tunnels on the underside of the foot ensure smooth feeding over the buttonhole columns. The finger on the back of the foot holds cording for corded buttonholes.

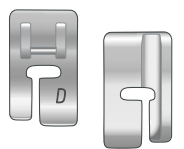

Blindhem Foot D

For blindhem stitches. The inner edge of this foot guides the fabric. The right toe of the foot is designed to ride along the hem edge.

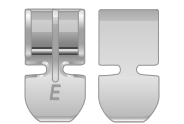

Zipper Foot E

This foot can be snapped on either to the right or to the left of the needle. This makes it easy to sew both sides of the zipper. Move needle position to right or left to sew closer to zipper teeth or for covering large cording.

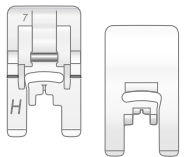

Non-Stick Glide Foot H

This foot, with a non-stick coating underneath, is used when sewing foam, vinyl, plastic, or leather to keep these materials from sticking to the foot.

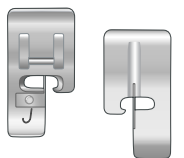

Edging Foot J

Used for overcasting and seam/overcasting, with stitches that have a stitch width of 5.0 and 5.5mm. Stitches form over the pin which prevents puckering at the edge of the fabric.

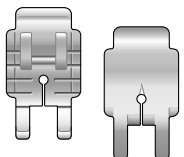

Quilter's 1/4" Piecing Foot P

Used when piecing quilt blocks. The foot has distance guideline marks 1/4" (6mm) and 1/8" (3mm) from the needle.



Embroidery/Darning Foot R

Used for free motion embroidery, free motion quilting, free motion stitching and free motion darning. When using this foot, select free motion floating in the free motion options pop-up in sewing mode.

This foot can also be used for hoop embroidery.

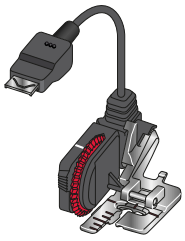

Sensor One-Step Buttonhole Foot

Plug into the machine then enter the desired buttonhole length to sew sensor one-step buttonholes. The middle mark measures a $\frac{5}{8}$ " (15mm) from fabric edge.

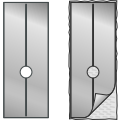



































Self-Adhesive Glide Plates

















If sewing on foam, vinyl, plastic, or leather, the material can stick to the foot and prevent the sewing machine from feeding properly. When using any of the above materials, sew on a piece of scrap fabric, to make sure the machine feeds smoothly. If not, fasten the self-adhesive glide plate to the underside of the presser foot.

Stitch Overview

Utility Stitches

Stitch	№	Presser foot	Name	Description
	A1	A	Straight stitch, left needle position	For all types of sewing.
	A2	A	Straight stitch, center needle position	For all types of sewing.
	A3	A	Straight stitch, right needle position	For all types of sewing.
	A4	A	Straight stitch with reinforced tie-off	For all types of sewing. Begins and ends with forward and reverse stitches.
	A5, A6, A7	A	Stretch stitch, left, center and right needle position	For seams in tricot and stretch fabrics.
	A8, A9, A10	A	Zigzag, left, center and right needle position	For sewing on lace, trims and appliqués.
	A11	B	Reinforced zigzag stitch	For joining fabric edge to edge or overlapping in leather. For decorative sewing.
	A12	A	Three-step zigzag	For overcasting, mending, sewing on patches and elastic. Suitable for light and medium weight fabrics.
	A13		Two-step zigzag	For joining two pieces of lace, and for elastic shirring.
	A14, A15, A16	A	Reinforced straight stitch, left, center and right needle position	Triple and elastic, for reinforced seams. For top stitch, increase the stitch length.
	A17	A	Gathering stitch	No fix stitch in the beginning of the seam for easy gathering.
	A18	J	Seam/overcast stitch	Seam and overcast in one step along the edge or trim later. For light stretch and non-stretch fabrics.
	A19	B	Stretch seam/overcast stitch	Seam and overcast in one step along the edge or trim later. For medium and heavy stretch fabrics.
	A20	B	Double overlock stitch	Seam and overcast in one step along the edge or trim later. For heavy stretch and heavy woven fabrics.
	A21	B	Overlock stitch	Seam and overcast in one step along the edge or trim later. For medium stretch fabrics.
	A22	B	Flatlock stitch	Decorative hems and overlapped seams, belts and bands. For medium/heavy stretch fabrics.
	A23	B	Elastic or smocking stitch	Sew over two rows of elastic thread for elastic shirring.
	A24	D	Stretch blind hem stitch	Blind hems in medium and heavy stretch fabrics.

Stitch	№	Presser foot	Name	Description
	A25	D	Woven blind hem stitch	Blind hems in medium and heavy woven fabrics.
	A26	A	Shell edge stitch	For edging, sewing over the edge on light woven fabrics. Sew woven fabrics on bias.
	A27	B	Elastic/casing stitch	For overlapped seams in tricot. To sew casing over narrow elastic.
	A28	A	Serpentine stitch	For mending and elastic applications.
	A29	B	Bridging stitch	For joining two pieces of fabric with finished edges and for elastic shirring.
	A30	B	Bartack stitch	Reinforce pockets, shirt openings, belt loops as well as at lower end of a zipper.
	A31	B	Bartack, manual	Reinforce pockets, shirt openings, belt loops as well as at lower end of a zipper.
	A32	A	Belt loop stitch	For securing belt loops.
	A33	A	Darning stitch (forward and backward)	Darn and mend small holes in work clothes, jeans, tablecloths and linen towels. Stitch over hole, touch reverse for continuous darning and auto stop.
	A34	A	Darning stitch (side to side)	For mending small tears.
	A35	A	Reinforced darning stitch	Darn and mend work clothes, jeans, tablecloths and linen towels. Stitch over hole, touch reverse for continuous darning and auto stop.
	A36	B	Darning stitch (four-step)	A group of four stitches perfect for mending small tears. Stitch #1 and #3 are sewn in a forward motion, stitch #2 and #4 are sewn backwards. To change stitch and direction touch the reverse button. <i>Tip: Press fusible interfacing on the wrong side before mending the tear.</i>
	A37	A	Basting stitch	For temporary seams. The long stitches and reduced tension make the seams easy to unravel.
	A38	A	Straight basting stitch	To baste, press the foot control and the machine will make two stitches, stop and raise the foot. When the presser foot lifts, move the fabric to the next baste position and press the foot control. Lower the feed teeth before starting to sew.
	A39	A	Zigzag basting	To baste, press the foot control and the machine will make two stitches, stop and raise the foot. When the presser foot lifts, move the fabric to the next baste position and press the foot control. Lower the feed teeth before starting to sew.
	A40	Sensor Buttonhole foot/C	Wide bartack buttonhole	For medium and heavy fabrics with extra cutting space.
	A41	Sensor Buttonhole foot/C	Bartack buttonhole	For most fabric weights.

Stitch	№	Presser foot	Name	Description
	A42	Sensor Buttonhole foot/C	Rounded bartack buttonhole	For light weight fabrics.
	A43	Sensor Buttonhole foot/C	Keyhole buttonhole	Square end for tailored jackets, coats, etc.
	A44	Sensor Buttonhole foot/C	Tapered keyhole buttonhole	Tapered end for tailored garments.
	A45	Sensor Buttonhole foot/C	Decorative fashion buttonhole	For most fabric weights.
	A46	Sensor Buttonhole foot/C	Heavy duty buttonhole	With reinforced bartacks
	A47	Sensor Buttonhole foot/C	Heavy reinforced buttonhole	For utility and heavy fabrics.
	A48	C	Medium/heavy reinforced buttonhole	For medium and heavy fabrics.
	A49	C	Medium reinforced decorative buttonhole	For medium fabrics.
	A50	Sensor Buttonhole foot/C	Heirloom buttonhole	For hand look on fine and delicate fabrics. <i>Tip: For jeans buttonholes, increase length and width of the buttonhole. Use thicker thread.</i>
	A51	Sensor Buttonhole foot/C	Rounded heirloom buttonhole	For hand look on fine and delicate fabrics.
	A52	A	Leather buttonhole (straight stitch)	For leather and suede.
	A53	A	Bound buttonhole (straight stitch)	With extra cutting space for bound buttonholes.
	A54	-	Automatic button sewing	For sewing on buttons.
	A55	B	Round eyelet	For belts, laces, etc.
	A56	B	Teardrop eyelet	For laces, embellishments.
	A57	B	Oval eyelet	For laces, embellishments.

Stitch Menu Overview

There are several different stitch menus with stitches for all purposes.

For detailed description of a stitch, use the [Quick Help](#) function.

Stitch Menu Name

- A — Utility Stitches (see [stitch table](#) for detailed descriptions)
- B — Appliqué Stitches
- C — Heirloom Stitches
- D — Quilt Stitches
- E — Crafting Stitches
- F — Decorative Stitches
- G — Vintage Stitches
- H — Children Stitches
- I — Scallop Stitches
- J — Theme Stitches
- K — Single Motif Stitches
- L — Specialty Stitches
- M — Tapering Stitches
- N — Pictogram Stitches

Alphabets

Stitch fonts are available in block, brush line, outline, palace script and Cyrillic alphabets.

2 Preparations

Unpack the Machine

After lifting the machine out of the box and removing all packing material and the plastic bag, wipe the machine, particularly around the needle and needle plate to remove any oil before sewing.

Note: Your Topaz™ 55Q machine is adjusted to provide the best stitch result at normal room temperature. Extreme hot and cold temperatures can affect the sewn results.

Connect the Foot Control Cord

Among the accessories you will find the foot control cord. Connecting the foot control cord to the foot control is only necessary the very first time you are going to use the machine.

1. Turn the foot control over. Connect the cord to the socket inside the space of the foot control. Push firmly to make sure it is properly connected.
2. Lay the cord in the slot on the underside of the foot control.

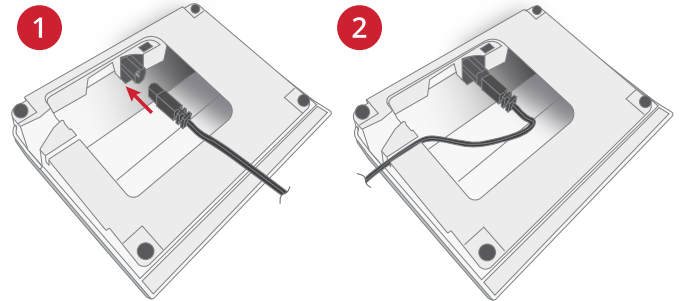

Connect the Power Cord and Foot Control

Among the accessories you will find the power cord and the foot control.

The power supply unit used for your machine differs between countries. Below both versions are described.

Use the description suitable for the power supply unit delivered with your machine.

Note: Before plugging in the foot control, check to ensure that it is type "FR5" (see underside of foot control).

Note: Only use the power cord supplied with your machine. No other cord can be used. If the cord is damaged or lost, make sure to replace it with the same type of cord, available at an authorized HUSQVARNA® VIKING® dealer.

Power Supply Type #1

The power cord has a power supply unit (PSU) (A). The fixed cord (B) attached to the PSU unit, should be connected to the sewing machine. The loose cord (C) should be connected to the socket (D) in the PSU unit and then to the wall socket.

Connect the cord (B) to the rear socket (1) on the bottom right side of the machine. Plug the power cord into the wall socket.

Power Supply Type #2

Before using the machine for the first time an AC-plug must be mounted to the power supply unit in order to plug it into an electrical outlet. Slide on the correct AC-plug until it clicks in place. Make sure the plug is firmly attached.

Connect the cord (B) to the rear socket (1) on the bottom right side of the machine. Plug the power cord into the wall socket.

Foot Control and Power

Pull out the cord (E) from the foot control. Connect the foot control cord to the socket (2) on the bottom right side of the machine.

Press the ON/OFF switch (3) to "I" to turn on power and light.

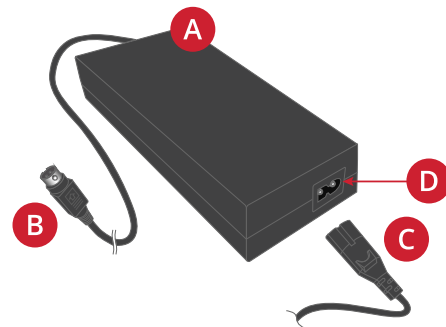

Power Supply Type #1

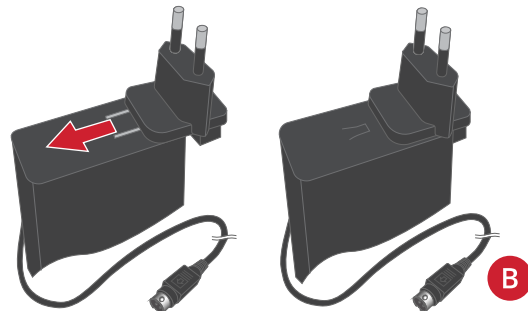

Power Supply Type #2

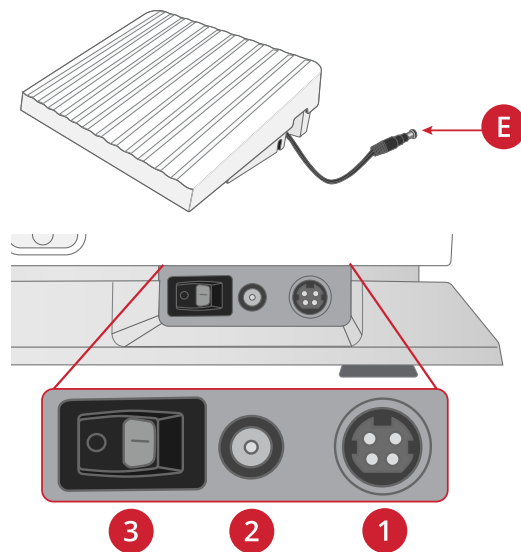

Pack Away After Sewing

1. Press the ON/OFF switch to "O".
2. Unplug the cord from the wall socket and then from the machine.
3. Unplug the foot control cord from the machine. Wind the foot control cord and place it inside the space on the underside of the foot control.
4. Place all accessories in the accessory tray. Slide the tray on to the machine around the free arm.
5. Place the foot control in the space above the free arm.
6. Put on the cover.

USB Ports

Your machine has a USB port for connecting USB devices such as a memory stick. USB plugs can only be inserted one way – do not force them into the ports! To remove, carefully pull the USB device out straight.

Note: Make sure that the USB stick you use has the format FAT32.

Using a USB device

The external device button in file manager is only active when a device is connected to a machine USB port.

Note: Do not remove the USB device if a loading spinner is shown on the screen or while the file manager is shown. Removing the device at that time can damage the files on your USB device.

LED Lights

Your machine has LED lights which distribute the light evenly over the sewing area and eliminate shadows. You can adjust the brightness of the light in the settings menu.

Free Arm

To use the free arm, slide off the accessory tray. When attached, a hook keeps the accessory tray locked to the machine. Remove the tray by sliding it to the left.

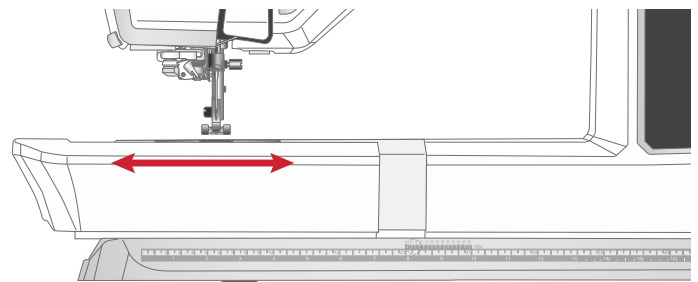
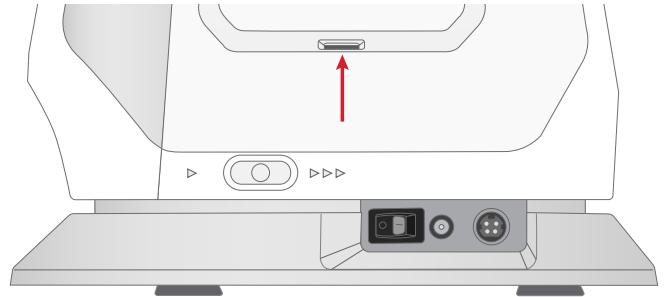

Lower the Feed Teeth

The feed teeth are lowered when you move the switch on the front of the free arm to the right.

Move the switch to the left if you wish to raise the feed teeth. The feed teeth will raise as you begin to sew.

The feed teeth should be lowered when sewing on buttons and for free motion sewing.

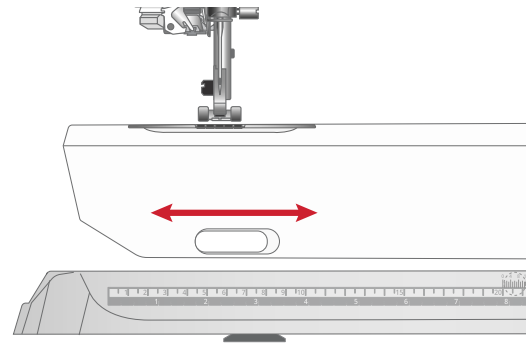

Manual Thread Cutter

There are three manual thread cutters on your machine.

- The first one (A) is close to the bobbin winder spindle for cutting the thread before and after winding.
- The second one (B) is on the left side of the machine for manually cutting top and bobbin thread. Bring both threads into the cutter from the back to the front and pull towards you to cut the threads.
- The third one (C) is next to the bobbin area for cutting the bobbin thread after placing the bobbin in the machine.

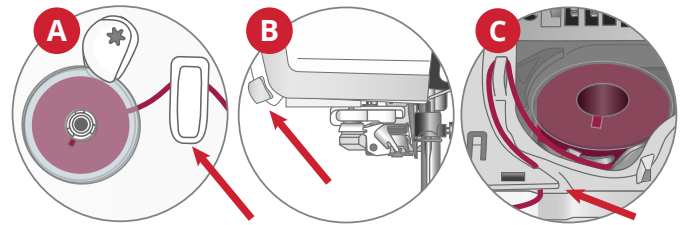

Thread Sensor

If the needle thread breaks or bobbin thread is running low, the machine stops and a pop-up appears on the screen.

If needle thread breaks: Remove the thread completely, re-thread the machine and touch OK in the pop-up.

If bobbin thread is running low: You can continue sewing without closing the pop-up before the bobbin thread runs out completely. This gives you an opportunity to plan where to stop and change the bobbin. When the bobbin is replaced with a full one, touch OK in the pop-up.

Speed Control Slider

The speed control slider sets the sewing speed. To increase sewing speed, slide the slider backwards, to decrease sewing speed, slide the towards you.

A pop-up appears on screen when adjusting the slider, indicating which speed level is set. The speed setting is also shown in the information area.

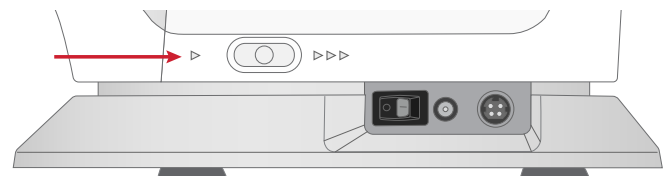

Spool Pins

Your machine has two spool pins; a main spool pin, and an auxiliary spool pin. The spool pins are designed for all types of thread. The main spool pin is adjustable and can be used in a horizontal position (the thread reels off the stationary spool) or in a vertical position (the thread spool rotates). Use the horizontal position for all regular sewing threads and the vertical position for large spools or specialty threads.

Use the main spool pin (A) when threading the upper thread and for bobbin winding through the needle.

Use the auxiliary spool pin (B) for a second spool when sewing with a twin needle or when winding from another thread spool.

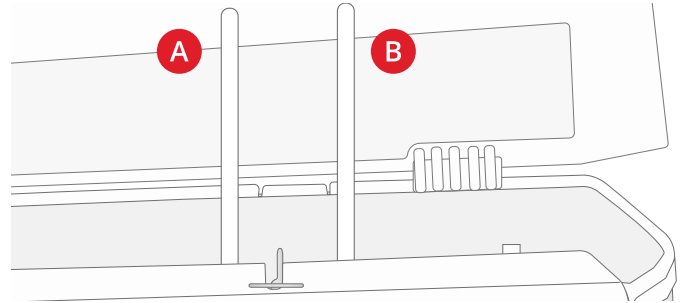

Main spool pin (A) and auxiliary spool pin (B)

Horizontal Position

Lift the spool pin up slightly from its horizontal position to easily place the thread spool on the pin. The thread should reel over the top, in a counterclockwise direction, as shown in the picture. Slide on a spool cap and then move the spool pin back to the horizontal position.

Use a spool cap slightly larger than the thread spool. For narrow thread spools, use a smaller spool cap in front of the spool (A). For large thread spools, use a larger spool cap in front of the spool (B).

The flat side of the spool cap should be pressed firmly against the spool. There should be no space between spool cap and thread spool.

Note: Not all thread spools are manufactured in the same way. If you experience problems with the thread, turn it in the opposite way or use the vertical position.

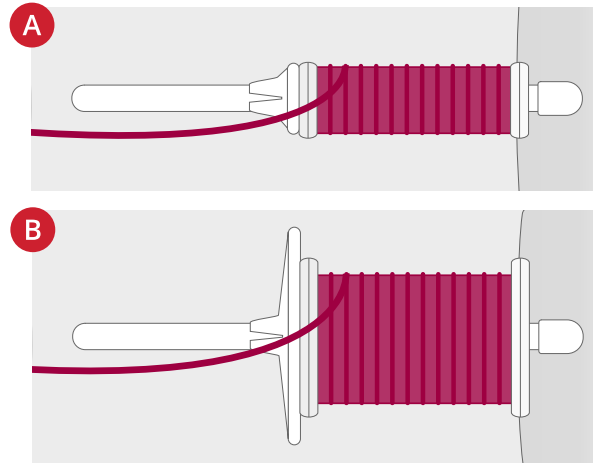

Vertical Position

Lift the spool pin up and all the way to the right. Slide on the large spool cap. For spools smaller than the medium size spool cap or when using specialty threads, place a felt pad under the thread spool to prevent the thread from reeling off too fast. For larger spools, the felt pad is not needed.

Note: No spool cap should be placed on top of the spool as this prevents the spool from rotating.

Note: When the spool pin is used in the vertical position, the thread tension might need to be adjusted manually.

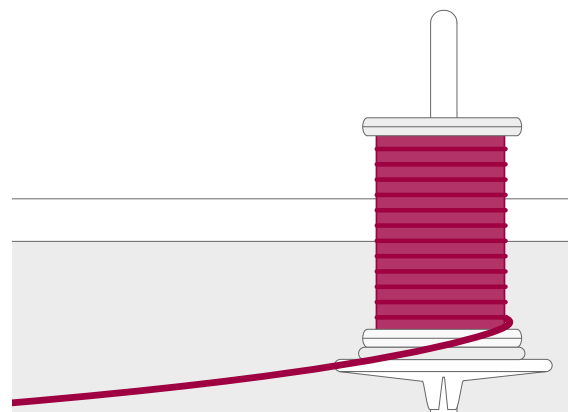

Auxiliary Spool Pin

The auxiliary spool pin is used for a second spool when sewing with a twin needle.

It can also be used when winding from another thread spool without un-threading the machine.

Insert the auxiliary spool pin in the hole on the top of the machine. Slide on a spool cap. For spools smaller than the medium size spool cap, place a felt pad under the thread spool to prevent the thread from reeling off too fast. For larger spools, the felt pad should not be used.

Spool Caps

Spool caps in three sizes are included with your machine. Always use a spool cap slightly larger than the thread spool to prevent the thread from snagging. The flat side of the spool cap should be pressed firmly against the spool. There should be no space between the spool cap and the thread spool.

When using the vertical spool pin position, no spool cap is needed except when the thread on the spool is running low. If the thread is snagging on the top of the thread spool, place a spool cap on top, but do not press the spool cap all the way down.

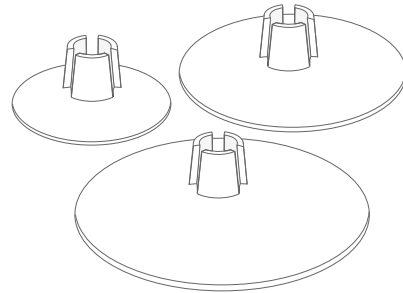

Threads

There are many threads on the market today developed for different purposes.

Your Topaz™ 55Q machine is designed for many types of threads and spool sizes. See [Threading Tips and Hints, page 36](#) for information on achieving optimal results with different types of thread and different sizes/styles of thread spools.

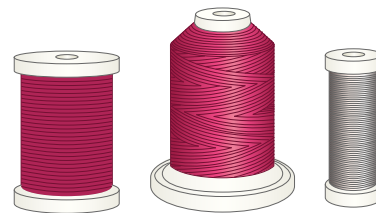

All Purpose Sewing Thread

All purpose sewing thread is made of synthetic, cotton or cotton covered polyester. This type of thread is used for most sewing projects, including garments, home decor, and quilting.

Embroidery Thread

Embroidery thread is made from a variety of fibers: rayon, polyester, acrylic or metallic. These threads create a smooth glossy appearance for embroidery and other decorative stitching.

Embroidery thread is not typically used in the bobbin unless both sides of the project will be seen. A light weight, embroidery bobbin thread is often used in the bobbin instead. The lighter weight thread does not build up under the embroidery.

Note: When using a metallic or a flat film thread for embroidery, you may need to use a needle with a larger eye and lower the embroidery speed.

Transparent Thread

Transparent thread, also called monofilament thread, is a single clear synthetic thread. It is used for quilting and other sewing techniques. When winding a bobbin, wind at half speed and fill the bobbin half full.

Needles

The sewing machine needle plays an important role in successful sewing. Use only quality needles. We recommend needles of system 130/705H. The needle package included with your machine contains needles of the most frequently used sizes.



Be sure to match the needle to the thread you are using. Heavier threads require a needle with a larger needle eye. If the needle eye is too small for the thread the needle threader may not work properly.

Universal Needle

Universal needles have a slightly rounded point and come in a variety of sizes. For general sewing in a variety of fabric types and weights.



Stretch Needle

Stretch needles have a special scarf to eliminate skipped stitches when there is a flex in the fabric. For knits, swimwear, fleece, synthetic suedes and leathers.



Embroidery Needle

Embroidery needles have a special scarf, a slightly rounded point and a slightly larger eye to avoid damage to thread and materials. Use with metallic and other specialty threads for embroidery and decorative sewing.



Denim Needle

Denim needles have a sharp point to penetrate tightly woven fabrics without deflecting the needle. For canvas, denim, microfibers.



Wing Needle

Wing needles have wide wings on the side of the needle to poke holes in the fabric when sewing entredeux and other hemstitches on natural fiber fabrics.

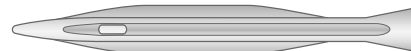

Important Needle Information



Change the needle often. As a general rule, needles should be changed every 6-8 hours of actual stitching time.

Always use a straight needle with a sharp point (A).

A damaged needle (B) can cause skipped stitches, breakage or snapping of the thread. It can also damage the needle plate.

Do not use asymmetrical twin needles (C), they can damage your sewing machine.

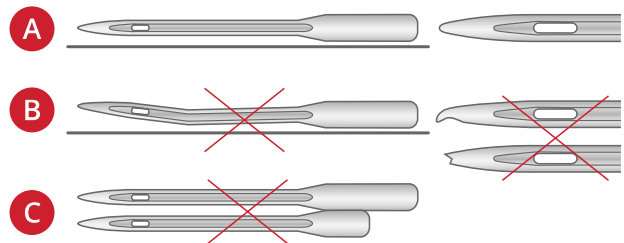

Changing the Needle

1. Use the hole in the multipurpose tool to hold the needle.
2. Loosen the needle screw.
3. Remove the needle.
4. Insert the new needle using the multipurpose tool. Push the new needle upwards with the flat side away from you until it will go no further.
5. Tighten the needle screw carefully.

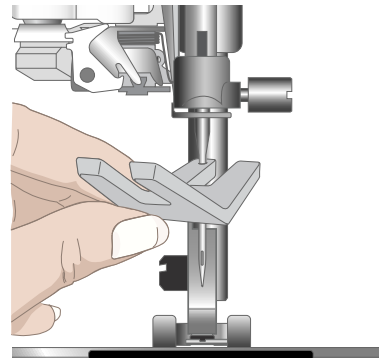

Threading

Threading the Upper Thread

Make sure that the presser foot is raised and the needle is in the up position.

1. Place the thread spool on the main spool pin and fit a spool cap of the right size.
2. Hold the thread with two hands as illustrated. Floss the thread under the thread guide (A) from back to front. Pull thread back into and through threading slot as shown.
3. Place the thread under the thread guide (B) and over thread guide (C).

Note: Continue to hold the thread lightly next to the thread guide (A) throughout the threading process. This will create a bit of tension on the thread and ensure that the thread is properly seated in the threading path.

4. Pull the thread between the thread tension discs (D). Thread down through the right threading slot and then upwards through the left threading slot. Bring the thread from the right into the take-up lever (E) until it clicks into place (F), and down in the left threading slot to the last thread guide (G) just above the needle.
5. Thread the needle using the needle threader or manually from front to back.

Note: The weight and irregular surface of specialty threads such as metallic increases the amount of friction on the thread. By reducing the tension, the risk of needle breakage and thread breakage is reduced.

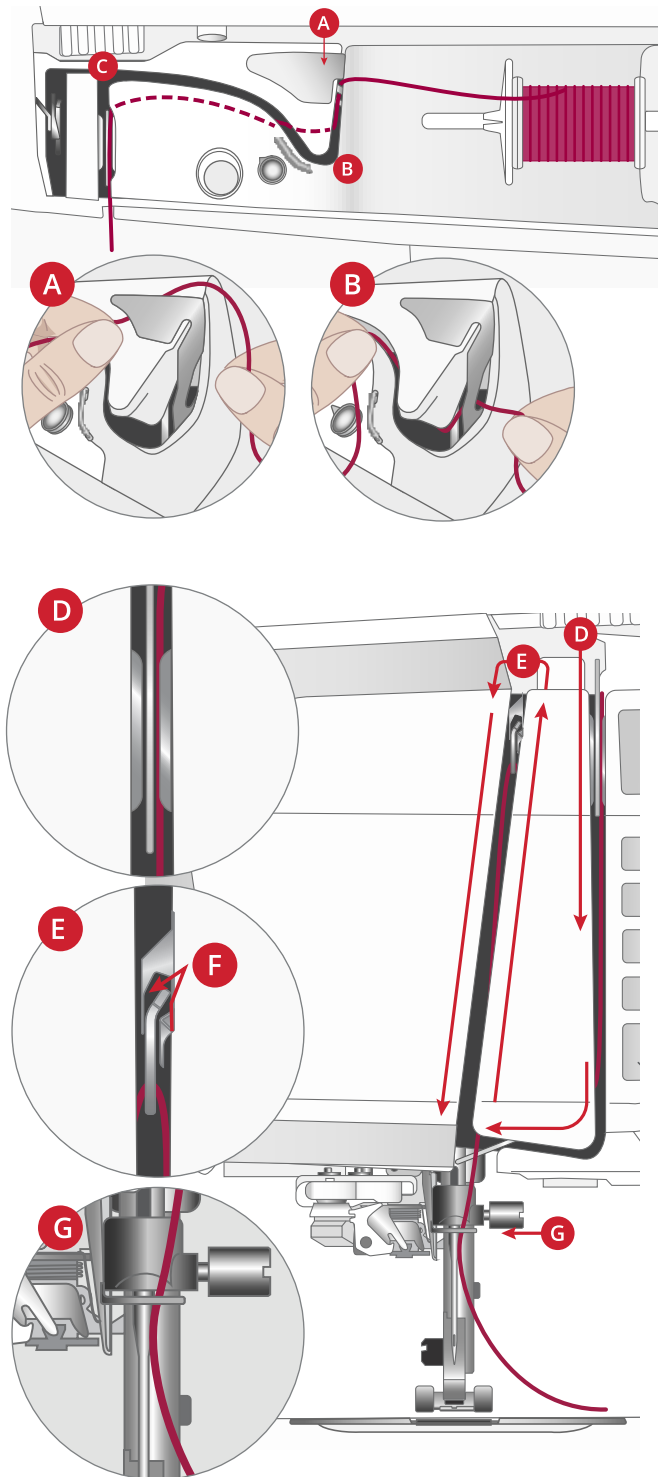

Automatic Needle Threader

The needle threader allows you to thread the needle automatically. The needle must be in the up position to use the needle threader.

1. Press the presser foot down button, followed by the needle up button to make sure they are in the correct position.
2. Place the thread under the hook (A) and pull it between the discs (B) until it “clicks” into place.
3. Pull the thread up to the thread cutter (C) and cut excess thread by pulling the thread from back to front into the thread cutter.
4. At the left side of the sewing machine is the needle threader lever (D). In a rapid movement, push the lever down and release it. The needle threader will be lowered and thread the needle.
5. Pull out about 4" (10cm) of thread beyond the needle eye. Press the presser foot up button to raise the presser foot. Place the thread under the presser foot.

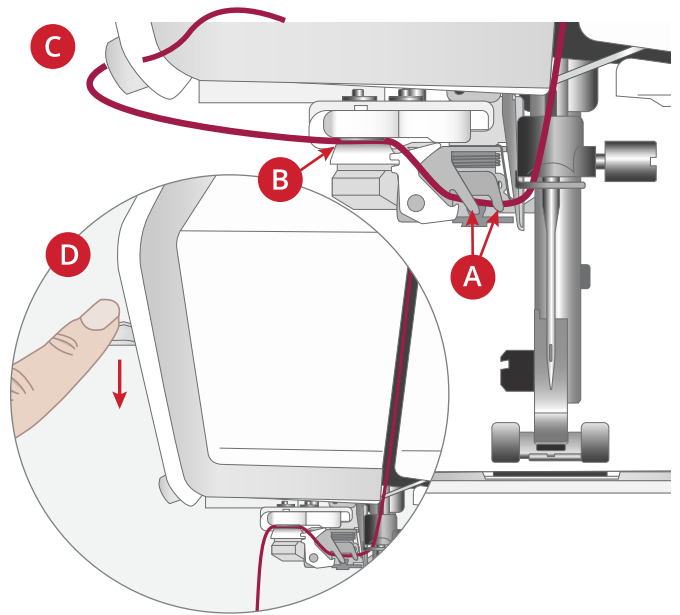

The needle threader is designed to be used with needles size 70-120. You cannot use the needle threader with needles size 65 or smaller, wing needles, twin needles or triple needles.

Specialty threads such as invisible and other stretchy threads, metallic or flat metallic threads, and some heavy weight threads may not be caught correctly by the hook on the needle threader. If this happens, the needle will not be threaded. Try using the needle threader again or thread the needle manually.

When threading the needle manually, make sure that the needle is threaded from front to back.

Selecting Correct Thread/Needle Combination



The combination of the thread weight and the needle size is extremely important when using the needle threader. Unsuitable combinations, such as using a heavy weight thread for a fine needle, may cause damage to the needle threader.

Avoid using fine needles with heavy fabrics to reduce the risk of bending the needle. Using the needle threader with a bent needle may cause damage to the needle threader.

Fabric		Thread	Needle
Woven light	Chiffon, organza, batiste, challis, crepe de chine, etc.	Light weight threads: <ul style="list-style-type: none"> • fine cotton, polyester or silk sewing thread • rayon embroidery thread 	Universal 130/705H 70/10-80/12
Woven medium	Calico, quilting fabrics, crepe, broadcloth, velvet, etc.	Medium weight threads: <ul style="list-style-type: none"> • fine/normal cotton or polyester sewing thread • rayon embroidery thread 	Universal 130/705H 80/12-90/14
Woven heavy	Denim, tweed, canvas, terrycloth, etc.	Medium/heavy weight threads: <ul style="list-style-type: none"> • normal cotton or polyester sewing thread • top stitching thread • rayon embroidery thread 	Universal 130/705H 90/14-110/18
Stretch light	Tricot, single knit jerseys, etc.	Light weight threads: <ul style="list-style-type: none"> • fine cotton or polyester sewing thread • rayon embroidery thread 	Stretch 130/705H-S 80/12
Stretch medium	Sweater knits, double knit, velour, swimwear, etc.	Medium weight threads: <ul style="list-style-type: none"> • normal cotton or polyester sewing thread • rayon embroidery thread 	Stretch 130/705H-S 90/14
Stretch heavy	Sweater knits, fleece, etc.	Medium weight threads: <ul style="list-style-type: none"> • normal cotton or polyester sewing thread • rayon embroidery thread 	Stretch 130/705H-S 90/14
Leather	Suede and leather	Medium weight threads: <ul style="list-style-type: none"> • normal cotton or polyester sewing thread • rayon embroidery thread 	Stretch 130/705H-S 90/14
Vinyl	Vinyl, faux leather and suede	Medium weight threads: <ul style="list-style-type: none"> • normal cotton or polyester sewing thread • rayon embroidery thread 	Universal 130/705H 80/12

Note: Specialty fabrics and threads may require a special needle for best stitch results. Refer to your HUSQVARNA® VIKING® retailer for more information on needle types and sizes for your sewing needs.

Threading for Twin Needle

Replace the sewing needle with a twin needle. Make sure that the presser foot and needle are in the up position.

1. Raise the main and the auxiliary spool pins. Slide on a large spool cap and a thread spool to the main spool pin. Slide on a large spool cap and a thread spool to the auxiliary spool pin.
2. Hold both threads with two hands as illustrated. Floss the threads under the thread guide (A) from front to back. Pull threads together back into and through threading slot.
3. Place one of the threads from right to left under the thread guide on the pre-tension disc, place the other thread directly into the pre-tension discs (B).

Note: Continue to hold the threads lightly next to the thread guide (A) throughout the threading process. This will create a bit of tension on the threads and ensure that the threads are properly seated in the threading path.

4. Pull the threads between the thread tension discs (C). Make sure that you place one thread to the left and one to the right side of the tension discs.

Thread down through the right threading slot and then upwards through the left threading slot. Bring the threads from the right into the take-up lever (D) until they click into place (E), and down in the left threading slot (F). Place both threads inside the needle thread guide (G). Make sure the threads do not become twisted together.

5. Thread the twin needle manually.

Note: The weight and irregular surface of specialty threads such as metallic increases the amount of friction on the thread. By reducing the tension, the risk of needle breakage and thread breakage is reduced.

Tip: When using larger thread cones, use the optional Mega Spool Stand, and place both threads in the telescope.

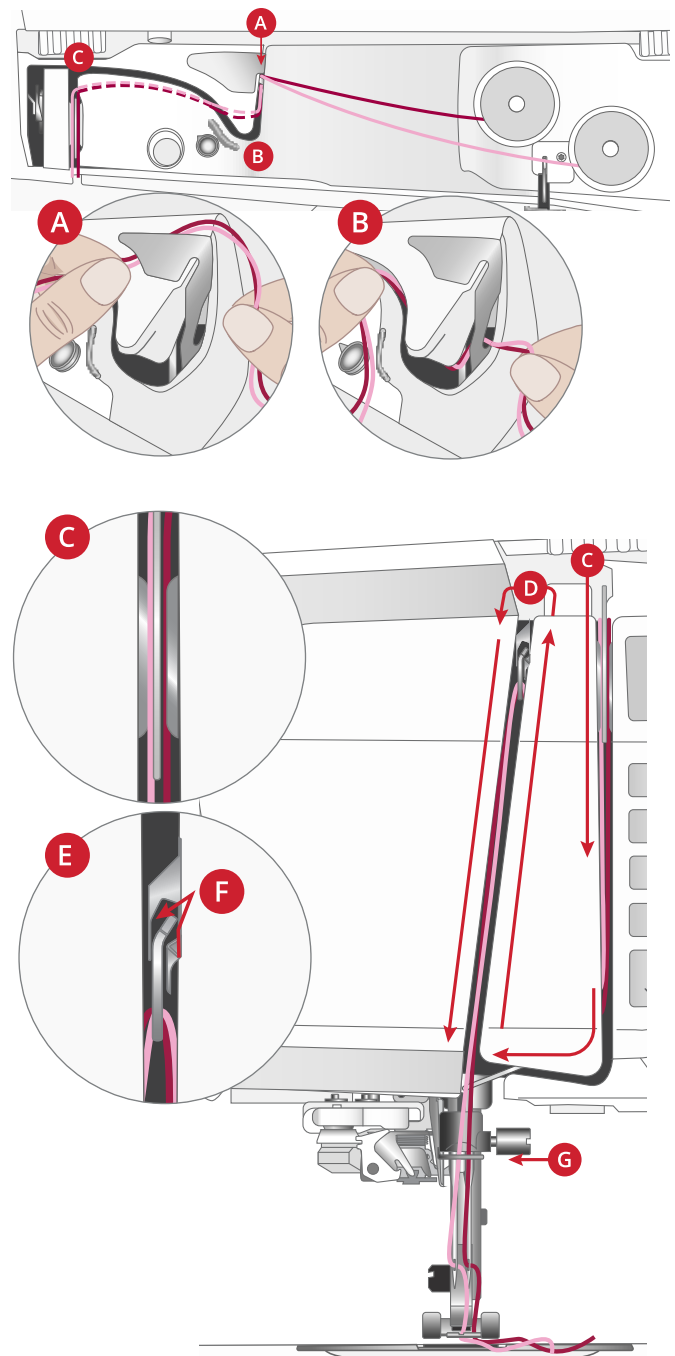

Threading Tips and Hints

There are many threads on the market today developed for different purposes. The quality and structure of the thread as well as the shape and size of the thread spool can affect the behavior of the thread. Threads can also behave differently if the spool is full or nearly empty.

Note: Always test sew on a scrap piece of fabric to check the sewing result.

If the thread is of a quality that unwinds easily and slides down on the standing thread spool it can get caught under the thread spool around the spool pin and break. Place the large spool holder on the spool pin with the flat side up before placing the thread spool.

If the thread spool has the same diameter as the large spool holder, place a thread net as illustrated from below over the spool before placing it on the spool pin.

Note: To prevent snagging or increased thread tension on the thread, the thread net should cover the lower part of the thread spool only, not the top where the thread spool narrows.

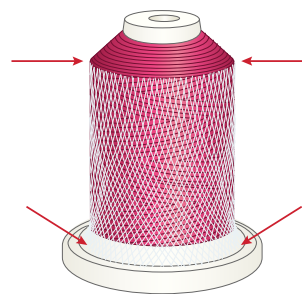

Bobbin Winding

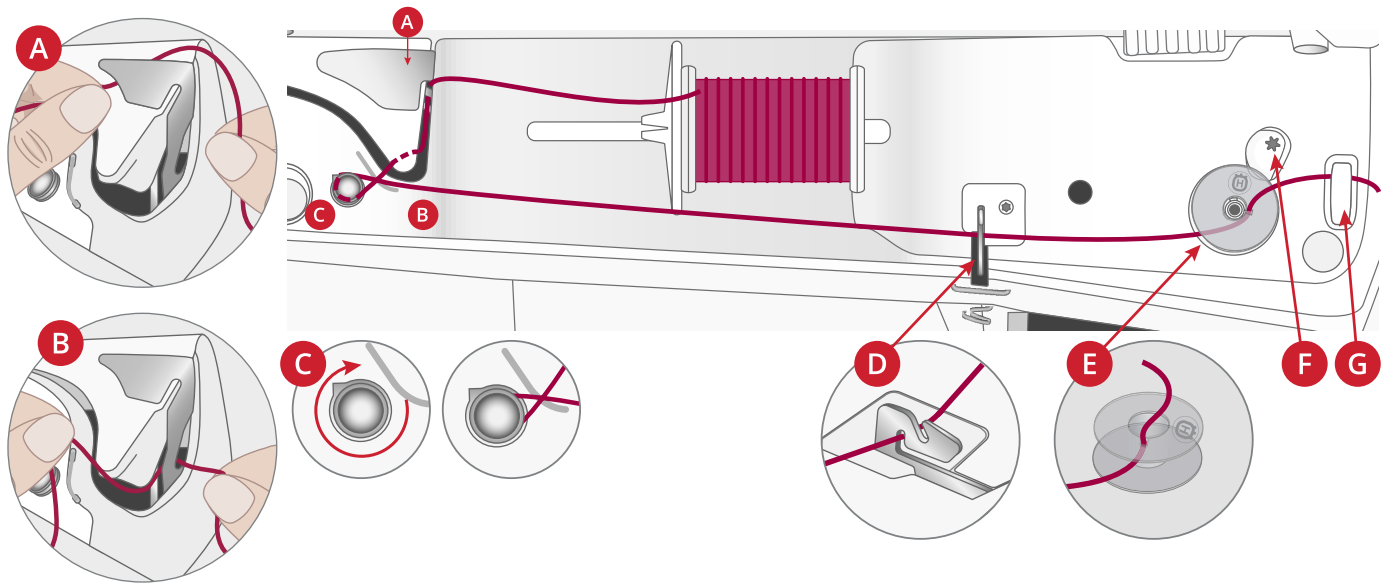

Note: Always wind specialty threads at lower speed.

1. Place the thread spool on the main spool pin and fit a spool cap of the right size.
2. Hold the thread with two hands as illustrated. Floss the thread under the thread guide (A) from back to front. Pull thread back into and through threading slot as shown (B).
3. Bring the thread clockwise through the bobbin winding thread tension guide (C).
4. Bring the thread through the bobbin winding thread guide (D) as illustrated.
5. Thread through the slot in the bobbin (E) from the inside to the outside.

Place the bobbin on the bobbin spindle. The bobbin only fits on one way, with the logo facing out.



The bobbins included are designed especially for your Topaz™ 55Q machine. Do not use bobbins from other machine models.

6. Push the bobbin winding lever (F) towards the bobbin. A pop-up appears on screen. To adjust winding speed drag the slider. Hold the thread end firmly when starting to wind. Touch the play button in the popup window and let the thread wind a few turns. Touch the pause icon and cut the loose thread end close to the bobbin. Press play again.
7. When the bobbin is full, the bobbin winding lever will move back and the winding will stop automatically. The pop-up message closes. Remove the bobbin and cut the thread using the bobbin winding thread cutter (G).

Bobbin Winding using the Auxiliary Spool Pin

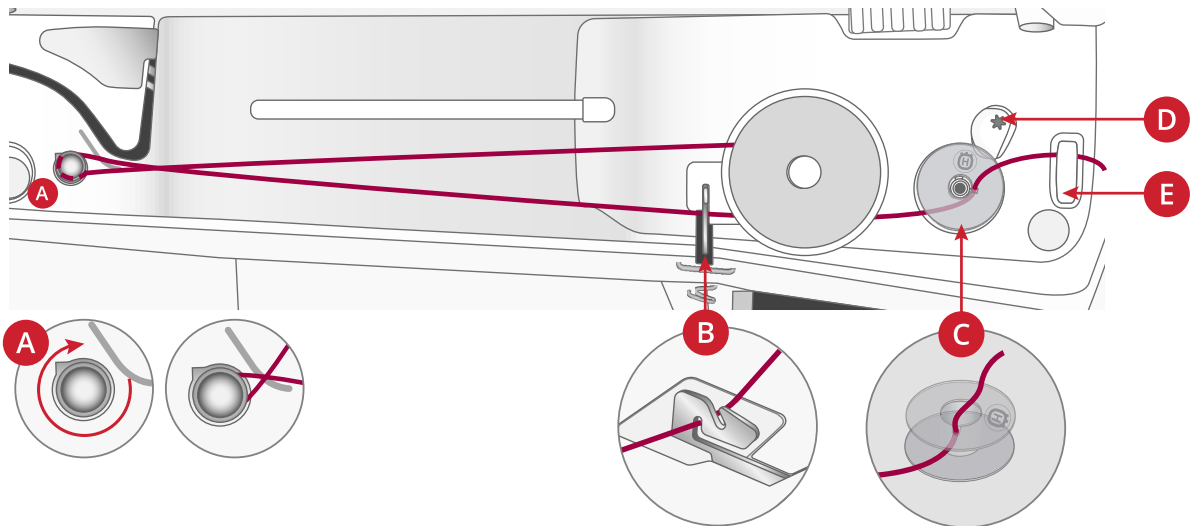

Use the auxiliary spool pin to wind if your machine is already threaded and you want to wind from another spool of thread.

1. Insert the auxiliary spool pin in the hole at the top of the sewing machine.

Place a spool cap and a felt pad under the spool, then place the thread spool on the spool pin.

2. Bring the thread clockwise through the bobbin winding thread tension guide (A).
3. Bring the thread through the bobbin winding thread guide (B) as illustrated.
4. Thread through the slot in the bobbin (C) from the inside to the outside.

Place the bobbin on the bobbin spindle. The bobbin only fits on one way, with the logo facing out.



The bobbins included are designed especially for your Topaz™ 55Q machine. Do not use bobbins from other machine models.

5. Push the bobbin winding lever (D) towards the bobbin. A pop-up appears on screen. To adjust winding speed drag the slider. Hold the thread end firmly when starting to wind. Touch the play button in the popup window and let the thread wind a few turns. Touch the pause icon and cut the loose thread end close to the bobbin. Press play again.
6. When the bobbin is full, the bobbin winding lever will move back and the winding will stop automatically. The pop-up message closes. Remove the bobbin and cut the thread using the bobbin winding thread cutter (E).

Bobbin Winding Through the Needle

When using the same thread in the needle and bobbin, it is convenient to wind a new bobbin directly through the needle without having to unthread/re-thread your machine.



We do not recommend winding speciality threads such as invisible or other stretchy threads, metallic or flat metallic threads through the needle. Very heavy and coarse threads should not be wound through the needle either as the thread tension can become too high, causing the needle to break. Wind specialty threads as described under Bobbin Winding, page 38.

1. Make sure that the presser foot and needle are in the up position.
2. Thread the machine as described under Threading the Upper Thread, page 33.
3. Pull the thread from the needle, under the presser foot and up to the right.

Note: Always use a metal presser foot when bobbin winding from the needle.

4. Use both hands to bring the thread through bobbin winding thread guide (A), up through the threading slot and from left to right through thread guide (B).
5. Thread through the slot in the bobbin (C) from the inside to the outside.

Place the bobbin on the bobbin spindle. The bobbin only fits on one way, with the logo facing out.



The bobbins included are designed especially for your Topaz™ 55Q machine. Do not use bobbins from other machine models.

6. Push the bobbin winding lever (D) towards the bobbin. A pop-up appears on screen. To adjust winding speed drag the slider. Hold the thread end firmly when starting to wind. Touch the play button in the popup window and let the thread wind a few turns. Touch the pause icon and cut the loose thread end close to the bobbin. Press play again.
7. When the bobbin is full, the bobbin winding lever will move back and the winding will stop automatically. The pop-up message closes. Remove the bobbin and cut the thread using the bobbin winding thread cutter (E). Cut the free thread end close to the bobbin.

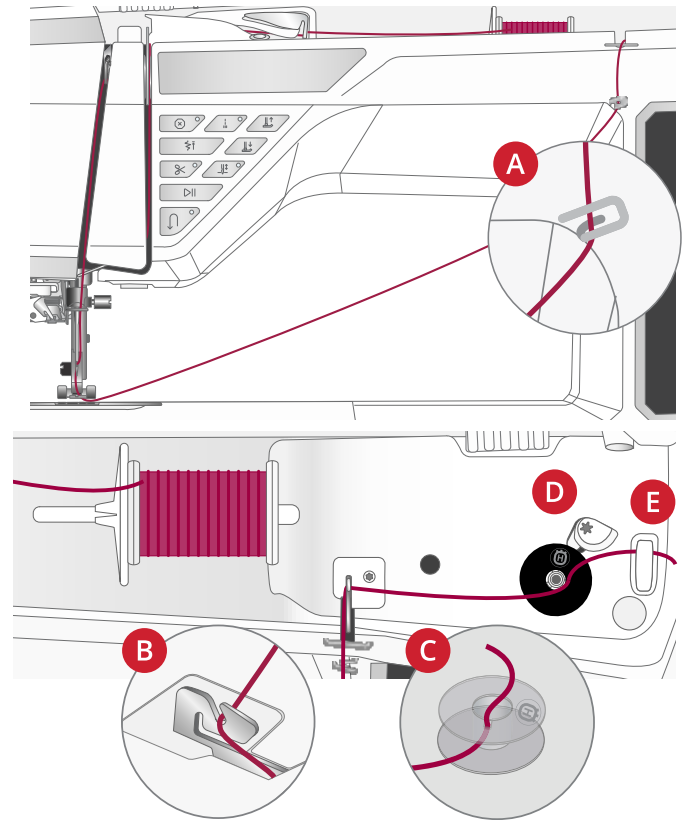

Inserting the Bobbin



Use only the bobbins designed for your Topaz™ 55Q machine.

1. Remove the bobbin cover by pushing it towards you (A).
2. Place the bobbin in the bobbin case. It drops in only one way with the logo facing up. The bobbin will then rotate counterclockwise when you pull the thread.
3. Place your finger on the bobbin to keep it from turning as you pull the thread firmly to the right and then to the left into the tension spring (B) until it “clicks” into place. Continue threading around (C) and to the right of the thread cutter (D).
4. Replace the bobbin cover. Pull the thread to the left to cut.

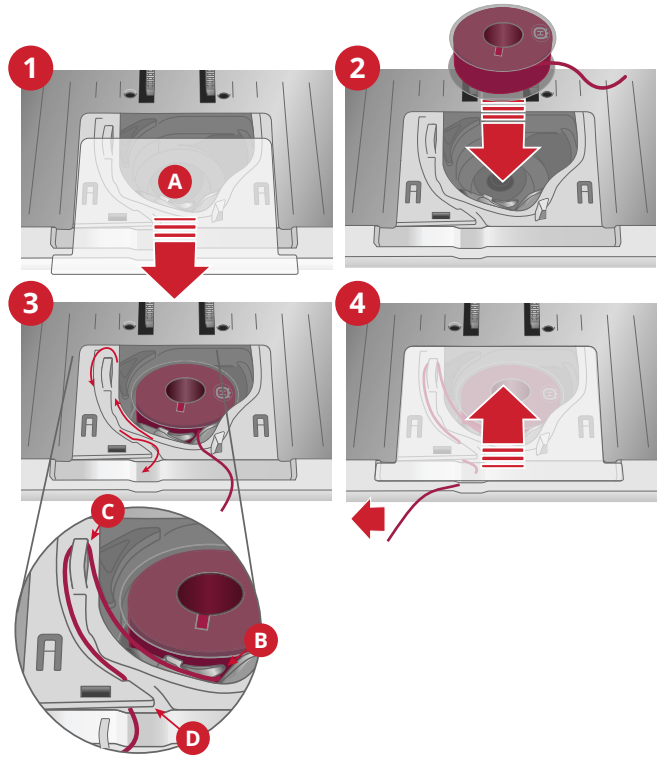

Changing the Presser Foot

1. Make sure that the needle is in the highest position. Pull the presser foot down and towards you.
2. Line up the cross pin on the foot with the gap in the presser foot ankle. Push the foot into the gap until the foot snaps into place.

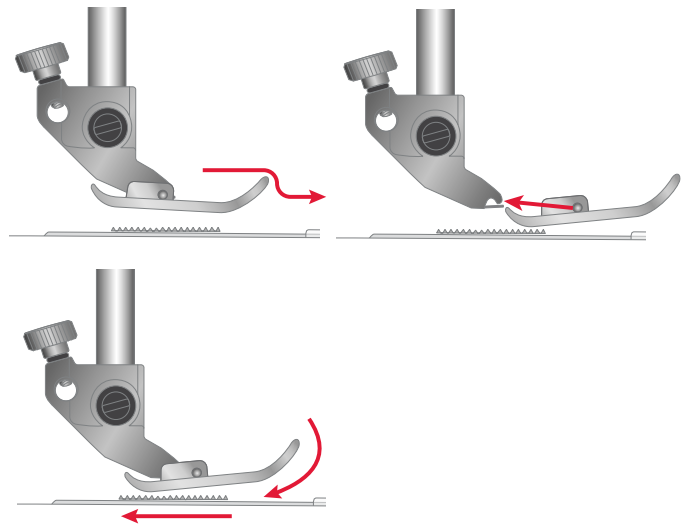

Connect the Sensor One-Step Buttonhole Foot

1. Snap on the Sensor One-Step Buttonhole Foot.
2. Insert the plug, with the three dots facing out, into the accessory socket at the back of the sewing head.



Before using the automatic needle threader with the Sensor One-Step Buttonhole Foot attached, lift the wheel of the foot up to avoid damage to the needle threader and foot.

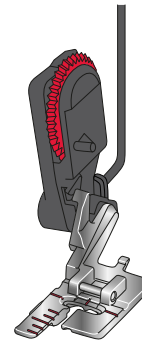
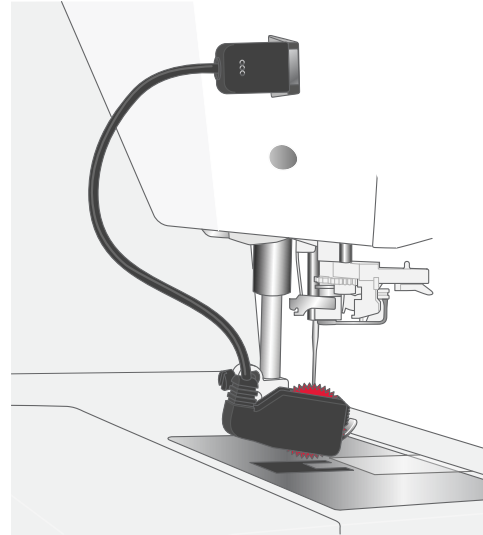

Getting Started with WiFi and CREATIVATE

Connect to a Network with WiFi

Touch the WiFi button. Select from the list of available networks. If your network is password protected, you will be prompted to enter the password to connect.



WiFi icon

Connect to CREATIVATE Services

When you have established a WiFi connection, touch the CREATIVATE icon and sign in to your account. If you do not have a CREATIVATE account, you can easily create one, visit CREATIVATE.com for more information.



CREATIVATE icon

3 The Multi-Touch Screen

Main Functions

Images may look different than your screen and/or machine depending on what machine model and color settings you have. All functionality has been verified to be accurate for this model.

Home

The home screen is shown every time you start your Topaz™ 55Q machine. The home screen is always accessible through the home button.



CREATIVATE™ Services

With empowering design tools and intuitive software for every skill level, CREATIVATE gives you the magic touch on all your projects. Go to CREATIVATE.com to become a free Basic Member today.



JoyOS ADVISOR™

This is where you will find tutorials in sewing, quilting as well as learn more about your machine, accessories, recommended needles and stabilizers.

User's Guide

Here you will find information about how to operate your Topaz™ 55Q machine and what the different features of the machine are.



You can look through the user's guide using the table of contents or sorted by an alphabetical index.

Save

Touch to save your stitch or sequence at anytime.



Quick Help

On almost every function and icon on screen, you can get a short description by using the quick help function.

Touch the question mark icon. Then touch an icon or an area on the screen you want information about.

Some quick helps will refer to the user's guide for more information.



Common Functions

The following functions on the screen are used frequently.

OK

Confirms changes and pop-up messages and returns to previous window.



Cancel

Cancels changes and pop-up messages and returns to previous window.



Touch & Hold

Some buttons have additional functions, marked with an arrow at the lower right corner. To access those functions, touch & hold on the icon for a few seconds.



Smart Toolbox

The smart toolbox is available in the sewing area. Touch & hold anywhere in your work area to open the smart toolbox and select the option you want.

The options included in the smart toolbox differ depending on where they are used. For example; duplicate, delete, mirroring and edit.

Customize Your Work Area

The Topaz™ 55Q allows you to access the functions you use the most by arranging them as you desire on the screen.

Touch & hold the move icon in the center until the control pop's up. Drag and drop it to desired location. Your machine will remember your changes when turning your machine off. Touch the x to close the control. To reset the toolbar to default, use smart toolbox and select reset toolbar.



Move

Top Bar

Several functions are accessible on the top bar, for example CREATIVATE, home button, quick help, and settings.

Note: All functions may not always be available at the same time.



1. *User's guide*
2. *Project viewer*
3. *CREATIVATE services*
4. *Home*
5. *Clock*
6. *Quick help*
7. *Update available*
8. *WiFi*
9. *Settings*

Secondary Top Bar

In the secondary top bar you will see recommendations for your selected stitch, see which features that are currently active, as well as information such as stitch name and speed.

You can expand and collapse by clicking the arrow. Then you will see the full name of all the icons.

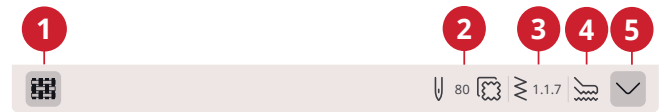

1. *Fabric selection*
2. *Recommendations*
3. *Information*
4. *Active features*
5. *Extended secondary top bar*

Fabric Selection

Select the fabric that you will use. The stitches loaded will be set to fit your selected fabric.

Recommendations

Here you find recommendations for the selected stitch regarding presser foot, needle type/size, and if stabilizer should be used.

Information

Shows for example the selected stitch. It also shows the speed setting for selected stitch.

Active Features

This section shows activated features, such as tie-off options, needle down or changes you have made in settings.

4 WiFi & CREATIVATE Services

WiFi Introduction

Your Topaz™ 55Q machine features WiFi, which makes it possible to connect your machine wireless to the CREATIVATE services.

Getting Started With WiFi

Touch the WiFi button and activate WiFi. Select a network from the list of available networks. If your network is password protected, you will be prompted to enter the password to be able to connect.

Touch the settings icon to see more settings for the network. You can also see the signal strength and if the network is password protected, indicated with a closed padlock.

You can also connect to a network with WiFi in [WiFi Settings](#).

If you do not get any signal or have a low signal strength see [Troubleshooting](#).



- A. WiFi is disconnected. Connect to a network through WiFi button or [WiFi settings](#).
- B. WiFi is connected with low signal strength.
- C. WiFi is connected with medium signal strength.
- D. WiFi is connected with high signal strength.
- E. WiFi is connected but the network does not work properly.

Firmware Updates

Firmware Update Using WiFi

It is always recommended that you install the latest firmware in your machine.

To be able to get the latest firmware you need to connect to a network using WiFi. When connected, your machine will automatically search for an available firmware update. If the machine has detected that there is a newer firmware available, the firmware update icon will be visible. Touch the icon to download and install the latest firmware.

When the update is completed the machine will restart automatically. Check the firmware version number in settings, [Machine Information](#).



Indication that your machine does not have the latest firmware and that an update is available.

Firmware Update Using a USB Device

Visit the HUSQVARNA® VIKING® website and find your machine. Here you will find the available updates.

1. Download the update firmware zip file. Unzip the file and copy the file (.clo) to a USB device.

Note: Do not change the name of the file or do not copy the file into an existing folder on the USB device.

Note: Make sure that there is no old firmware update file (.clo) on the USB stick when copying the new firmware update file (.clo). The file name is not unique.

2. Make sure that the machine is turned off. Connect the USB device loaded with the new firmware version to a USB port on your machine.
3. Press and hold the [reverse button](#), located on the front of the machine, and turn on your machine with the ON/OFF button. Release the reverse button when an update icon is shown on the screen.
4. The firmware update will be verified and installed. The machine may restart several times during the update process. Do not turn off the machine.
5. When the update is completed the machine will restart automatically. Check the software version number in settings, [Machine Information](#).

CREATIVATE Services

With empowering design tools and intuitive software for every skill level, CREATIVATE gives you the magic touch on all your projects. Go to [CREATIVATE.com](https://creativate.com) to become a free Basic Member today.



CREATIVATE

Design Catalog

Browse thousands of ready-made designs and assets including complete projects with easy-to-follow, step-by-step instructions.

CREATIVATE Blog

In CREATIVATE blog you can view the latest product news, sewing instructions and get inspiration!

The machine needs to be connected to WiFi to be able to see the feed.

CREATIVATE App

You can download the app for free to your mobile device. Visit [CREATIVATE.com](https://creativate.com) to learn more. You can download directly in your App Store of choice.



- A. *Signed in to CREATIVATE*
- B. *Synchronizing files with CREATIVATE.*
- C. *Not signed in to CREATIVATE*

5 Home Screen

Home Screen— Overview

The home screen is filled with guidance, inspiration and help, making sure that you get the assistance you need in order to utilize your machine's full potential.

Here you'll find the JoyOS ADVISOR™ feature, which includes a large amount of different tutorials to choose from.

If you're in need of inspiration on what to create, read the CREATIVATE blog, which is updated frequently.

Read your user's guide directly on screen for instant help.

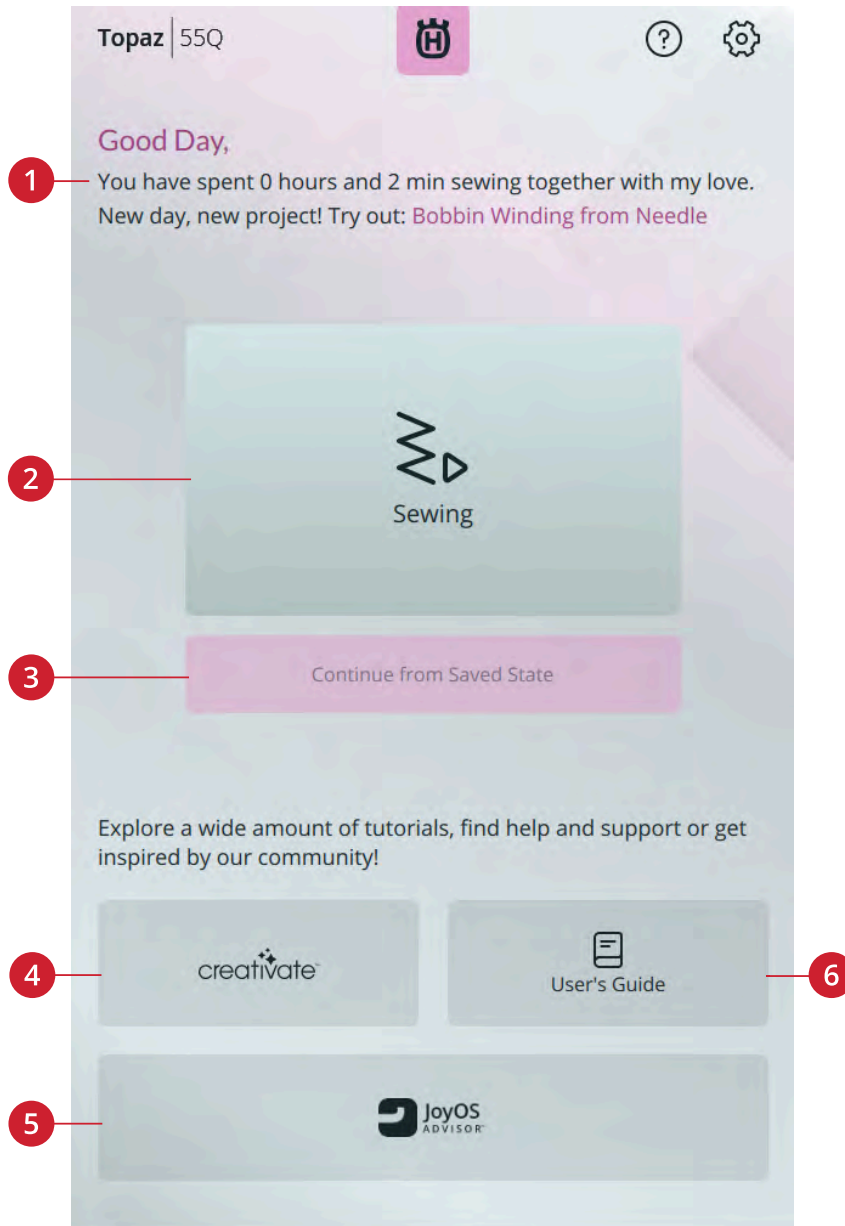

- 1. [User profile](#)
- 2. Sewing — start new session
- 3. Continue from saved state
- 4. CREATIVATE
- 5. JoyOS ADVISOR™
- 6. User's guide

Edit Machine Nickname

On your home screen you can see the name of your machine.

This can be useful when owning more than one machine to distinguish one machine from another.

You can change your machine's nickname in settings.

User Profile

When you are signed in to your CREATIVATE account, your user name will be shown. You will receive information on, for example, how much time you've spent sewing on your machine.

Start New Session

Click here if you want to go to sewing mode directly.

Continue from Saved State

When saving current state, all your adjustments are stored and you can continue later by touching "continue from saved state".

Note: You can only have one current state saved at a time.

CREATIVATE

In CREATIVATE blog you can view the latest product news, sewing instructions and get inspiration!

The machine needs to be connected to WiFi to be able to see the feed.



User's Guide

Here you will find information about how to operate your Topaz™ 55Q machine and what the different features of the machine are.

You can look through the user's guide using the table of contents or sorted by an alphabetical index.



JoyOS ADVISOR™

You have a large amount of different tutorials to choose from, which step-by-step will guide you through text, illustrations and animations.

You can learn a lot of different techniques within sewing and quilting. If you need help with the basics of your machine, for example how to; thread the machine or wind the bobbin, there are tutorials for that as well. You can even find tutorials on how to use your accessories.

Select your fabric type and choose from a wide selection of available sewing techniques. The JoyOS ADVISOR™ feature will instantly set the best stitch, stitch width, stitch length and presser foot pressure for the technique you've chosen.

Use the search function to search within the JoyOS ADVISOR™.

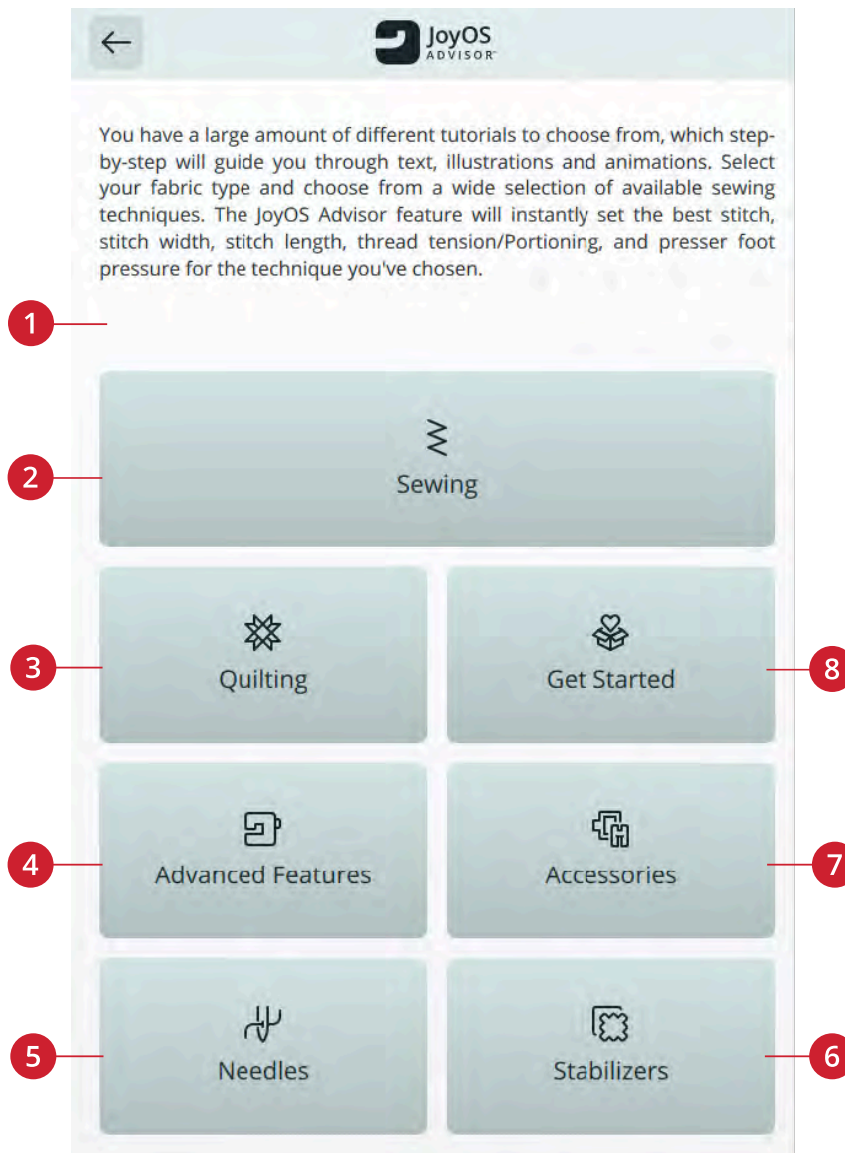

- | | | |
|----------------------|----------------|----------------|
| 1. Search | 4. Needles | 7. Get started |
| 2. Sewing | 5. Stabilizers | 8. Quilting |
| 3. Advanced features | 6. Accessories | |

Sewing

When loading a sewing technique the machine will select the best stitch and settings for your chosen fabric and project.

Depending on which choices you make, your JoyOS ADVISOR™ feature will recommend the most suitable sewing techniques.



Fabric Selection

Start your sewing by selecting the fabric that you will use.

After selecting a fabric, touch a sewing technique group and the JoyOS ADVISOR™ feature will recommend sewing techniques suitable for your fabric.

Suggested fabrics for each fabric group you can choose from are listed below.

Note: Some fabrics have excess dye which can cause discoloration on other fabrics or on your sewing machine. This discoloration may be very difficult or impossible to remove.

Fleece and denim fabric, especially red and blue, often contain excess dye.

If you suspect that your fabric/ ready-to-wear garment contains a lot of excess dye, always pre-wash it before sewing/ embroidering to prevent discoloration of your machine.

Woven or Knit

The difference between woven and knit fabric is the way the threads are put together. Woven fabrics are made of two thread system, warp lengthwise and weft crosswise, that intersect at right angles. A knit fabric is made of one thread system with interlaced stitches. A knit fabric usually has stretch.

As a general rule, select woven in the JoyOS ADVISOR™ feature for stable fabrics that have no stretch and stretch for fabric that have stretch.

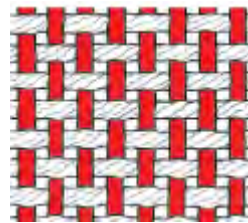

Woven fabric

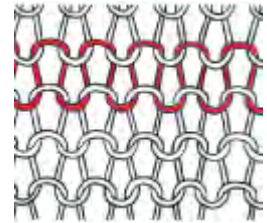

Knit fabric

Woven Fabrics

Woven Light: Chiffon, organza, batiste, challis, crepe de chine etc.

Woven Medium: Calico, quilting fabrics, crepe, broadcloth, velvet etc.

Woven Heavy: Denim, tweed, canvas, terrycloth etc.

Stretch Fabrics

Stretch Light: Tricot, single knit jerseys etc.

Stretch Medium: Sweater knits, double knit, velour, swimwear etc.

Stretch Heavy: Sweater knits, fleece etc.

Leather and Vinyl

For suede and leather. Leather is animal skin with the coat (fur) removed. Leather can be smooth or sueded and has some give.

For vinyl, faux leather and suede. Vinyl is a synthetic material which often has a woven wrong side. Vinyl can be smooth or patterned and some vinyls have stretch.

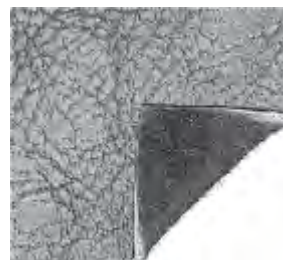

Leather fabric



Vinyl fabric

Get Started

In this section you will find help that has to do with the basics of the machine such as threading the machine.



Advanced Features

Your machine has a lot of great features which enables you to create unique stitches and sequences, shape your texts and much more.

All tutorials in this category will walk you through all of these features included in your machine.



Accessories

There is a wide assortment of HUSQVARNA® VIKING® accessories that are compatible with your machine.

The tutorials in this category will show how to use accessories both for sewing and quilting.



Needles

In this category you can read more about all the different types of HUSQVARNA® VIKING® needles that you can choose from.



Stabilizers

When embroidering, the use of a stabilizer is necessary. HUSQVARNA® VIKING® offers a selection of different types of stabilizers, depending on your need.

In this category you can find information about all available stabilizers in our assortment and when they are recommended to be used.

- **Cut-a-Way:** Cut-a-Way stabilizers are stabilizers that need to be cut away by using scissors. It will stay on the fabric to make the embroidery more stable.
- **Batting:** Use batting between your top fabric and backing to add body to your project.
- **Water soluble stabilizer:** The stabilizers in this category are stabilizers that dissolves in water. They are very useful when embroidering lace and cutwork embroideries.
- **Specialty:** In this category you will find stabilizers for special uses.
- **Tear-a-Away:** Tear-a-way stabilizers are temporary stabilizers. They are easy to remove after embroidering



Project Viewer

When loading a tutorial from JoyOS ADVISOR™ it will be shown in the project viewer.

In the project viewer you can change the fabric that you will use. The stitches loaded through the project are set to fit your selected fabric.

You can enlarge the images shown by touching it.

Load the recommended stitch for the loaded technique by touching the stitch in the viewer.

In every tutorial, content such as stitches and embroideries, are filtered out based on the chosen technique.

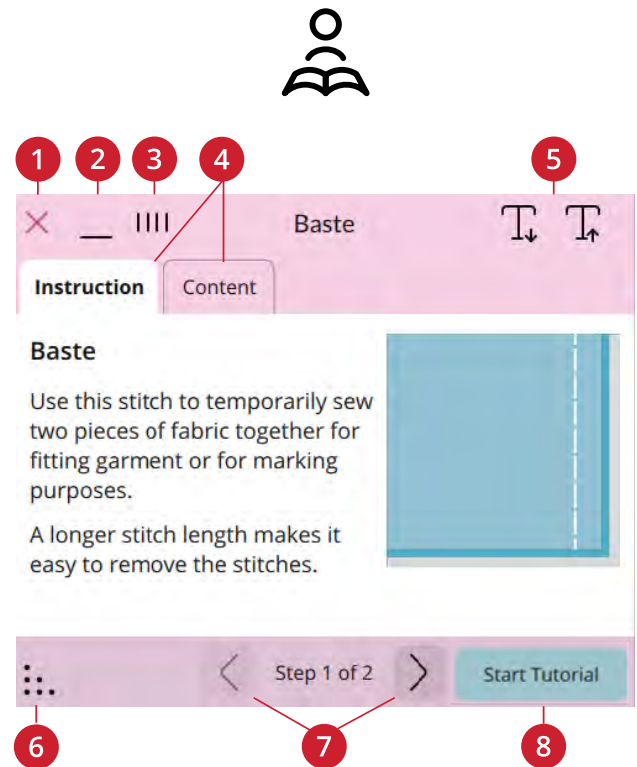

- | | |
|-------------------------------|---------------------------------------|
| 1. <i>Cancel</i> | 5. <i>Decrease/increase text size</i> |
| 2. <i>Minimize</i> | 6. <i>Expand</i> |
| 3. <i>Detach/move</i> | 7. <i>Step backward/forward</i> |
| 4. <i>Instruction/content</i> | 8. <i>Start tutorial</i> |

How to Play Animations

In the video player you can pause, rewind, fast forward, set the animation on repeat and turn full screen mode on/off. Touch cancel to close the video player. Touch & hold on rewind to start the animation from the beginning.

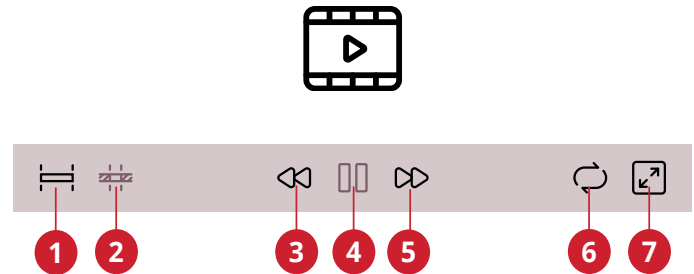

- | | |
|--|------------------------------|
| 1. <i>Watch full animation</i> | 5. <i>Fast forward</i> |
| 2. <i>Watch clip</i> | 6. <i>Repeat on/off</i> |
| 3. <i>Rewind (touch & hold to go to beginning)</i> | 7. <i>Full screen on/off</i> |
| 4. <i>Play/pause</i> | |

6 Sewing

Sewing Mode – Overview

In sewing mode you can select stitches, adjust and sew them. Your selected stitch will be shown in actual size in the stitch field. You will see active features and be given recommendations based on selected stitch.

Note: All symbols and options will not be shown at the same time.

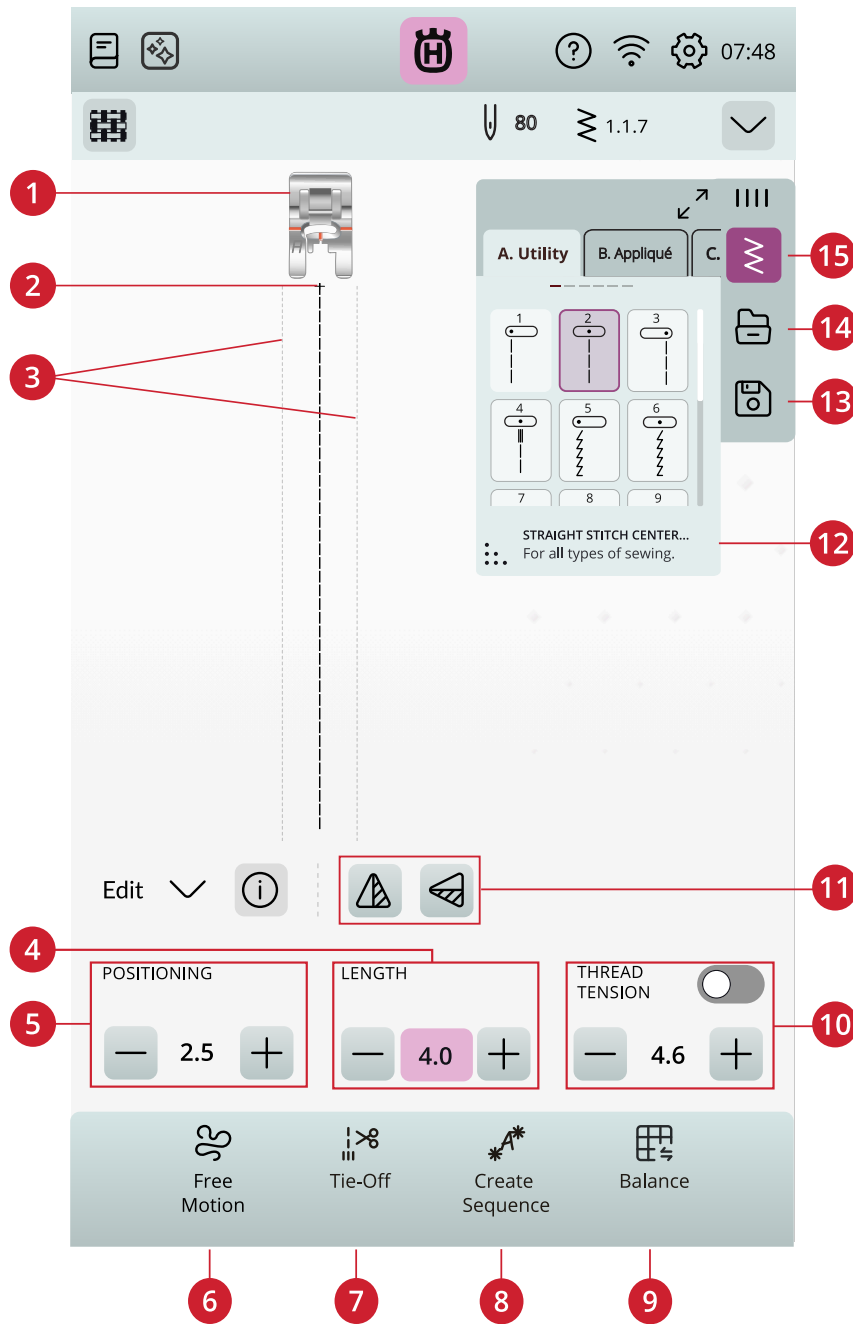

- | | | |
|------------------------------------|--|---|
| 1. Recommended presser foot | 7. Tie-off options | 11. Mirror side to side/mirror end to end |
| 2. Stitch start | 8. Create sequence | 12. Stitch information |
| 3. Maximum stitch width indication | 9. Balance | 13. Save |
| 4. Stitch length/stitch density | 10. Thread tension/presser foot pressure | 14. File manager |
| 5. Stitch width/stitch positioning | | 15. Stitch menu |
| 6. Free-motion options | | |

Load a Stitch

Touch the stitch menu and select the desired stitch. Available stitch categories are listed horizontally, swipe to see more categories. All categories have sub categories. When you select a stitch, it will automatically be loaded and you get a short description of the selected stitch. The select stitch window can be expanded if you touch and drag the triangle in the lower corner.

From the file manager you can load stitches or sequences that you have saved in your Vault folder or on a USB device. In file manager you will see all your saved files e.g. stitches, designs and fonts. Learn how to organize your files in [file manager](#).

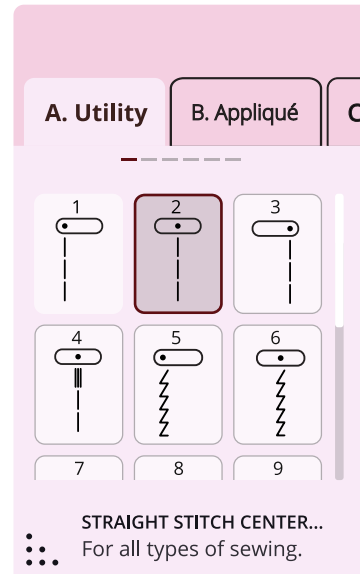

Information and Sewing Recommendations

Recommendations are shown in the secondary top bar. Your machine automatically gives you recommendations depending on the selected stitch and current setting.

Stitch Settings

Your machine will set the recommended settings for each selected stitch. You can make your own adjustments to the selected stitch. The changes will only affect the selected stitch and will be reset to default when selecting another stitch or turning your machine off. To save your adjusted stitch, touch [save](#).

The controls available on the screen will change depending on what stitch or sequence is loaded. Some stitches have more than one control, and an alternative switch bar will appear. Touch the alternative switch bar to change to an alternative control for a different stitch setting. Touch it again to change back to the previous control. The different stitch settings are described below.

If you need an explanation of the icons, touch the drop down arrow to open a panel with description of the icons.

Note: When trying to exceed minimum or maximum settings for width and length, a warning sound will be heard. The default setting is always shown in black numbers.

Stitch Width

Decrease or increase the stitch width using – and + in the control. The number shows stitch width in mm/inch.

Changed stitch position may limit the stitch width adjustments.



Example of stitch setting control

Stitch Positioning

On certain stitches with a width less than 7 mm it is possible to change the stitch position. Use – to move the stitch to the left and + to move the stitch to the right. The number shows the needle start position in mm in relation to center needle position. The machine has a maximum of 29 needle positions (for a straight stitch).

The stitch position can only be changed to the limit of the maximum stitch width. Changing the stitch positioning will also limit the stitch width adjustments.

Stitch Length

Decrease or increase the stitch length using – and + in the control. The number shows the set stitch length in mm/inch. If lengthening a zigzag stitch or a decorative stitch, the entire stitch will be stretched out. If lengthening a stitch where the density can be adjusted, the entire stitch will be longer but the density of the satin stitches will remain the same.

Stitch Density

The stitch density control adjusts the density (the distance between the individual satin stitches that make the entire stitch). The density does not affect the actual length of the entire stitch.

Touch – to decrease the density. Touch + to increase the density. The number shows the distance between satin stitches in mm/inch.

Tip: Decrease the density to get different visual effects e.g. when using speciality threads.

Mirroring

To mirror a stitch or stitch sequence sideways, touch mirror side to side. To mirror a stitch or stitch sequence lengthwise, touch mirror end to end.

Tip: Use the [smart toolbox](#) to open a shortcut for mirroring.

Note: Some stitches e.g. buttonholes cannot be mirrored.



Mirror side to side/mirror end to end

Buttonhole Slit Length

Set the buttonhole slit length by using - to decrease and + to increase when sewing a buttonhole with the Sensor One-Step Buttonhole Foot.

Button Stitch Repetition

When sewing a button, you can set the number of stitch repeats. Use the – or + in the control to decrease or increase the number of stitch repeats.

Presser Foot Pressure

Touch + to increase or - to decrease the pressure of the presser foot on the fabric.

In most cases, you do not need to adjust the presser foot pressure. Specialty techniques may require an adjustment. The higher the number the more pressure on the fabric.

EXCLUSIVE SENSOR SYSTEM™

Thanks to the EXCLUSIVE SENSOR SYSTEM™ feature, the presser foot automatically and continuously senses and adjusts as you sew any thickness of fabric for perfect even feeding.

Go to sewing mode to see the actual setting of the sensor foot pressure for the selected fabric and adjust the presser foot pressure.

Balance

When sewing on special fabrics or doing a special technique, the balance may need to be adjusted.

Start by sewing the stitch on a piece of scrap fabric. Touch the balance icon. Change the preview on the screen to match your sewn sample by using the + and - in the controls. When you sew again, the balance will be corrected.



Balance

Free Motion Options

All stitches on your machine can be sewn in free-motion to create unique effects.

Choose between different free-motion options.

For all free-motion sewing the feed teeth needs to be lowered manually and the fabric must be moved manually.

When sewing free motion with a straight stitch, use the optional straight stitch plate for best result.

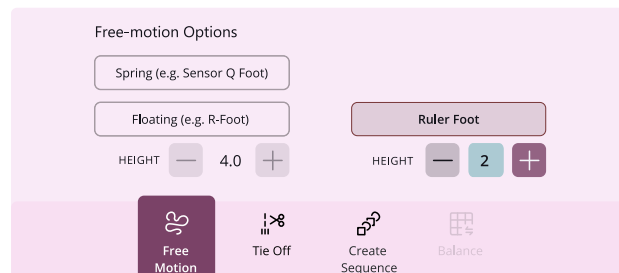

Free Motion Spring

Select free motion spring to use spring feet, e.g. the Sensor Q-Foot. Lower the feed teeth manually.

A spring foot will raise and lower with each stitch to hold the fabric on the needle plate while the stitch is being formed.

When sewing, you need to move the fabric manually.

Tip: The Sensor Q-Foot and an optional open toe free motion spring foot can be purchased at your local authorized retailer.

Free Motion Ruler Foot (Optional)

Select free motion ruler foot to use the optional free motion ruler foot. Lower the feed teeth manually.

The presser foot floats over the fabric while sewing.

To adjust the presser foot height, touch the presser foot height control to make adjustments.

Free Motion Floating

Select free motion floating to use floating feet, e.g. the R-Foot. Lower the feed teeth manually.

When sewing at low speed the presser foot will raise and lower with each stitch to hold the fabric on the needle plate while the stitch is being formed. At higher speed, the presser foot floats over the fabric while sewing. The fabric must be moved manually.

Skipped stitches can occur if your fabric moves up and down with the needle as you are stitching. Lowering the presser foot height will reduce the space between the presser foot and the fabric and eliminate the skipped stitches.

Note: Be careful not to reduce the presser foot height too much. The fabric must still move freely under the presser foot.

To adjust the presser foot height in free motion floating mode, touch the presser foot height control to make adjustments.

Note: If free motion floating is activated, do not use a spring action foot, as this might damage the presser foot.

Note: Activate stitch width safety if the presser foot requires it.

Tip: There are optional free motion floating feet that can be purchased at your local authorized retailer.

Tie-Off Options

These options allow you program tie-off at the beginning and at the end of a stitch. It is also possible to program thread cut at the end of a stitch.

When touching the tie-off icon, three options open to let you select different functions; tie-off beginning, tie-off end and thread cut.

Your settings are shown under active features.

Note: For immediate tie-off, use the tie-off button, found on the front of the machine.



Sewing with Tie-Off Options selected

- The tie-off beginning will be performed as soon as you start to sew.
- Press the stop button to perform tie-off end. The action indicator lamp will be lit to indicate that the machine will finish the stitch and do the tie-off.
- When a thread cut is programmed, the machine will automatically cut the threads after performing a stitch. The needle and presser foot will raise.



Tie-off beginning/ tie-off end

Save Stitch

You can choose to save your file to the Vault folder or to a USB device (only visible as a selection when an USB device is connected). Previously saved designs, stitches, sequences and/or fonts are shown.

Read about organizing your saved stitches in [File Manager](#).

When saving current state, adjustments are stored and you can continue later by touching “Continue from Saved State” at the home screen.

Note: You can only have one current state saved at a time.



Save button

Sewing Techniques

In JoyOS ADVISOR™ you can find all tutorials for the sewing techniques mentioned below.

In basic sewing techniques you will find the most commonly used sewing techniques.

Seam

A seam sews two pieces of fabric together with a seam allowance that will usually be pressed open. In most cases, edges of the seam allowance are finished with an overcast stitch before sewing the seam.

Seams in stretch fabric must stretch with the fabric. The stretch stitch makes a stretchy seam that is suitable for sewing together pieces of light stretch fabric.

Your JoyOS ADVISOR™ feature will select the best stitch length and stitch width for the fabric weight and recommend the presser foot and needle.

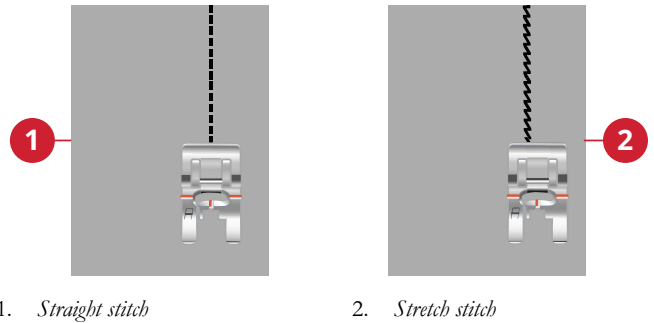

Overcast

Overcast fabric edges to prevent fraying and to help them lay flat. It is easier to overcast before the garment is sewn together.

Your JoyOS ADVISOR™ feature will select the best stitch length and stitch width for the fabric weight and recommend the presser foot and needle.

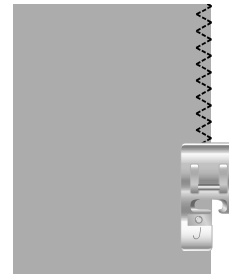

Seam and Overcast

The seam/overcast stitch sews the seam and overcasts the edges all at one time. The seam/overcast technique is perfect for stitching ribbed neckbands and cuffs. There are a number of different seam/overcast stitches in your machine.

Your JoyOS ADVISOR™ feature will select the best one for your fabric and make all adjustments automatically and recommend the presser foot and needle.

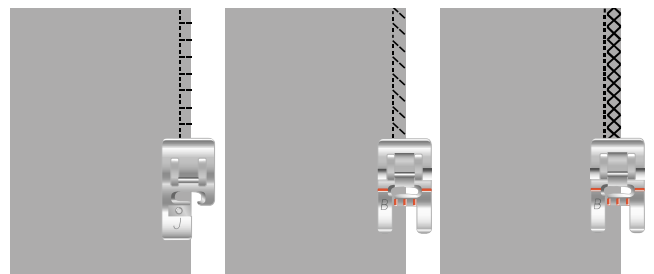

Baste

Basting is temporary stitching for fitting garments, gathering and marking. The JoyOS ADVISOR™ feature automatically sets a long stitch length and reduces the tension so the threads are easy to remove or to pull for gathering.



Blind Hem

The blind hem creates an invisible hem on garments. There are two types of blind hems; one is recommended for medium to heavy fabrics, the other for stretch. The blind hem is not suggested for light weight fabric, leather and vinyl.

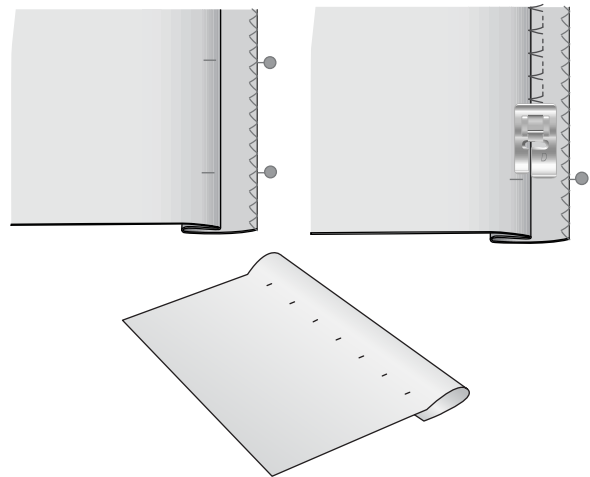

Hem

The hem technique on your JoyOS ADVISOR™ feature will select the visible or topstitch hem that is best for your fabric weight and type. For woven fabric, leather and vinyl a straight stitch is selected. For stretch fabrics, stitches that can stretch are selected.

Buttonholes

The JoyOS ADVISOR™ feature will select the best buttonhole and stitch settings for your chosen fabric. Fabric should be interfaced and/or stabilized where buttonholes are to be sewn.

Sew a test buttonhole on a fabric scrap to verify the desired length of the buttonhole.

Measure the desired distance from the fabric edge and then add the length of your buttonhole.

When sewing, place the finished fabric edge with stabilizer underneath the presser foot, facing away from you.

Use the marking on your fabric to position the starting point.

Manual Buttonhole

Manual buttonholes are recommended for woven heavy fabric. To sew a manual buttonhole, use the [buttonhole foot C](#).

1. Sew the first column as long as you want the buttonhole to be.
2. Touch the [reverse button](#). The machine sews the bartack and the second column.
3. When the columns are aligned, touch the [reverse button](#) to sew the second bartack.

You can use the repeat buttonhole icon to sew identical copies. The repeat buttonhole icon is only visible when sewing a buttonhole manually. Deselect to cancel the function.

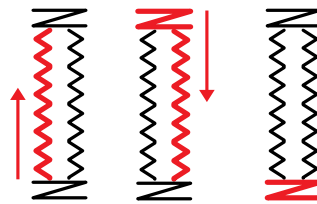

Sewing direction for buttonholes without satin stitches or satin stitch buttonholes sewn with presser foot C.

Automatic Buttonhole

When sewing buttonholes on woven light, woven medium, stretch light or vinyl fabric you can use the [Sensor One-Step Buttonhole Foot](#). The Sensor One-Step Buttonhole Foot will sew automatic buttonholes. Read about how to [attach the Sensor One-Step Buttonhole Foot](#).

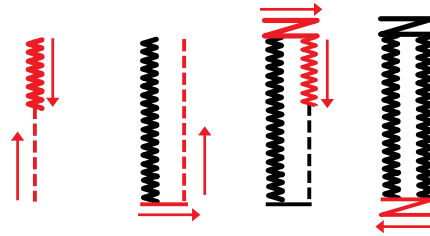

Sewing direction for satin stitch buttonholes sewn with the Sensor One-Step Buttonhole Foot.

Corded Buttonhole

Corded buttonholes are recommended when sewing buttonholes on stretch medium or stretch heavy fabric. Use gimp threads for a more stable durable and professional appearance. Use pearl cotton or a regular gimp thread. Attach the [buttonhole foot C](#) and use the finger on the back of the foot for holding the cord when sewing.

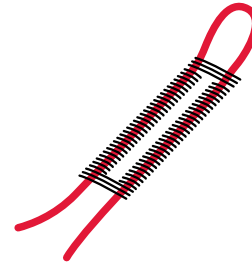

Programmable Button Sew On

Sew buttons, snaps, hooks and eyes quickly with your machine. Select sew on button in the JoyOS ADVISOR™ feature.

When sewing a button, you can set the number of stitch repeats. Use the – or + in the control to decrease or increase the number of stitch repeats.

Note: Place the thin end of the multipurpose tool under the button when sewing on light fabrics. Use the thick end for heavier fabrics. Hold in place on the fabric with transparent tape.

Note: The recommended width of 3.0 is set for most buttons. If you sew a tiny button or a very large coat button, decrease (–) or increase (+) the stitch width until the swing of the needle sews in the holes of the button or snap.

Note: An optional button foot for sewing on buttons can be purchased at your local authorized dealer.

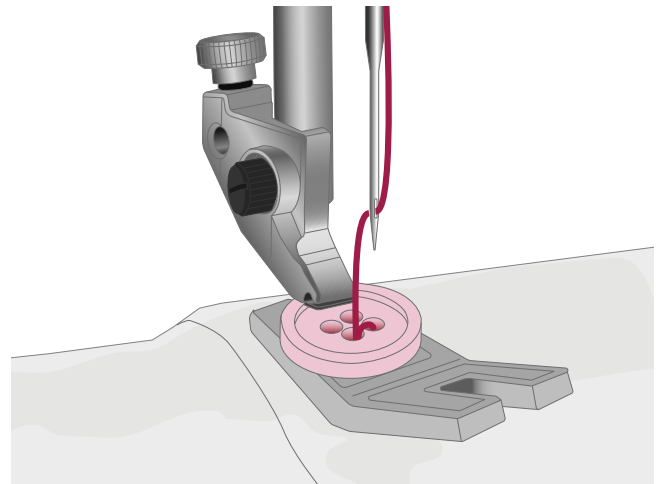

Tapering Stitches

The tapering menu will be visible when a stitch from the tapering stitches menu is selected. Touch the tapering menu to select from different angles for beginning and end tapers. The machine will sew the beginning tapered point and then continue with the selected stitch. When the desired length has been sewn, touch the reverse button. The stitch will taper to the end.

Select taper “off” to remove any tapering at the beginning or end of the stitch. If you select taper “off” on both the beginning and end, the stitch will be a regular stitch without tapering.



Special Stitches For Optional Presser Feet

Includes special stitches like candelwicking and edge stitches. These techniques may require special presser feet and accessories. This is indicated by the optional presser foot icon on the screen.

Tip: Detailed information on the current selected stitch is shown in the stitch information.

Exclusive Sewing Techniques

Theme Stitches

Theme stitches are beautiful combined stitches, in a group of four, designed to be sewn out together in a random combination. Touch the reverse button on the front of your machine or the reverse button on the screen to change to the next stitch in the group. If you touch the reverse button twice – quickly – you will skip the next stitch in the group.

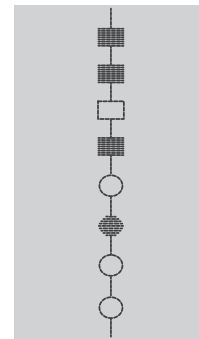

Example of theme stitch



Reverse button on the screen

Embellished Stitches

Embellished stitches are decorative stitches where you can change the appearance of the stitch after it is sewn for a special effect. These stitches can be decorated with crystals or cut for a tassel effect.

Tassel stitches are sewn with many threads on top of each other. The threads can either be left as they are sewn or cut to create a 3D effect. The long stitches should be cut at the very edge and from the top side of the fabric. To make the cutting easy, use a seam ripper.

Tip: For heavier threads, use the optional Specialty Candlewicking Foot for easier feeding.

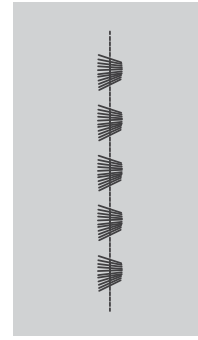

Example of tassel stitch

Pop-up Messages in Sewing

To make your sewing experience as convenient as possible, your machine will sometimes communicate with you using pop-up messages. Those messages can contain warnings, recommendations, information or prompt you to perform an action.

Below, some of the messages that can appear are listed and explained.

Bobbin Thread Low

When the bobbin thread is running low, a pop-up message appears giving you notice that you will soon need to replace the bobbin. If you want to continue sewing without replacing the bobbin, touch the foot control and do not close the pop-up.

When the bobbin is replaced with a full one, touch OK in the pop-up.

Stitch Width Safety

When stitch width safety is activated, the following pop-up message appears when you choose a stitch not suitable for stitch width safety.

Cannot Use the Automatic Needle Threader

If using a twin needle, touch OK and thread it manually. If using a regular needle, touch OK and deselect twin needle in the settings. Press the automatic needle threader button again.

Remove Sensor One-Step Buttonhole Foot

The Sensor One-Step Buttonhole Foot needs to be removed before doing any of the following:

- Sewing a stitch that is not a buttonhole.
- Sewing a buttonhole that can not be sewn with the Sensor One-Step Buttonhole Foot.
- Sewing an adjusted buttonhole saved without the Sensor One-Step Buttonhole Foot in the CREATIVATE folder.

Check Upper Thread

The machine stops automatically if the upper thread runs out or breaks. Re-thread the upper thread, close the pop-up message and start sewing.

Attention!

If the machine stops and this pop-up appears on the screen you need to stop sewing. Wait a moment and touch OK when it is enabled. Check the needle size and condition. Check for correct threading.

Twin Needle

The following pop-up message appears when you choose a stitch not suitable for twin needle.

7 Sequence

Sequence – Overview

In sequence, you can create and adjust a sequence of stitches. Combine various 7mm stitches, and stitch fonts from the machine, Vault or from a USB device. Stitches made in Topaz™ 55Q feature can also be inserted in a sequence. You can create sequences up to approximately 500mm (20") long. You can see how long your actual sequence is in the information area.



Touch to open Sequence

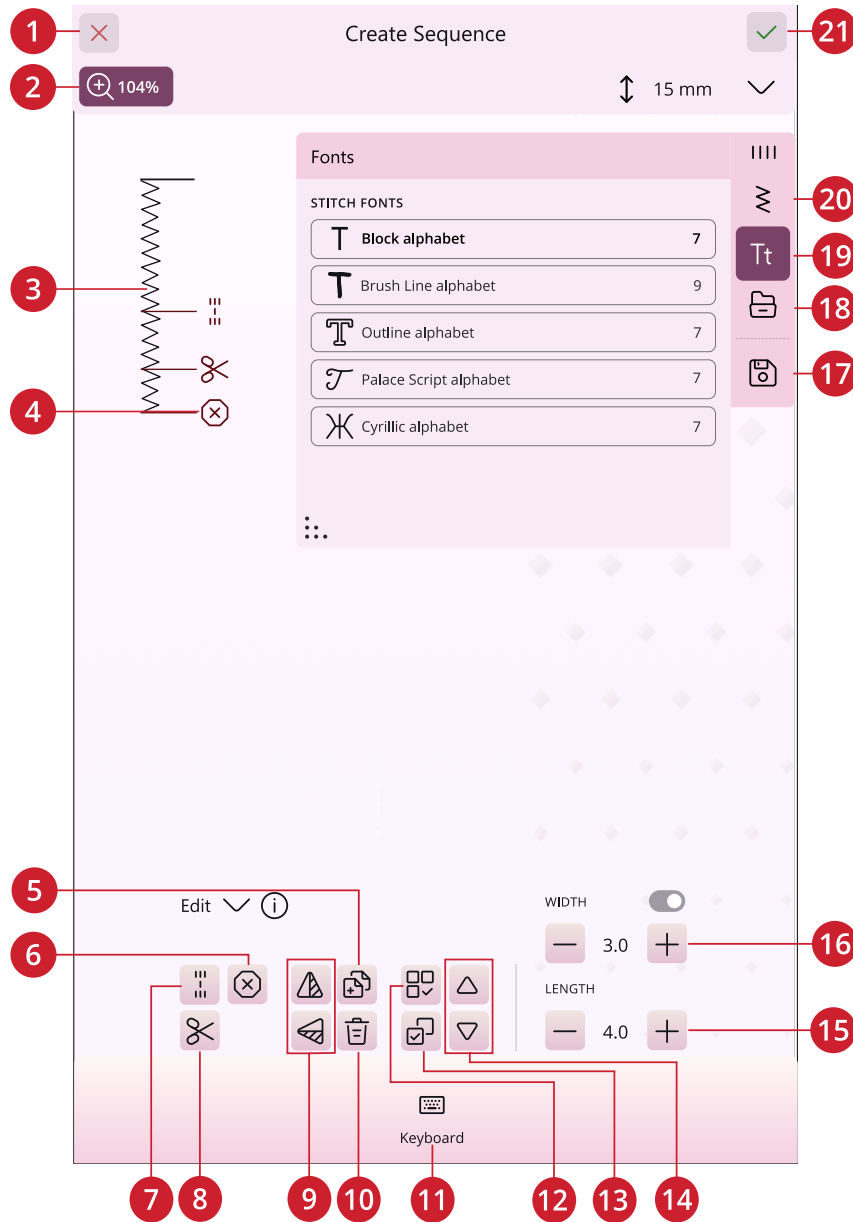

- | | | |
|----------------------------|--|-------------------------------------|
| 1. Cancel | 9. Mirror side to side/mirror end to end | 16. Stitch width/stitch positioning |
| 2. Zoom options | 10. Delete | 17. Save |
| 3. Sequence in actual size | 11. Keyboard | 18. File manager |
| 4. Inserted commands | 12. Select all | 19. Font menu |
| 5. Duplicate | 13. Select multiple | 20. Stitch menu |
| 6. Stop command | 14. Step between stitches | 21. OK |
| 7. Tie-off command | 15. Stitch length/stitch density | |
| 8. Thread cut command | | |

Getting Started with Sequence

To start creating a sequence, select a desired stitch and/or letter and add it to the sequence. The active position is marked by a cursor and the selected stitch or letter will be highlighted. Only the selected stitch/stitches can be adjusted. Inserted stitches will be placed at the cursor position.

Touch select multiple to select several stitches in a sequence.
Touch select all to select all stitches.

Move the cursor through the sequence using the arrows. The number of selected stitch and total number of stitches in the sequence are shown between the arrows. When sewing a sequence it is possible to start sewing anywhere in the sequence. Use the arrows to step through the sequence.

Note: Buttonholes and 4-way stitches cannot be programmed.

Edit and Adjust Your Sequence

Adjust Stitch Settings

You can adjust the length and width of the stitch or change the density or position of the selected stitch. The adjustments work just like in sewing mode.

Duplicate

To duplicate a stitch, move the cursor to the stitch you want to duplicate. Touch the duplicate icon to copy the selected stitch.

Note: If you make adjustments on the stitch before duplicating, the copied stitch includes the adjustments.

Touch & hold to get a pop-up where you can enter the exact number of copies you want to insert.

Delete

If you want to delete a stitch or letter, touch the stitch or move the cursor to the stitch or letter you want to delete and touch delete. Touch & hold to delete the whole sequence.

Sequence Commands

You can insert tie-off, stop and thread cut commands into the sequence. These commands will be included in the sequence and will always be performed when sewing it.

Use the tie-off command if you want a secure tie-off. You can insert the tie-off commands anywhere in the sequence.

Insert a stop command if you want the machine to stop. This is useful for example at the end of the sequence if you want to sew it only once or to create a sequence in several rows.

Insert a thread cut command if you want the machine to tie-off and cut the threads and raise the presser foot.

Move the cursor to the position where you want to add a command. Select it and an icon will be added into the sequence. This confirms that the command is inserted and it also shows where the command will be performed in the sequence.

Note: The commands will appear on the screen in the order you program them.

Saving a Sequence

To save your file, touch save. You can choose to save the file to the Vault folder or to a USB device. Previously saved stitches, sequences and/or fonts are shown.

Learn how to organize your saved files in [File Manager](#).



Save button

Sew Your Sequence

To sew your stitch sequence, load it to sewing mode by touching OK in sequence.

Adjust the Entire Sequence

To adjust the entire sequence, enter sewing mode by touching OK. Adjustments made in sewing mode will affect the entire sequence. Read about [edit stitch](#).

Using Sequence in Sewing Mode

In sewing mode it is possible to start sewing anywhere in the sequence. Use the arrows to step through the sequence. In sewing mode you can edit your entire sequence.

If you are in sewing mode and want to edit a stitch in the sequence, touch “edit in sequence” and the stitch will open in sequence. Make your adjustments and touch OK to load it to sewing mode again. Touch cancel to undo.

Note: Touch and hold in the stitch field area to open the smart toolbox to access edit in sequence.

Pop-up Messages in Sequence

To make your sewing experience as convenient as possible, your machine sometimes communicates with you using pop-up messages. Those messages can contain warnings, recommendations, information or prompt you to perform an action.

Below, some of the messages that can appear are listed and explained.

Stitch Cannot be Added in Sequence

Some stitches are not possible to insert in a stitch sequence, for example buttonholes and special stitch menus such as 4-way stitches.

Maximum Number of Stitches Has Been Reached

The stitch you are trying to add will make the stitch sequence too long. Your stitch sequence can be up to approximately 500 mm (20”) long and contain up to 199 stitches and commands. If the stitch sequence exceeds the maximum length this pop-up message will appear.

8 Settings

Sewing Settings

Automatic Presser Foot Lift

When selected, the machine automatically raises the presser foot in the following situations:

- When stopping with the needle in the down position the presser foot will automatically raise to pivot height.
- After a thread cut the presser foot will be raised to lift position.

When deselected, the presser foot will stay lowered, even if the machine stops with the needle in down position.

Automatic Thread Cutter

When selected, the threads are cut automatically in the following situations:

- At cut commands in stitches and sequences.
- After sewing a single stitch e.g. a monogram or eyelets.

If deselected, no automatic thread cut will be performed.

Note: Deselect when using optional accessories that are attached in the two holes in the needle plate just above the bobbin cover, to prevent damage to the automatic thread cutter knife located under the needle plate.

Stitch Limiting Options

Set the machine to stitch width safety or select the size of the twin needle to limit the stitch width and stitch positioning. This will minimize the risk of breaking a needle when sewing with accessories that do not allow the use of the entire stitch width.

Needle Stop Position

When up is selected your machine stops with the needle up. When down is selected your machine stops with the needle down.

This setting can also be set by touching the needle up/down button on the front of the machine.

Presser Foot Pressure

In most cases, you do not need to adjust the presser foot pressure. Specialty techniques may require an adjustment. The higher the number the more pressure on the fabric.

Tie-Off Options

These options let you program a tie-off at the beginning and at the end of a stitch. It is also possible to program a thread cut at the end of a stitch.

Note: For immediate tie-off, use the tie-off button, found on the front of the machine.

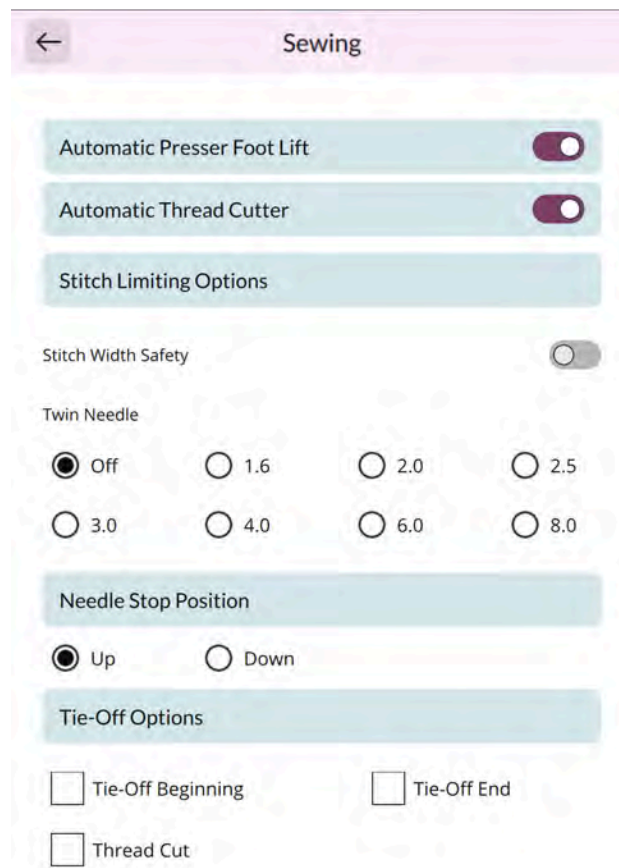

Display & Audio Settings

All settings made in the machine settings will be saved, even when turning your machine off.

Language

Select your desired language. All texts in your machine will be changed after restart.

Time Format

Set if your clock show a 12- or a -24 hour format.

Time Zone

This is where you set your time zone. The clock is set to UTC (Coordinated Universal Time) standards. For example London is UTC time +/- 0 hours, New York is UTC -5 hours and Sydney is UTC +10 hours. Scroll through the time zones to find the time zone you are in.

Timer Functions

You can set an alarm and find a stopwatch.

Machine Usage

Shows the number of hours sewn on the machine since you last reset the timer. You can reset the counter by touching "Reset".

Auto Power Off

Your machine will automatically turn off after a duration of time due to inactivity.

The current state will be saved and possible to restore when the machine is activated again.

You will get a notification before the machine is turned off.

You can change the duration of time before your machine turns off in settings.

Audio Volume

Change the audio volume using the slider bar. All sounds in your machine will be affected when the audio volume is changed. When the slider is all the way to the left, the volume is muted.

Audio Repeat

When active, the signal for some warning alerts or attention pop-up messages will be repeated in intervals until the pop-up is closed.

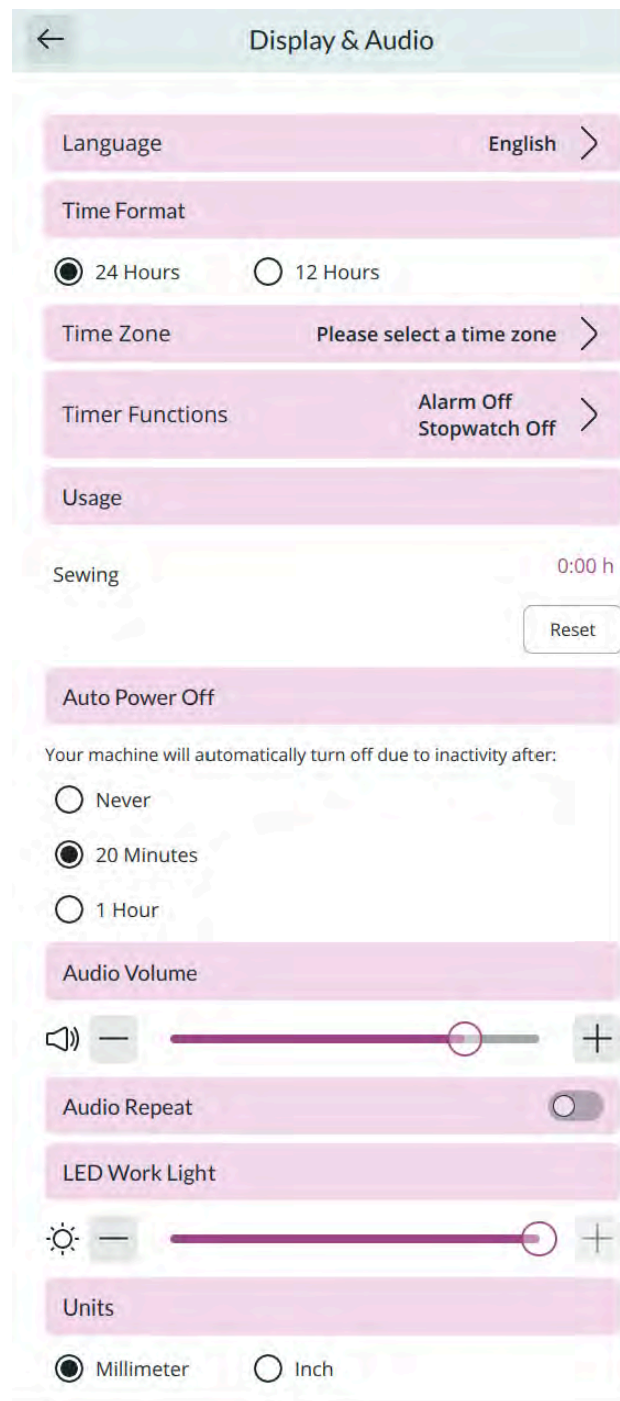

LED Work Light

Adjust the brightness of the LED lights to adapt to the light conditions in your sewing room. Simply move the slider to the right to make the LED lights brighter or to the left to make them less bright.

Units

Touch millimeter or inch to set the measurement unit you prefer.

Personalize Settings

Machine Nickname

Touch to select a nickname for your machine. This can be useful when owning more than one machine, to distinguish one machine from another when working in CREATIVATE.

User Name

Touch to select a user name.

Color Themes

Set your own favorite color theme to your machine.

Bottom Bar Text

Choose whether or not you want to have text together with your icons in the bottom bar.

Customize Your Workspace

Check this box to allow you to move around functions that are used often, and customize them on the screen.

Lock Screen

When selected, the screen is automatically locked whenever it is inactive for ten seconds. A pop-up is shown on the screen and the screen will remain locked until you touch OK in the pop-up.

Always Show Timer in Top Bar

When selected, the timer will always be shown in the top bar.

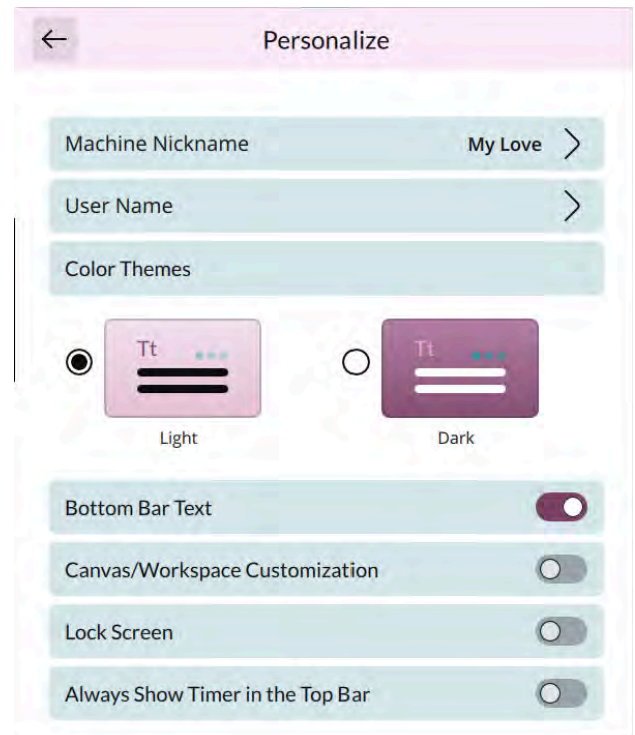

WiFi Settings

In WiFi settings you can activate/deactivate WiFi on your machine, search for available networks and connect. If connected to a network with internet access the latest firmware update will always be available.

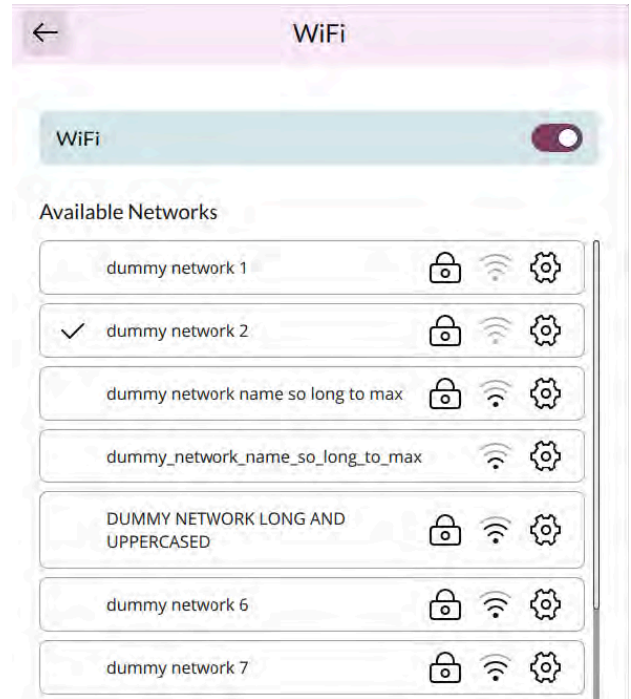

CREATIVATE Settings

In settings you can sign in to your CREATIVATE account. With an account you will be able to access all of the CREATIVATE services.

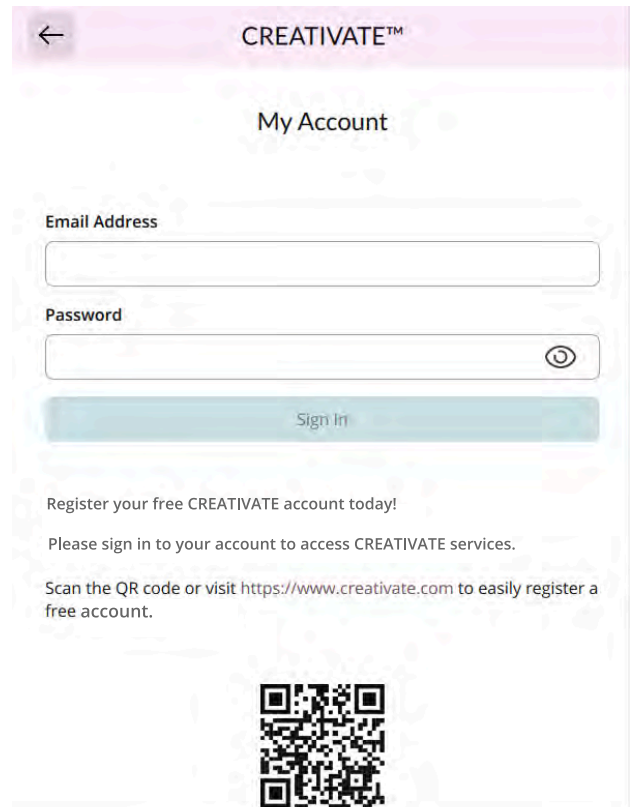

Machine Information

Machine information contains technical machine information such as: machine serial number, machine MAC address and current firmware. In machine information you can clear user account and files.

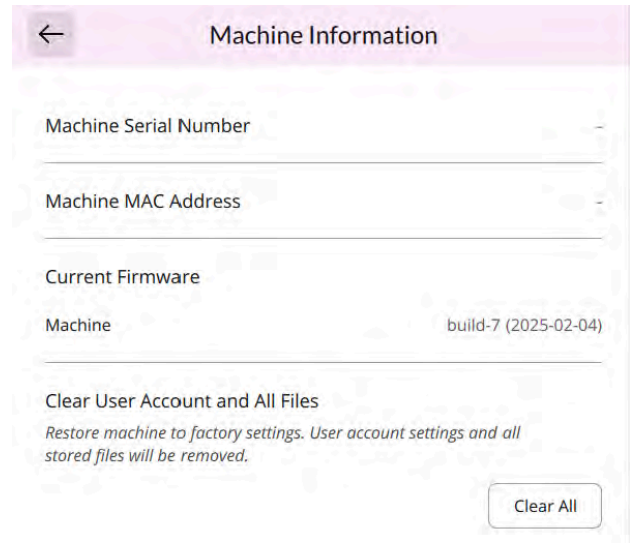

9 File Manager

File Manager – Overview

Touch the folder icon in the Menu Panel to open File Manager.

File Manager is used to open your files. Store your saved files in the Vault folder or to a USB device connected to your Topaz™ 55Q machine.

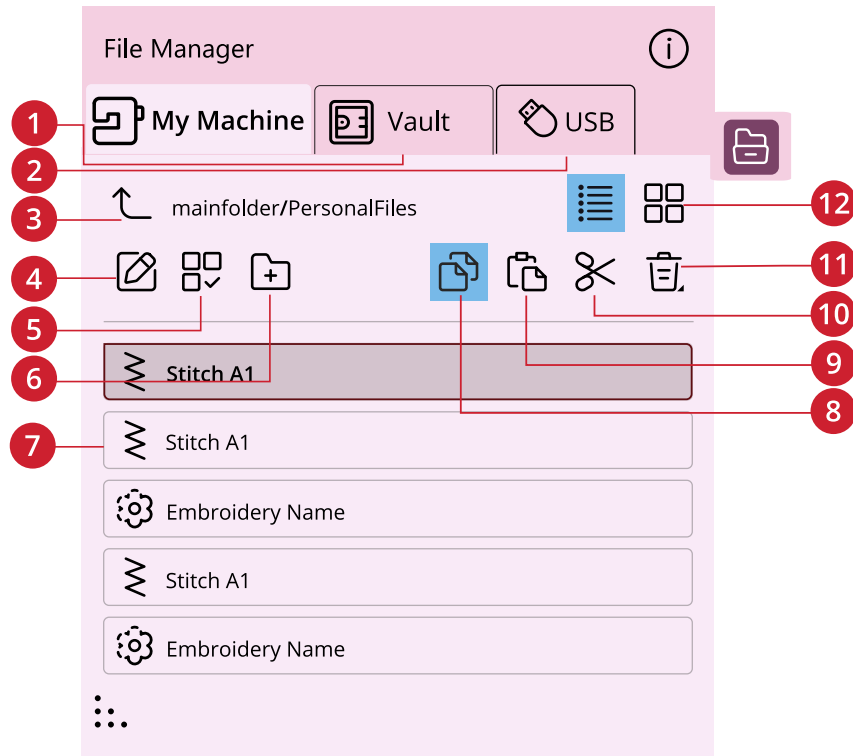

- | | | |
|---------------------------------|-----------------------------|--------------------------------|
| 1. <u>Vault</u> | 5. <u>Select multiple</u> | 9. <u>Paste</u> |
| 2. <u>USB device</u> | 6. <u>Create new folder</u> | 10. <u>Cut</u> |
| 3. <u>Move up one folder</u> | 7. <u>Selection area</u> | 11. <u>Delete</u> |
| 4. <u>Rename file or folder</u> | 8. <u>Copy</u> | 12. <u>List/thumbnail view</u> |

File Formats

Your Topaz™ 55Q machine can load the following file formats:

- .SH7 (stitch file)
- .JOS, .VPP (project files)

Note: If the file type or file version is not supported by your machine, or the file is damaged, it is shown in the selection area as an unrecognized file.

Browse File Manager

Store your files in the Vault folder or to a USB device connected to the USB ports. The USB Device is only available when a USB device is connected to your machine.

To display the content, touch the Vault folder or USB Device. Swipe with your finger upwards and downwards to scroll and view the content. Design files and font files are displayed as thumbnail images or with an icon depending on if you have list view or thumbnail view selected.

Open a File or Folder

Touch a file to read information about the file in the file information area. Touch & hold the file to load it.

If you load a stitch font file, it will be loaded into sequence.

Touch & hold on a folder to open it. The content of the folder will be shown in the selection area.

Select Multiple

If you want to select several files at one time, touch the select multiple icon. While select multiple is activated, touch the files you want to use.



Note: If you try to load a variety of file/folders at the same time that open in different modes/screens, a pop-up message will be shown.

Vault Folder

Save your files to the Vault folder on the machine. Make sure you are signed in to a CREATIVATE account.

USB Device

The USB Device menu is only active when a USB device is connected to the machine. Touch the USB Device menu to display all of the connected devices. Touch a USB Device to explore it.

The files visible in the USB section is listed in File Formats.

Note: If you choose Delete All while in USB, it will delete all the files on your USB, even the ones not visible on the machine.

List/Thumbnail View

Touch the list/thumbnail view icon to toggle between showing the files in a list or as thumbnail icons. In list view each file is shown with the file name and file type. In thumbnail view each file is shown with file name and a thumbnail image of the file.



List view/ thumbnail view

Move up One Folder Level

Use the move up one folder level icon to step up through the levels of folders. You can step up all the way to the first level. In the selection area you will see the files and folders for each level as you step up. Touch & hold on a folder to open it.

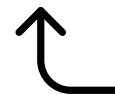

Move up One Folder Level

Organize

Below are instructions on how to organize your files in file manager.

Create New Folder

Touch the create new folder icon to create a new folder in the current position. A pop-up message opens where you can enter a name for your folder.



Create New Folder

Rename a File or Folder

To change the name of a file or folder, touch to select it and then touch the rename file or folder icon. A pop-up message opens where you can enter the new name for a file or folder.



Rename

Move a File or Folder

Use cut and paste to move file(s) or folder(s) to another location.

Select the file(s) or folder(s) and then touch the cut icon. Open the folder where you want to place the selection. Touch the paste icon. The file(s) or folder(s) is removed from its original location and now stored in the new folder.

Note: Activate select multiple to be able to select and move more than one file and/or folder the same time.



Cut



Paste

Copy a File or Folder

Use copy and paste to copy file(s) or folder(s) to another location.

Select the file(s) or folder(s), then touch the copy icon. Open the folder where you want to place the selection. Touch the paste icon. The file(s) or folder(s) is now stored in the new folder and the original file(s) or folder(s) still exists in the previous folder.

Note: Activate select multiple to be able to select and move more than one file and/or folder at the same time.



Copy



Paste

Delete a File or Folder

To delete a file or folder, select it and touch the delete icon. A pop-up message will appear so that you can confirm the deletion. If a folder is deleted, all files within the folder are deleted as well.

To delete all files and folders shown in the active folder, touch & hold the delete icon for a few seconds. A pop-up message will appear so that you can confirm the deletion of all content.

Note: If you choose Delete All while in USB, it will delete all the files on your USB, even the ones not visible on the machine.



Delete

Pop-up Messages in File Manager

To make your experience as convenient as possible, your machine sometimes communicate with you using pop-up messages. Those messages can contain warnings, recommendations, information or prompt you to perform an action.

Below, some of the messages that can appear are listed and explained.

Do You Want to Delete?

When deleting a file or folder, you will need to confirm the deletion in the pop-up message that appears on screen. This will prevent you from deleting anything by mistake.

Not Enough Available Memory

When only a small amount of space is left, your machine will alert you one time. If you continue to fill the space, it will not remind you again, until the space is completely full. Move your files to a USB device by using the cut and paste functions to free up space.

Folder Already Exists

You cannot create a new folder with the same name as another folder on the same level. Create your folder on a different level or enter a different name for the folder.

The Combination of Selected File Types Cannot be Loaded

Some file combinations can not be loaded to the same destination using [select multiple](#).

I0 Maintenance

Cleaning the Machine Exterior

To keep your sewing machine operating well, clean it often. No lubrication (oiling) is needed.

Wipe the exterior surface of your machine with a soft cloth to remove any dust or lint built up.

Wipe the screen with a clean, soft and slightly damp microfiber cloth.

Removing the Needle Plate and Cleaning the Bobbin Area

 *Turn off the machine.*

Remove the presser foot. Remove the bobbin cover. Place the supplied screwdriver under the needle plate as shown and gently turn the screwdriver to pop off the needle plate. Clean the feed teeth with the brush that is included with the accessories.

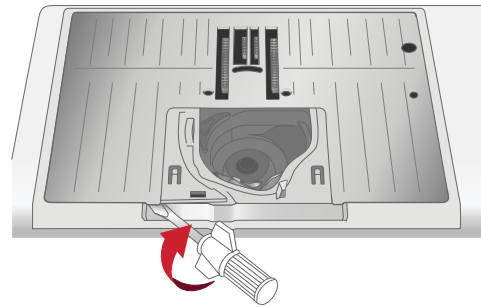

Cleaning Under the Bobbin Area

Clean the area under the bobbin case after sewing several projects or any time you notice an accumulation of lint in the bobbin case area.

Remove the bobbin case holder (A) covering the front part of the bobbin case by lifting it up. Remove the bobbin case (B) by lifting it up. Clean with the brush.

 *Use caution when cleaning around the automatic thread cutter knife (C).*

Put the bobbin case and the bobbin case holder back in place.

Note: Do not blow air into the bobbin case area. The dust and lint will be blown into your machine.

Note: Regularly clean the lint and threads from the bobbin area. Check the area when changing the needle plate.

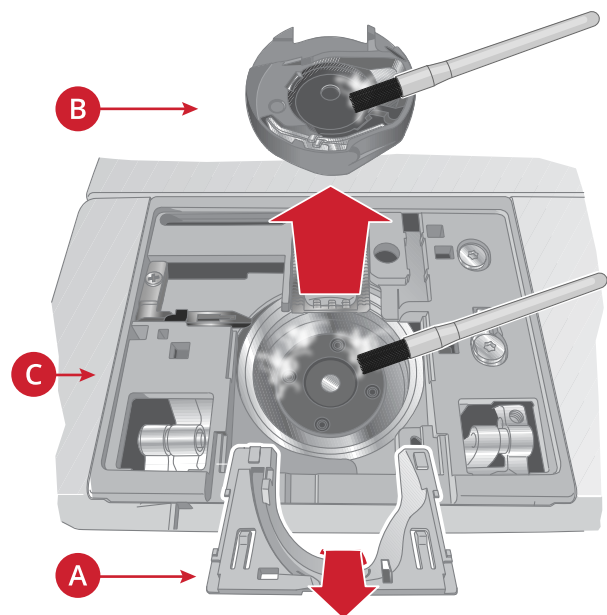

Replacing the Needle Plate

Position the needle plate so that it fits into the notch at the back (A). Press the needle plate down until it clicks into place (B). Replace the bobbin cover.

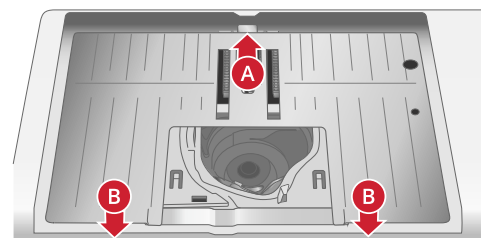

Troubleshooting

In this troubleshooting guide you will find solutions to the problems you may have with your machine. For further information please contact your local authorized HUSQVARNA® VIKING® retailer who will be happy to help you.

General Problems

Bobbin alarm does not work	Clean lint from bobbin area and use only the original HUSQVARNA® VIKING® bobbins designed especially for this model.
Thread cutter does not cut the thread	Remove needle plate and clean lint from bobbin area. Enable automatic thread cutter in the settings menu.
Fabric does not feed	Make sure the machine is not set for Free-Motion sewing. Make sure the feed teeth are raised.
Wrong stitch, irregular or narrow stitch	Deactivate twin needle or stitch width safety in the settings menu.
The needle breaks	Insert needle correctly as described, see Changing the Needle, page 32 . Use a needle suitable for selected fabric. See Selecting Correct Thread/Needle Combination, page 34 .
The machine will not sew	Check that all plugs are securely inserted into the machine and the wall socket.
Poor result	Use only accessories designed for your Topaz™ 55Q machine. Follow the on-screen recommendations.
The machine screen and/or function buttons do not respond to touch	The sockets and function buttons on the machine can be sensitive to static electricity. If the screen does not respond to touch, turn the machine OFF and then ON again. If the problem persists, contact your authorized HUSQVARNA® VIKING® retailer.
When sewing in heavy and/or dense fabrics the machine emits a distinct sound different from the sound normally generated when sewing.	The sound is not an indication of malfunction. The machine is equipped with a pulsating needle piercing feature that helps the needle to penetrate heavy and/or dense fabrics. The sound is caused when the presser foot and fabric lift with the needle. Increase the presser foot pressure to prevent the foot from lifting. If the sound does not seem to be related to the pulsating needle piercing feature, contact your authorized HUSQVARNA® VIKING® retailer for service.

The Automatic Needle Threader Does Not Work Properly

The needle eye is too small for the thread	Use a larger needle size or lighter weight thread. See Selecting Correct Thread/Needle Combination, page 34
Are you using a specialty thread such as an “invisible” or other stretchy thread, metallic or flat metallic thread or heavy weight thread?	Specialty threads may not be caught correctly by the hook on the automatic needle threader. If this happens, the needle will not be threaded. Try using the automatic needle threader again or thread the needle manually.
The needle is not threaded.	The needle threader is wrongly threaded. Re-thread and try again. If using thread that is too thick for the needle, the needle threader may not be able to pull the thread through the needle eye. Change to a lighter weight thread and retry.

The thread is tangled in the needle threader.	Remove the thread carefully so as not to damage the small hook that runs through the needle eye. Once the thread is removed, re-thread and try again.
The automatic needle threader does not return to its home position.	Contact your authorized HUSQVARNA® VIKING® retailer for service.

The Machine Skips Stitches

Did you insert the needle properly?	Insert needle correctly as described, see Changing the Needle, page 32 .
Did you insert a wrong needle?	Use needle system 130/705 H. Use a needle suitable for selected fabric and thread. See Selecting Correct Thread/Needle Combination, page 34 .
Is the needle bent or blunt?	Insert a new needle.
Did you thread the machine properly?	Remove the thread completely and rethread the machine, see Threading the Upper Thread, page 33 .
Is the correct presser foot used?	Attach correct presser foot.
Is the needle too small for the thread?	Change the needle.
Is the fabric moving up and down with the needle when Free-Motion sewing?	If using the Embroidery/Darning Foot R, decrease the pivot height in settings menu in small increments until the problem is solved.

Needle Thread Breaks

Did you insert the needle properly?	Insert needle correctly, see Changing the Needle, page 32 .
Did you insert a wrong needle?	Use needle system 130/705 H. Use a needle suitable for selected fabric and thread. See Selecting Correct Thread/Needle Combination, page 34 .
Is the needle bent or blunt?	Insert a new needle.
Did you thread the machine properly?	Remove the thread completely and rethread the machine, see Threading the Upper Thread, page 33 .
Does the thread slide down and get caught under the thread spool?	Use a thread net over the spool. See Threading Tips and Hints, page 36 .
Is the needle too small for the thread?	Change the needle to the proper size for the thread.
Are you using poor thread with slubs or thread which has become dry?	Change to a new high quality thread purchased from an authorized HUSQVARNA® VIKING® retailer.
If using a spool cap on top of the spool, is it too small so the thread snags at the top of the spool?	Attach a spool cap slightly larger than the actual thread spool.
Is the best spool pin position used?	Try a different spool pin position (vertical or horizontal).
Is the needle plate hole damaged?	Change the needle plate.
Is the thread tension too high for selected thread?	Lower the thread tension in small increments until problem is solved.

Bobbin Thread Breaks

Is the correct bobbin used?	Use only bobbins especially designed for the Topaz™ 55Q machine.
Did you insert the bobbin properly?	Check the bobbin thread.

Is the needle plate hole damaged?	Change the needle plate.
Is the bobbin area full of lint?	Clean lint from bobbin area and use only the original bobbins approved for this model.
Is the bobbin wound correctly?	Wind a new bobbin.

The Seam has Uneven Stitches

Is the thread tension correct?	Check needle thread tension. Remove the thread completely and rethread the machine, see Threading the Upper Thread, page 33 .
Is the thread you are using thick or slubbed?	Change the thread.
Is the bobbin thread evenly wound?	Check bobbin winding.
Is a correct needle used?	Insert a proper needle correctly as described, see Changing the Needle, page 32 . Use a needle suitable for selected fabric. See Selecting Correct Thread/Needle Combination, page 34 .

The Machine Does Not Feed or Feeds Irregularly

Did you thread the machine properly?	Remove the thread completely and rethread the machine, see Threading the Upper Thread, page 33 .
Has sewing lint collected between the feed teeth?	Remove the needle plate and clean the feed teeth with the brush.
Is the Free-Motion setting on?	Turn off Free-Motion setting in sewing mode.
Are the feed teeth lowered?	Make sure the feed teeth are raised.
Is the correct presser foot used?	Attach correct presser foot.

Troubleshooting Connectivity

The Machine Cannot Connect to a WiFi Network

The machine will not connect to a WiFi network	Make sure that WiFi is enabled on your machine. Touch the WiFi button on the top bar or go to WiFi settings. Make sure that the machine detects a signal from your WiFi network. If there is no signal, move the machine closer to the WiFi router. Make sure you have selected your WiFi network.
The machine has no Internet connection	Make sure that your WiFi router has access to the Internet.
The WiFi network is password protected	Make sure that you have selected your WiFi network and entered the correct password. If you do not know the password, contact the administrator of your network.

Service

Have your sewing machine serviced regularly by your local authorized retailer!

If you have followed this troubleshooting information and still have problems, contact your retailer. It may be helpful to bring the fabric, thread and stabilizer you are using with you. If you have a stitch out that shows the problem, please bring that as well. A sewing sample will often give better information than words and help your technician diagnose the problem.

Non-Original Parts and Accessories

The warranty does not cover any defect or damage caused by use of non-original accessories or parts.

Technical specification

Sewing Speed 1000 stitches/minute maximum	Rated Voltage 100–240V, 50–60Hz	Nominal Consumption <100W
Light LEDs	Foot Control Model: FR5	Safety Class II (Europe)
WiFi Module Frequency: 2.4 GHz 802.11 b/g/n Transmitting power: +17 dBm Receiver sensitivity: -97 dBm	Machine Dimensions Length: 535 mm Width: 251 mm Height: 310 mm	Net Weight Machine only: 10.3 kg
Non-Load Power Consumption 0.5 W		

The technical specifications and this user's guide can be changed without prior notice.

You have purchased a modern, updatable sewing and embroidery machine. As we regularly release firmware updates, it is possible that there may be some differences between the machine firmware and the firmware described in the user's guide. Consult your local authorized HUSQVARNA® VIKING® retailer, and be sure to visit our website at www.husqvarnaviking.com for the latest updates of the firmware and the user's guide.

We reserve the right to change the machine equipment and the assortment of accessories without prior notice, or make modifications to the performance or design. Such modifications, however, will always be to the benefit of the user and the product.

INTELLECTUAL PROPERTY

Patents protecting this product are listed on a label positioned underneath the Sewing Machine.

CREATIVATE, EXCLUSIVE SENSOR SYSTEM, JOYOS ADVISOR, VIKING, and KEEPING THE WORLD SEWING & Design are trademarks of Singer Sourcing Limited LLC or its Affiliates.

HUSQVARNA and the "crowned H-mark" are trademarks of Husqvarna AB. All trademarks are used under license.



Please note that on disposal, this product must be safely recycled in accordance with relevant National legislation relating to electrical/electronic products. Do not dispose of electrical appliances as unsorted municipal waste, use separate collection facilities. Contact your local government for information regarding the collection systems available. When replacing old appliances with new ones, the retailer may be legally obligated to take back your old appliance for disposal free of charge.

If electrical appliances are disposed of in landfills or dumps, hazardous substances can leak into the groundwater and get into the food chain, damaging your health and well-being.



FR

Cet appareil, ses accessoires et piles se recyclent

À DÉPOSER EN MAGASIN



OU

À DÉPOSER EN DÉCHÈTERIE



Points de collecte sur www.quefairedemesdechets.fr
Privilégiez la réparation ou le don de votre appareil !



FR



Importer to the UK:

VSM UK

Ravensbank House, Ravensbank Drive

North Moons Moat, Redditch. B98 9NA, United Kingdom

Manufacturer

VSM GROUP AB, **SVP Worldwide**

Soldatorpsgatan 3, SE-54474, Jonkoping, SWEDEN

