

# performance icon™

## User's Guide

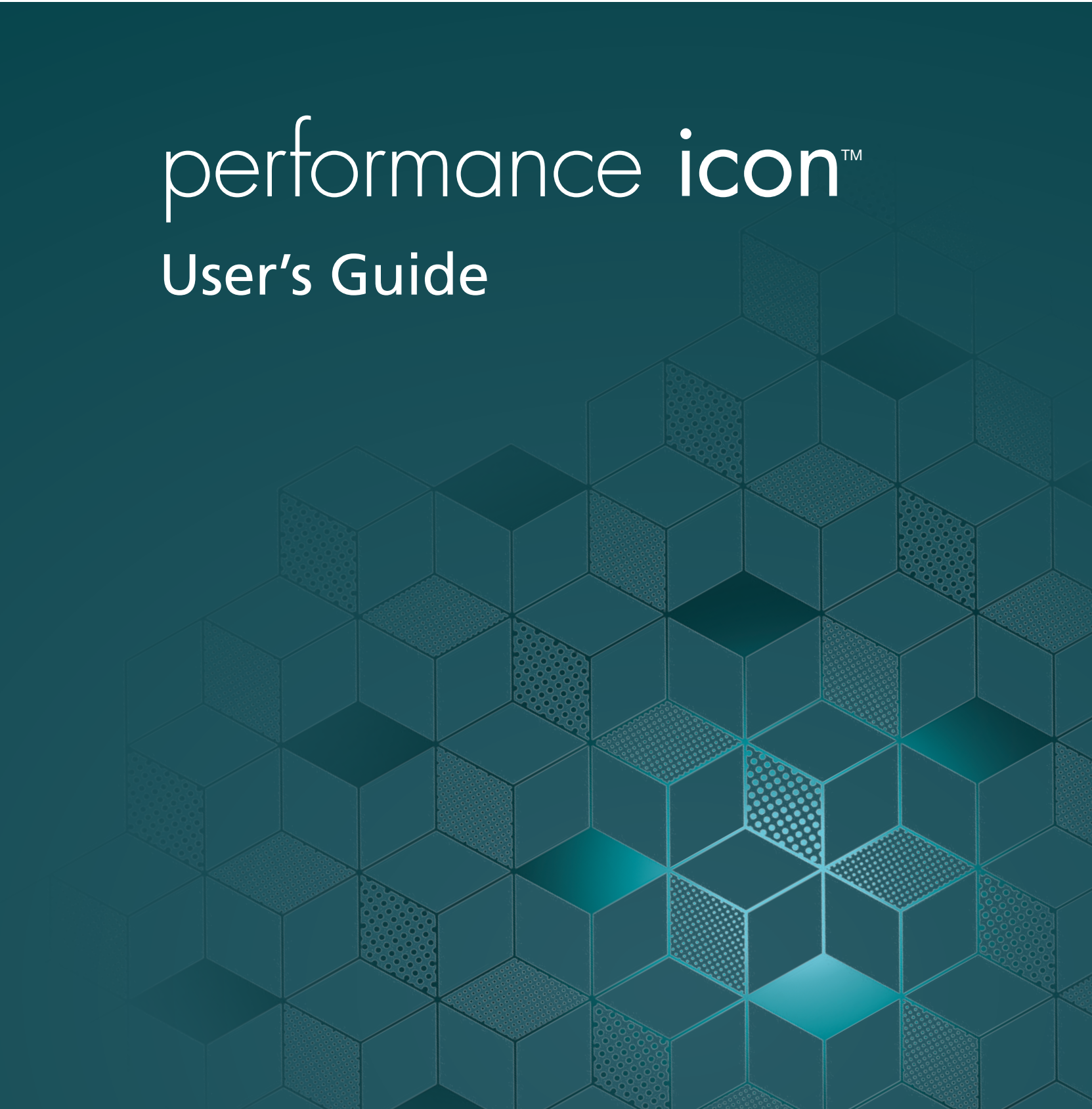

# TABLE OF CONTENTS

<b>1</b>	<b>Introduction</b> .....	<b>7</b>	Threading Tips and Hints .....	34	
	Machine Overview.....	7	Threading for Twin Needle .....	35	
	Front.....	7	Bobbin Winding.....	37	
	Needle Area.....	8	Winding Through the Needle.....	38	
	Right Side.....	8	Inserting the Bobbin.....	39	
	Rear.....	8	Changing the Bobbin Case.....	40	
	Top.....	9	IDT™ System (Integrated Dual Feed) .....	41	
	Accessory Tray.....	9	Engaging the IDT™ System.....	41	
	Storing a Needle Plate.....	10	Disengaging the IDT™ System .....	41	
	Function Buttons.....	11	Changing the Presser Foot.....	42	
	Presser Foot Up and Extra Lift.....	11	Remove Presser Foot.....	42	
	Presser Foot Down and Pivot .....	11	Attach Presser Foot.....	42	
	Automatic Needle Threader .....	11	Attaching the Sensormatic Buttonhole		
	Cut Function.....	12	Foot .....	42	
	Immediate Tie-Off .....	12	Changing to Straight Stitch Needle Plate .....	43	
	Stitch Re-Start.....	12	<b>3</b>	<b>The Multi-Touch Screen.....</b>	<b>44</b>
	Needle Stop Up/Down.....	12		Multi-Touch Screen.....	44
	Start/Stop.....	12		Gestures.....	44
	Reverse .....	12		Start Page .....	45
	Basic Gestures for the Multi-Touch			Start Sewing.....	45
	Screen .....	13		Load From <i>mySewnet</i> ™ .....	45
	Accessories.....	14		Open Help Center.....	45
	Included Accessories .....	14		mySewnet™ Blog.....	45
	Presser Feet .....	15		Main Functions .....	46
	Stitch Overview .....	17		Save.....	46
	Utility Stitches.....	17		Home .....	46
	Stitch Menu Overview .....	20		Mode Switch .....	46
	Alphabets .....	20		Common Functions.....	46
<b>2</b>	<b>Preparations</b> .....	<b>21</b>		OK.....	46
	Unpacking Machine.....	21		Cancel.....	46
	Connect the Power Cord and Foot			Touch & Hold .....	46
	Control .....	21		Settings with Toggle Function .....	47
	Pack Away After Sewing.....	22		Help Center.....	48
	USB Ports .....	22		User's Guide .....	48
	Using a USB device.....	22		Getting Started .....	48
	Getting Started with WiFi and			Techniques and Tutorials .....	48
	<i>mySewnet</i> ™ Cloud.....	23		Sewing Instructions .....	48
	LED Lights .....	23		Stabilizer Guide.....	48
	Free Arm .....	23		Settings.....	49
	Manual Thread Cutter .....	23		Sewing Settings .....	49
	Knee-Lift .....	24		Machine Settings .....	52
	Speed Control Lever .....	24		WiFi Settings.....	53
	Thread Sensor .....	24		<i>mySewnet</i> ™ Settings.....	53
	Telescopic Thread Guide .....	25		Machine Information .....	53
	Spool Pins.....	26		Smart Toolbox.....	54
	Spool Caps .....	26		Top Bar.....	54
	Threads .....	27		Help Center.....	54
	Needles .....	28		Quick Help .....	55
	Important Needle Information.....	28		Main Menu .....	55
	Changing the Needle .....	29		Information Area .....	55
	Threading.....	30		WiFi .....	56
	Threading the Upper Thread.....	30		<i>mySewnet</i> ™ .....	56
	Automatic Needle Threader .....	32		Recommendations .....	56
				Information.....	56

Active Features.....	57	Balance .....	80
Menu Panel .....	57	Sewing Programs .....	81
Options Selected From the Menu Panel .....	57	Tapering Stitches .....	81
Toolbar .....	58	Taper Satin Stitch Exercise.....	81
Customize Your Work Area .....	58	Stitch Repeat .....	82
Full Screen View .....	58	Patchwork Program.....	82
Base Bar .....	58	Single Stitch Program.....	82
		Combining Programs.....	82
4 WiFi & <i>mySewnet</i> <sup>™</sup> Services .....	59	Sewing Techniques .....	83
WiFi Introduction .....	59	Buttonholes .....	83
Getting Started With WiFi .....	59	Sew On a Button.....	84
Hidden Network .....	59	Four Direction Sewing .....	84
Firmware Update Using WiFi .....	59	Special Stitch Techniques.....	85
Firmware Update Using a USB Device.....	59	Ribbon Stitches.....	85
<i>mySewnet</i> <sup>™</sup> Services .....	60	Stacking Stitches.....	85
<i>mySewnet</i> <sup>™</sup> Account.....	60	Floating Stitches .....	86
<i>mySewnet</i> <sup>™</sup> Cloud .....	60	Radiant Stitches.....	87
Used Space in <i>mySewnet</i> <sup>™</sup> Cloud.....	61	Lace Edge Stitches .....	87
Installation of <i>mySewnet</i> <sup>™</sup> cloud Sync		Optional Feet Stitches .....	87
Tool for Computer.....	61	Pop-up Messages in Sewing .....	88
<i>mySewnet</i> <sup>™</sup> Portal.....	62		
Troubleshooting Connectivity .....	62	6 Sequence Creator .....	90
		Sequence Creator – Introduction .....	90
5 Sewing.....	64	Sequence Creator – Overview .....	91
Sewing Mode – Introduction .....	64	Getting Started with Sequence Creator .....	93
Sewing Mode – Overview .....	64	Load a Stitch .....	93
Getting Started with Sewing.....	67	Load a Font .....	93
Load a Stitch From the Menu Panel.....	67	Adjust text and stitches .....	94
Select a Stitch From the Selection Menu.....	68	Delete a Stitch or Letter .....	94
Load a Stitch from File Manager .....	68	Duplicate a Stitch or Letter .....	94
Sewing Recommendations.....	69	Replace a Stitch or Letter .....	94
Settings in Sewing Mode .....	70	Directional Stitches .....	95
<b>ActivStitch</b> <sup>™</sup> Technology .....	70	Sequence Commands.....	96
Automatic Presser Foot Lift.....	71	True Size.....	96
Automatic Thread Cutter .....	71	Saving a Sequence.....	97
Free-Motion Options.....	71	Sew Your Sequence.....	97
Stitch Limiting Options .....	72	Adjust the Entire Sequence.....	98
Needle Stop Position.....	73	Using Sequence Creator in Sewing Mode ....	98
Presser Foot Pressure .....	73	Pop-up Messages in Sequence Creator.....	99
Options for Feed Dogs .....	73		
Tie-Off Options .....	73	7 <b>Stitch Creator</b> <sup>™</sup> Feature .....	100
Stitch Edit.....	74	<b>Stitch Creator</b> <sup>™</sup> Feature – Introduction.....	100
Stitch Width .....	74	<b>Stitch Creator</b> <sup>™</sup> Feature – Overview .....	101
Stitch Positioning.....	74	Getting Started with <b>Stitch Creator</b> <sup>™</sup> .....	102
Stitch Length.....	74	Definition of a Stitch Point.....	102
Stitch Density .....	75	Select Stitches/Stitch Points.....	102
Mirroring .....	75	Preview .....	103
Buttonhole Slit Length .....	75	<b>Stitch Creator</b> <sup>™</sup> Edit Tools .....	103
Button Stitch Repetition .....	75	Zoom.....	103
<b>ActivStitch</b> <sup>™</sup> Technology .....	76	Move .....	103
Free-Motion Options.....	77	Add a Stitch or Stitch Point .....	104
Dynamic Spring Foot 6D Free-Motion.....	77	Duplicate Selected Stitch Point .....	104
Spring Foot Free-Motion .....	77	Triple Stitch.....	104
Sensormatic Free-Motion.....	78	Mirroring .....	104
Tie-Off Options .....	78	Delete Selected Stitch Point .....	104
Stitch Repeat .....	79	Edit a stitch made in <b>Stitch Creator</b> <sup>™</sup> .....	105
Save Stitch.....	80	Load and Sew a Stitch.....	105

Saving a Stitch.....	105
Using Created Stitches in Sequence Creator .....	105
Pop-up Messages in <b>Stitch Creator™</b> Feature .....	105
<b>8 Help Center .....</b>	<b>106</b>
Help Center - Introduction.....	106
Help Center - Overview .....	106
User's Guide .....	107
Getting Started .....	108
Techniques and Tutorials .....	109
Garment Techniques.....	109
Sewing Techniques .....	110
Quilting Techniques .....	110
Stabilizer Guide .....	110
Projects .....	111
Project Viewer.....	111
Video Player.....	112
<b>9 File Manager .....</b>	<b>113</b>
File Manager - Introduction.....	113
File Manager - Overview.....	114
File Formats.....	116
Browse File Manager .....	116
Open a File or Folder .....	116
Multi-Select .....	116
<i>mySewnet™</i> Cloud Folder .....	116
USB Device.....	116
List/Thumbnail View .....	117
Move up One Folder Level.....	117
Organize.....	117
Create New Folder.....	117
Rename a File or Folder .....	117
Move a File or Folder .....	117
Copy a File or Folder .....	118
Delete a File or Folder .....	118
Pop-up Messages in File Manager.....	118
<b>10 Maintenance .....</b>	<b>120</b>
Cleaning the Machine Exterior .....	120
Removing the Needle Plate and Cleaning the Bobbin Area .....	120
Cleaning Under the Bobbin Area .....	120
Replacing the Needle Plate.....	121
Troubleshooting.....	121
Service.....	124
Non-Original Parts and Accessories.....	124
Technical specification.....	124
<b>11 IMPORTANT .....</b>	<b>126</b>
IMPORTANT SAFETY INSTRUCTIONS.....	126
DANGER -TO REDUCE THE RISK OF ELECTRIC SHOCK:.....	126

WARNING -TO REDUCE THE RISK OF BURNS, FIRE, ELECTRIC SHOCK, OR INJURY TO PERSON: .....	126
SAVE THESE INSTRUCTIONS .....	126
SERVICING OF DOUBLE INSULATED PRODUCTS .....	127
Licenses.....	127

# 1 Introduction

## Machine Overview

### Front

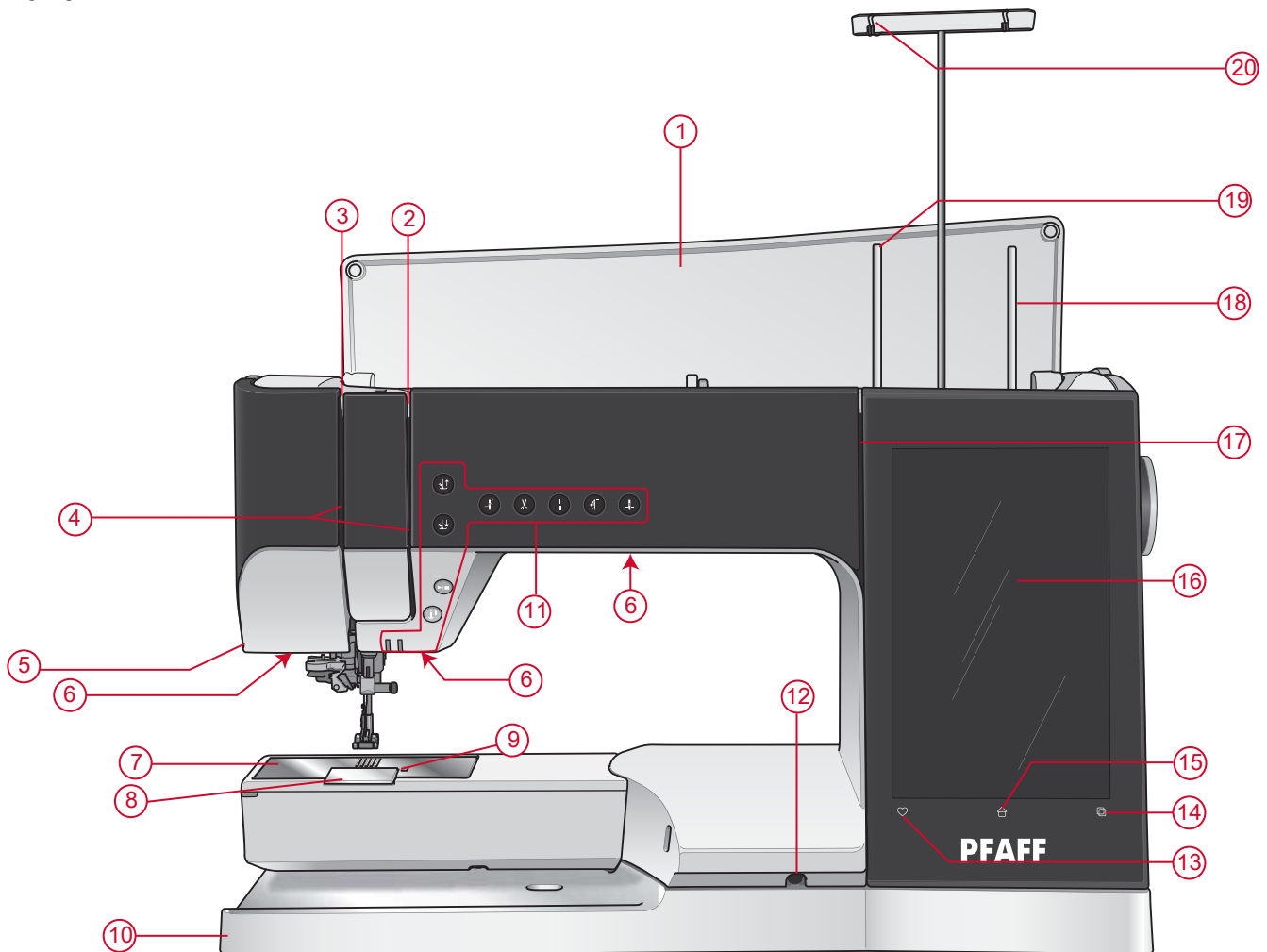

1. Lid
2. Thread tension discs
3. Thread take-up lever
4. Threading slot
5. Thread cutter
6. LED light
7. Needle plate
8. Bobbin cover
9. Bobbin cover release button
10. Base plate
11. Function buttons, see [Function Buttons](#), page 11 for detailed description
12. Knee lifter socket
13. Save
14. Mode switch
15. Home
16. Multi-touch screen
17. Bobbin winding thread slot
18. Auxiliary spool pin
19. Main spool pin
20. Telescopic thread guide

## Needle Area

1. Automatic needle threader, see [Using the Automatic Needle Threader, page 33](#)
2. Needle bar with needle clamp screw
3. Needle thread guide
4. Presser foot bar
5. IDT™
6. Presser foot ankle
7. Presser foot

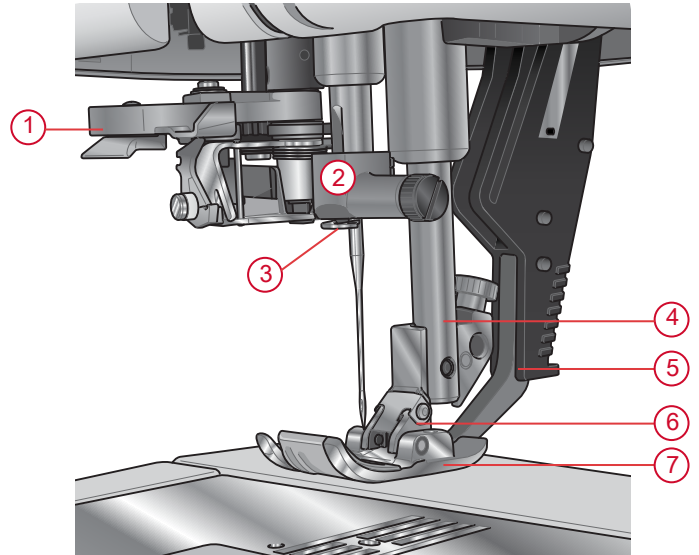

## Right Side

1. Handwheel
2. Speaker
3. Built-in USB ports
4. Speed control lever
5. ON/OFF switch, sockets for power cord and foot control. See [Connect the Power Cord and Foot Control, page 21.](#)

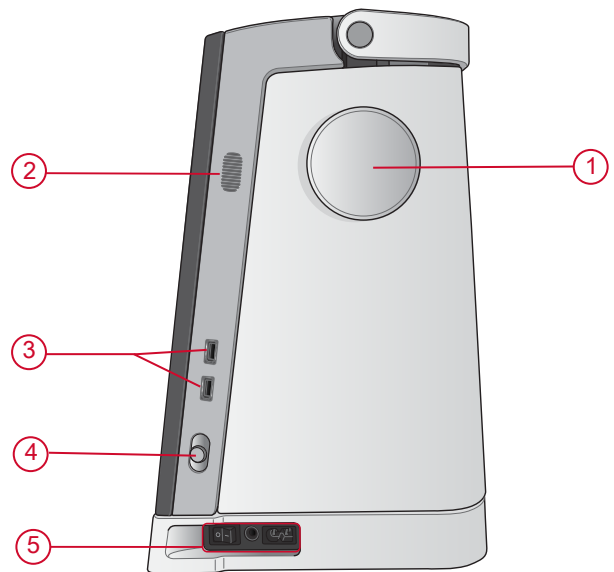

## Rear

1. Handle
2. Accessory socket
3. Free arm

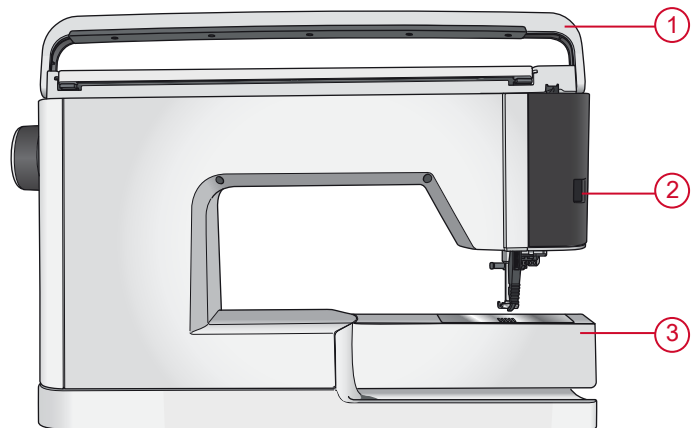

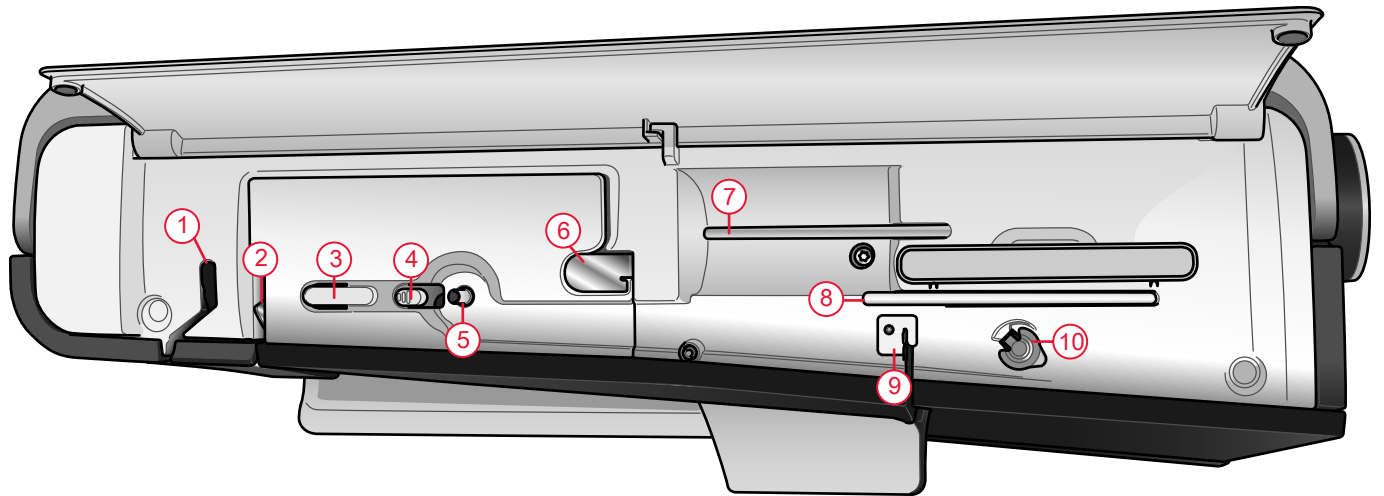

- |  |  |
|--|--|
| <ul style="list-style-type: none"> <li>1. Thread take-up lever</li> <li>2. Thread tension discs</li> <li>3. Thread cutter</li> <li>4. Bobbin winder lever</li> <li>5. Bobbin winder</li> </ul> | <ul style="list-style-type: none"> <li>6. Pre-tension thread guide</li> <li>7. Main spool pin</li> <li>8. Auxiliary spool pin</li> <li>9. Bobbin winding thread guide</li> <li>10. Thread tension disc for bobbin winding</li> </ul> |
|--|--|

*Note: The machine is delivered with two red safety catches; one attached to the presser foot bar and one in the accessory tray. These should all be removed before sewing.*

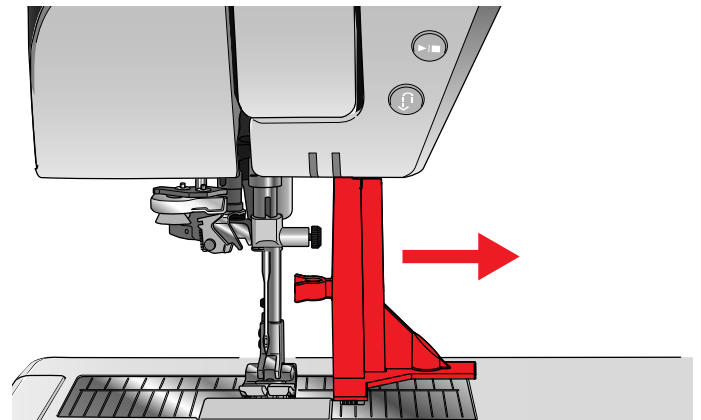

### Accessory Tray

The accessory tray features special compartments for presser feet and bobbins, plus space for needles and other accessories. Store the accessories in the tray so they are easily accessible.

- 1. Space for accessories
- 2. Space for needle plate
- 3. Spaces for presser feet
- 4. Spaces for bobbins
- 5. Space with hole for 5M Manual Buttonhole Foot
- 6. Safety catch (remove before sewing)

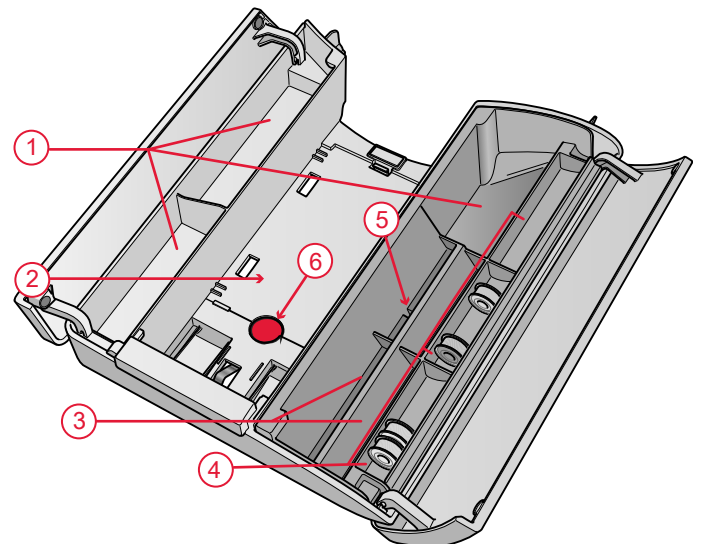

## Storing a Needle Plate

Store the needle plate not in use in the bottom of your accessory tray.

1. Insert the right side of the plate into spring on the right side (A), push it slightly. Lay it down (B) so that the needle plate snaps into place.
2. To remove the plate, place a finger into the hole by the left side of the plate, push it to the right and then lift the plate.

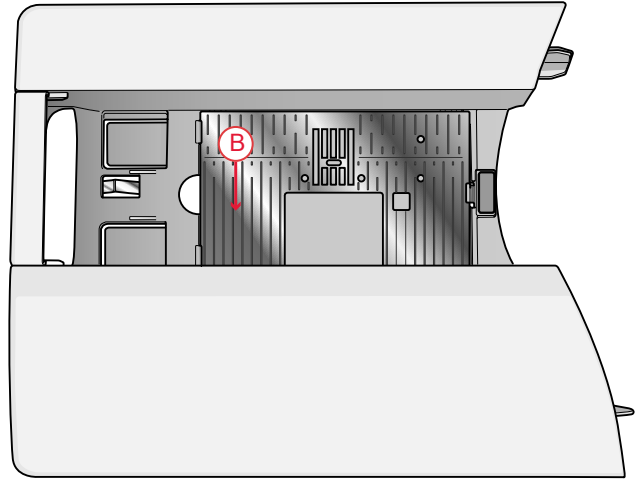
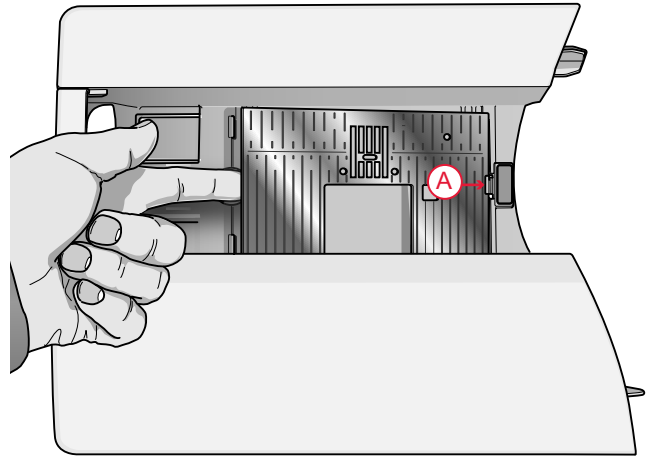

## Function Buttons

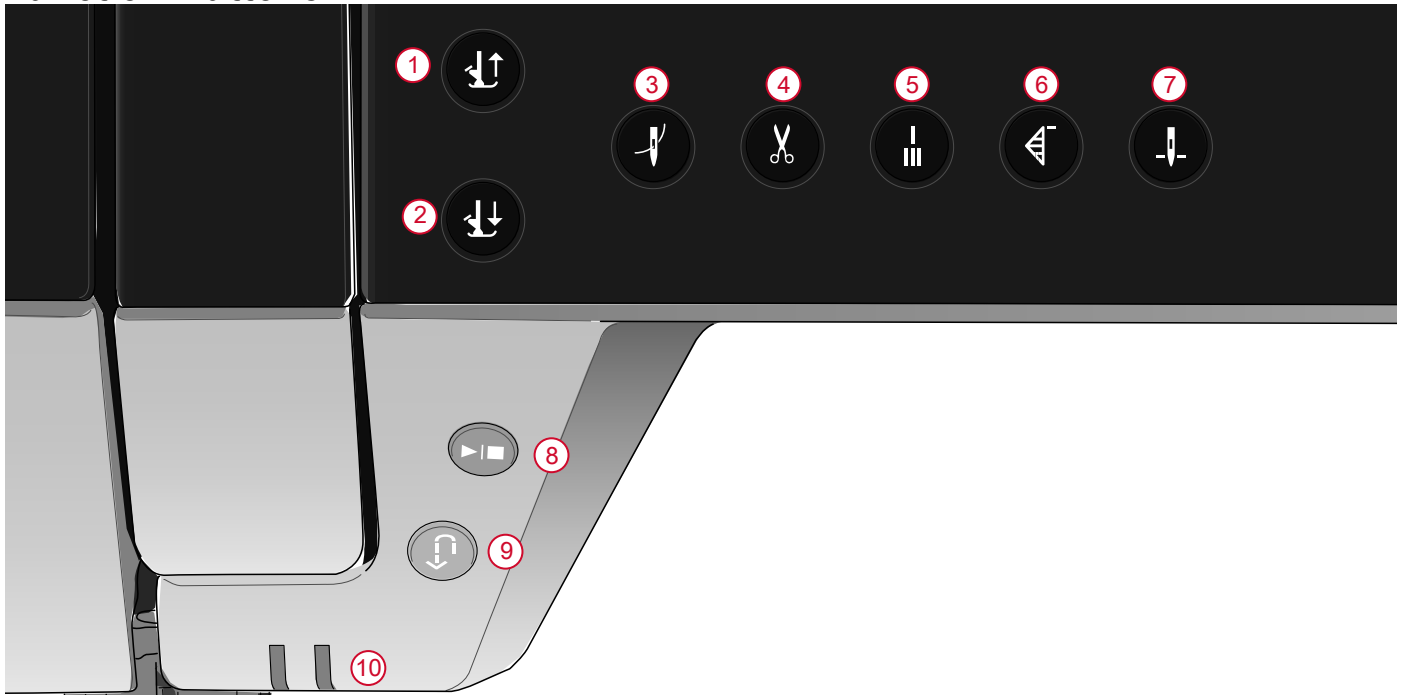

- |  |                               |                             |
|--|-------------------------------|-----------------------------|
| 1. <u>Presser foot up and extra lift</u> | 5. <u>Immediate tie-off</u>   | 9. <u>Reverse</u>           |
| 2. <u>Presser foot down and pivot</u>    | 6. <u>Stitch restart</u>      | 10. <u>Indication Light</u> |
| 3. <u>Automatic needle threader</u>      | 7. <u>Needle stop up/down</u> |                             |
| 4. <u>Cut function</u>                   | 8. <u>Start/stop</u>          |                             |

### Presser Foot Up and Extra Lift

Touch the presser foot up button once to raise the presser foot. Touch again and the presser foot will raise to extra lift position, and the feed teeth will be automatically lowered to make it easier to get heavy fabric under the presser foot.

### Presser Foot Down and Pivot

The presser foot is lowered automatically when you start sewing. To lower the presser foot before starting to sew, touch the presser foot down and pivot button. The presser foot will be completely lowered and the machine

firmly holds the fabric. Touch presser foot down again to go to pivot position.

### Automatic Needle Threader

See [Using the Automatic Needle Threader, page 33](#) to learn how to place the thread for automatic needle threading. When the thread is in place, touch this button to thread the needle automatically.



*To prevent damage to the automatic needle threader, needle, presser foot or other attached accessories, read the instructions carefully on how to use the automatic needle threader before using it.*

## Cut Function

Touch the cut function button and your machine cuts the upper and bobbin threads and raises the presser foot and needle.

To cut threads at the end of a stitch or stitch sequence, touch the cut function button while sewing. The indicator light will intensify, alerting you that a cut is requested. When the stitch or stitch sequence is completed, your machine cuts the upper and bobbin threads and raises the presser foot and needle.

*Note: If automatic presser foot lift has been deselected in temporary session settings the presser foot will not be raised when using the cut function.*



*Some optional accessories are attached in the two small circular holes in the needle plate just above the bobbin cover. Do not use the cut function when an accessory is attached in these holes as that may interfere with the automatic thread cutter located under the needle plate.*

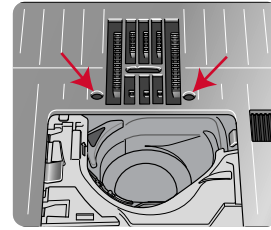

## Immediate Tie-Off

Press immediate tie-off while sewing and your machine sews a few tie-off stitches and stops automatically. By touching the tie-off button once more while the action indicator is lit, the function can be turned off.

## Stitch Re-Start

When you stop sewing in the middle of a stitch, touch stitch re-start to begin sewing at the beginning of the stitch. The stitch or stitch sequence will remember any special settings you made.

## Needle Stop Up/Down

Touch needle stop up/down to set the position of the needle when you stop sewing. The needle will move up or down when you touch the button. The indicator light intensifies when needle stop down is set.

*Tip: You can also tap the foot control to raise or lower the needle once you stop sewing. Tapping the foot control does not change the set stop position.*

## Start/Stop

Touch the start/stop button to start and stop the machine sewing without using the foot control. Touch start/stop to begin and touch again to stop.

## Reverse

When reverse is active, the reverse indicator intensifies. For permanent reverse, touch the reverse button once before starting to sew. The reverse indicator will intensify and the machine sews in reverse until you touch the button again to cancel. If you press the reverse button while sewing, the machine will sew in reverse for as long as you keep the button pressed.

Reverse is also used when sewing manual buttonholes, darning stitches and tapering stitches to step between the parts of the stitch.

# Basic Gestures for the Multi-Touch Screen

Easily navigate on the multi-touch screen with the gestures described below. For more detailed information, see [Multi-Touch Screen](#).

## Touch

Touch once on a button or setting on the screen to select.

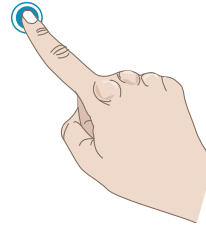

## Touch & Hold

Touch once without releasing for a few seconds to touch & hold. Used on some buttons and screen areas to access more options.

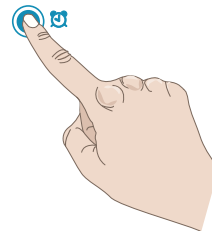

## Pinch/Stretch

Touch with two fingers at the same time and without releasing increase/reduce the distance between the fingers to stretch (zoom in) or pinch (zoom out).

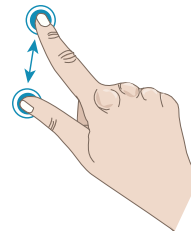

## Touch and Move

Touch once on e.g a window on your screen and, without releasing, move your finger to a different position on the screen.

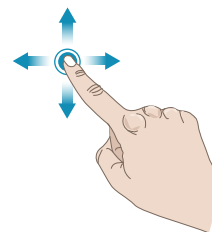

## Swipe

Touch, move and release your finger in a swift gesture to swipe. Left-right/right-left swipe is used to scroll between stitch menus. Top-bottom/bottom-top swipe is used to scroll within a stitch menu.

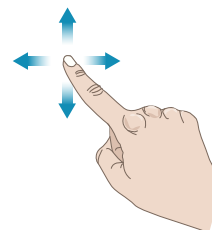

# Accessories

## Included Accessories

1. Thread net (4)
2. Screwdriver
3. Seam ripper
4. Brush
5. Bobbins (6)
6. Edge/Quilting guide (used attached to presser foot ankle)
7. Thread cone holder (2)
8. Spool cap, large (2)
9. Spool cap, medium (2)
10. Spool cap, small (2)
11. Large spool holder
12. Bobbin case for straight stitch left (black)
13. Knee lift
14. Straight Stitch Needle Plate
15. Multipurpose tool/Button reed

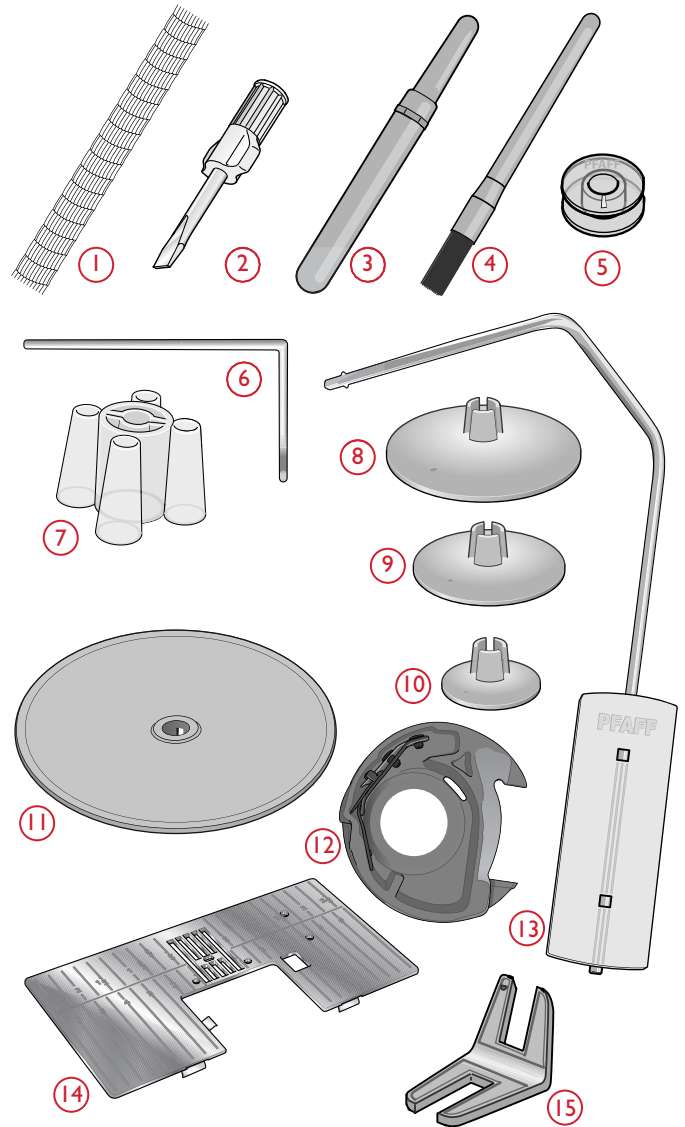

## Included Accessories Not in Picture

- Soft cover for machine
- Foot control
- Power cord
- Needles

# Presser Feet

Note: For the best sewing results, use only presser feet designed for and compatible with your performance icon™ machine.

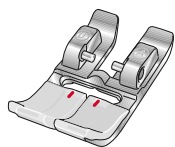

## OA - Standard Presser Foot for IDT™ System (attached on the machine upon delivery)

This foot is used mainly for straight stitching and zigzag stitching with a stitch length longer than 1.0 mm.

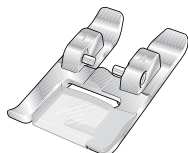

## 1A - Fancy Stitch Foot for IDT™ System

This foot is used for decorative stitches. The groove on the underside of the foot is designed to flow smoothly over the stitches.



## 2A - Fancy Stitch Foot

When sewing decorative stitches or short zigzag stitches and other utility stitches with less than 1.0mm stitch length, use this foot. The groove on the underside of the foot is designed to flow smoothly over the stitches.

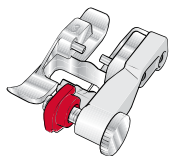

## 3 - Blindhem Foot for IDT™ System

This foot is used for blindhem stitches. The toe on the foot guides the fabric. The red guide on the foot is designed to ride along the fold of the hem edge.



## 4 - Zipper Foot for IDT™ System

This foot can be snapped on either the right or the left of the needle, making it easy to sew close to both sides of the zipper teeth. Move needle position to right or left to sew closer to zipper teeth.

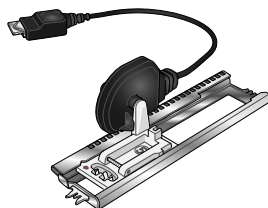

## 5A - Sensormatic Buttonhole Foot

When connected to the machine, the buttonhole is sewn in the length that has been entered into the machine.

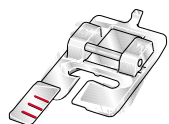

## 5M - Manual Buttonhole Foot

This foot is used for sewing manual buttonholes. Use the markings on the foot to position the garment edge. The finger on the back of the foot holds cording for corded buttonhole.



## 6A - Embroidery/Sensormatic Free Motion Foot

This foot is used for free motion sewing. This foot can also be used for darning.

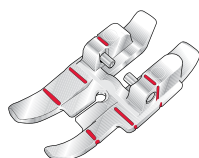

## 1/4" Quilting Foot for IDT™ System

This foot is perfect for piecing and patchwork, especially when used in conjunction with the straight stitch needle plate. The distance from the needle to the outer edge of the right toe is 1/4" (6mm). The distance from the needle to the inner edge of the right toe is 1/8" (3mm).

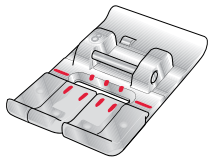

### 8 – Maxi Stitch Foot

This foot is used for side-motion stitches.

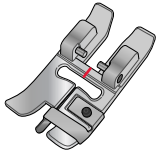









































### Bi Level Guide Foot for IDT™ System







The Bi Level Guide Foot is especially suitable for sewing the exclusive stitch techniques such as Edge stitches and floating stitches. The underside of the presser foot is designed to be higher on the right side, and has a guide in the center, allowing the presserfoot to glide along a folded edge.

# Stitch Overview

## Utility Stitches

Stitch	No	Name	Description
	1.1.1	Straight stitch	For seaming and topstitching.
	1.1.2	Stretch triple straight stitch	For reinforced seams and for top stitching.
	1.1.3	Stretch tricot stitch	For sewing seams on stretch fabrics.
	1.1.4	Basting stitch	For all types of sewing.
	1.1.5	Zigzag stitch	For reinforcing seams, clean finish and stretch sewing.
	1.1.6	Stretch triple zigzag stitch	Elastic stitch for decorative hems or topstitching.
	1.1.7	Three-step zigzag stitch	For stretch sewing, darning, patching, edge finishing and decorative sewing.
	1.1.8	Elastic stitch	For stretch sewing, darning, patching and lace insertion.
	1.1.9	Triple stretch stitch	For stretch sewing, darning, patching, edge finishing and decorative sewing.
	1.1.10	Z-zigzag stitch	For sewing appliqué.
	1.1.11	Honeycomb stitch	Decorative stitch for stretch fabrics and hems. Also used with elastic thread in the bobbin.
	1.1.12	Bridging stitch	Joining fabrics and quilt batting, decorative stitch for quilting, hemstitching.
	1.1.13	Foundation elastic stitch	Joining stitch for undergarments, terry cloth, leather, bulky fabrics where overlapping the seams.
	1.1.14	Crosshem stitch	Elastic decorative hem for stretch fabrics. Also suitable for joining fabrics and quilt batting.
	1.1.15	Blind hem stitch	For sewing blind hems on woven fabrics.
	1.1.16	Elastic blind hem stitch	For sewing blind hems on stretch fabrics.
	1.2.1	Closed overlock	For sewing seams and overcasting stretch fabrics in one step.
	1.2.2	Elastic overcast	For sewing seams and overcasting stretch fabrics in one step.
	1.2.3	Overlock	For sewing seams and overcasting stretch fabrics in one step.

Stitch	No	Name	Description
	1.2.4	Light knit fabric patching	For patching and sewing hems in stretch fabrics.
	1.2.5	Closed overlock	For patching, sewing hems, sewing seams and overcasting.
	1.2.6	Closed overlock for stretch	For patching, sewing hems, sewing seams and overcasting in stretch fabrics.
	1.2.7	Mock cover hem	Create the look of a serger cover hem for stretch fabrics.
	1.2.8	Mock cover hem	Create the look of a serger cover hem for stretch fabrics.
	1.2.9	Open overlock blind hem	Create decorative overlock blind hem for woven fabrics.
	1.2.10	Closed overlock blind hem	Create decorative overlock blind hem for stretch fabrics.
	1.3.1	Standard buttonhole	Basic buttonhole for blouses, shirts and jackets. Also for pillowcases.
	1.3.2	Rounded buttonhole with crosswise tack	Buttonhole for garments.
	1.3.3	Eyelet buttonhole with pointed tack	Tailors buttonhole or decorative buttonhole.
	1.3.4	Rounded buttonhole	Buttonhole for light garments or jackets.
	1.3.5	Stretch buttonhole	Buttonhole for stretch fabrics.
	1.3.6	Decorative eyelet buttonhole	Decorative buttonhole for jackets.
	1.3.7	Decorative eyelet buttonhole	Decorative buttonhole for jackets.
	1.3.8	Decorative eyelet buttonhole	Decorative heirloom buttonhole.
	1.3.9	Decorative round buttonhole	Decorative heirloom buttonhole.
	1.3.10	Button sewing	For sewing on buttons or tacking.
	1.3.11	Bound buttonhole	Foundation stitch for bound buttonhole.
	1.4.1	Eyelet	For belts, laces, heirloom sewing, etc.
	1.4.2	Decorative Eyelet	For belts, laces, heirloom sewing, etc.
	1.4.3	Decorative Eyelet	For belts, laces, heirloom sewing, etc.

Stitch	No	Name	Description
	1.4.4	Decorative Eyelet	For belts, laces, heirloom sewing, etc.
	1.4.5	Programmable darning stitch	To darn or mend small holes, begin stitching over hole, touch reverse for continuous darning and stop.
	1.4.6	Programmable reinforced darning stitch	Darn and mend work clothes, jeans, table cloths and linen towels. Stitch over hole, touch reverse for continuous darning and auto stop.
	1.4.7	Bartack	Reinforce pockets, shirt openings, belt loops as well as at lower end of a zipper.
	1.4.8	Denim bartack	Reinforce pockets, shirt openings, belt loops as well as at lower end of a zipper.
	1.4.9	Decorative bartack	Reinforce pockets, shirt openings, belt loops as well as at lower end of a zipper.
	1.4.10	Cross bartack	Reinforce pockets, shirt openings and belt loops.

## Stitch Menu Overview

There are several different stitch menus with stitches for all purposes. For detailed description of a stitch, use the quick help function, see [Quick Help](#).

Stitch Menu Name	Sub Menus
1 – Utility Stitches See also <a href="#">stitch table</a> for detailed descriptions.	<ol style="list-style-type: none"> <li>1. Essential stitches</li> <li>2. Overcast stitches</li> <li>3. Buttonholes</li> <li>4. Eyelets and darning stitches</li> </ol>
2 – Quilt Stitches	<ol style="list-style-type: none"> <li>1. Handlook quilt stitches</li> <li>2. Stippling stitches</li> <li>3. Crazy patch stitches</li> </ol>
3 – Needle Art Stitches	<ol style="list-style-type: none"> <li>1. Cross stitches</li> <li>2. Needlework stitches</li> <li>3. Antique hand embroidery stitches</li> </ol>
4 – Satin Stitches	<ol style="list-style-type: none"> <li>1. Scallop edges</li> <li>2. Satin elements</li> <li>3. Borders</li> </ol>
5 – Decorative Stitches	<ol style="list-style-type: none"> <li>1. Leaves and flowers</li> <li>2. Art stitches</li> <li>3. Ornamental stitches</li> <li>4. Maxi art stitches</li> </ol>
6 – Miscellaneous Stitches	<ol style="list-style-type: none"> <li>1. Bows and hearts</li> <li>2. Animals</li> <li>3. Fun stitches</li> </ol>
7 – Monogram Stitches	<ol style="list-style-type: none"> <li>1. Monogram 1</li> <li>2. Monogram 2</li> </ol>
8 – Stitch Techniques	<ol style="list-style-type: none"> <li>1. Single ribbon stitches</li> <li>2. Double ribbon stitches</li> <li>3. Triple ribbon stitches</li> <li>4. Stacking stitches</li> <li>5. Floating stitches</li> <li>6. Radiant stitches</li> <li>7. Lace edge stitches</li> </ol>
9 – Additional Stitches	<ol style="list-style-type: none"> <li>1. Optional feet stitches</li> <li>2. Four direction stitches</li> </ol>

## Alphabets

Stitch fonts are available in Block, Comic, Cyrillic, Grand, Outline and Script alphabets.

## 2 Preparations

### Unpacking Machine

After lifting the machine out of the box and removing all packing material and the plastic bag, wipe the machine, particularly around the needle and needle plate to remove any oil before sewing.

*Note: Your performance icon™ machine is adjusted to provide the best stitch result at normal room temperature. Extreme hot and cold temperatures can affect the sewn results.*

### Connect the Power Cord and Foot Control

Among the accessories you will find the power cord and the foot control.

*Note: Before plugging in the foot control, check to ensure that it is type "FR5" (see underside of foot control).*

1. Pull out the cord from the foot control. Connect the foot control cord to the front socket on the bottom right side of the machine.
2. Connect the power cord to the rear socket on the bottom right side of the machine. Plug the cord into the wall socket.
3. Press the ON/OFF switch to "I" to turn on power and light.

#### For the USA and Canada

This sewing machine has a polarized plug (one blade wider than the other). To reduce the risk of electric shock, this plug is intended to fit in a polarized outlet only one way. If the plug does not fit fully in the outlet, reverse the plug. If it still does not fit, contact a qualified electrician to install the proper outlet. Do not modify the plug in any way.

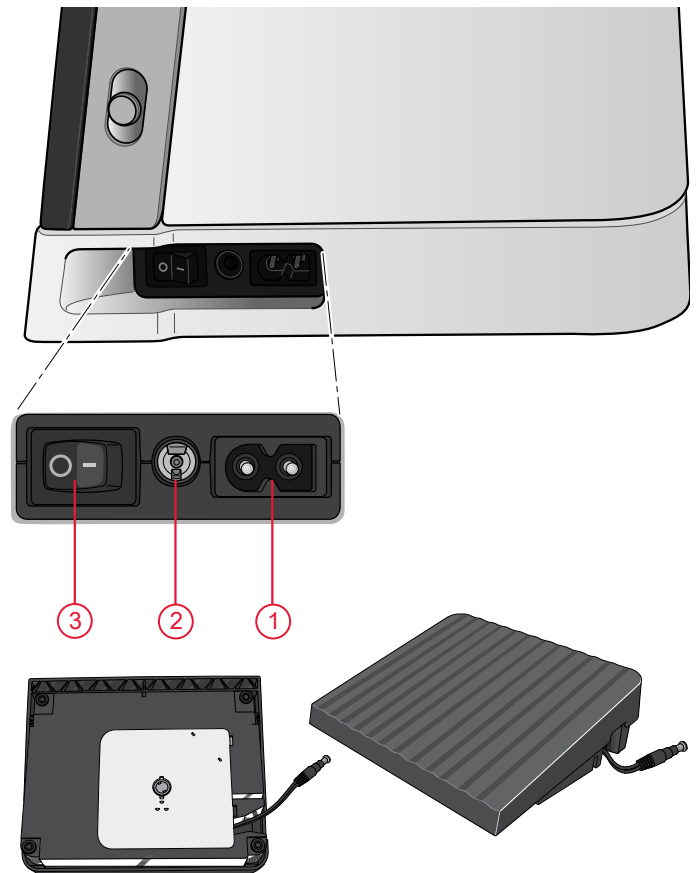

## Pack Away After Sewing

1. Press the ON/OFF switch to "O".
2. Unplug the cord from the wall socket and then from the machine.
3. Unplug the foot control cord from the machine. Pull the cord gently and release. The cord will retract into the foot control.
4. Place all accessories in the accessory tray. Slide the tray on to the machine around the free arm.
5. Place the foot control in the space above the free arm.
6. Put on the soft cover.

*Tip: The user's guide and power cord can be stored in the back pocket of the soft cover.*

## USB Ports

Your machine has two USB ports for connecting USB devices such as a memory stick. USB plugs can only be inserted one way – do not force them into the ports! To remove, carefully pull the USB device out straight.

*Note: Make sure that the USB stick you use has the format FAT32.*

## Using a USB device

The external device button in file manager is only active when a device is connected to a machine USB port.

*Note: Do not remove the USB device if a loading spinner is shown on the screen or while the file manager is shown. Removing the device at that time can damage the files on your USB device.*

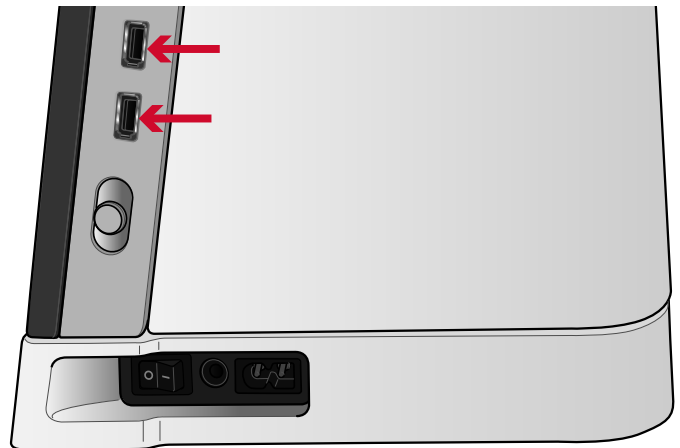

# Getting Started with WiFi and mySewnet™ Cloud

Follow the steps below to connect your machine.

## Connect to a Network with WiFi

Touch the WiFi button in the top left corner of the screen. Select from the list of available networks. If your network is password protected, you will be prompted to enter the password to connect.

For more information, see [WiFi Introduction](#).



WiFi icon

## Connect to mySewnet™ Cloud

When you have established a WiFi connection, touch the **mySewnet™** tab and touch the Sign in button. A web view opens where you can log in. If you do not have a user name and password, select Register to create an account.

For more information, see [mySewnet™ Cloud](#).

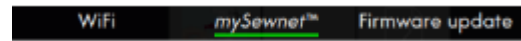

mySewnet™ cloud icon

## LED Lights

Your machine has LED lights which distribute the light evenly over the sewing area and eliminate shadows. You can adjust the brightness of the light in the settings menu, see [Machine Settings](#).

## Free Arm

To use the free arm, slide off the accessory tray. When attached, a hook keeps the accessory tray locked to the machine. Remove the tray by sliding it to the left.

## Manual Thread Cutter

There are three manual thread cutters on your machine. The first one is close to the bobbin winder spindle for cutting the thread after winding. The thread can be cut from sides.

The second one is next to the bobbin area for cutting the bobbin thread after placing the bobbin in the machine.

The third one is on the left side of the machine for manually cutting top and bobbin threads. Pull both threads into the cutter from the back to the front and pull down quickly.

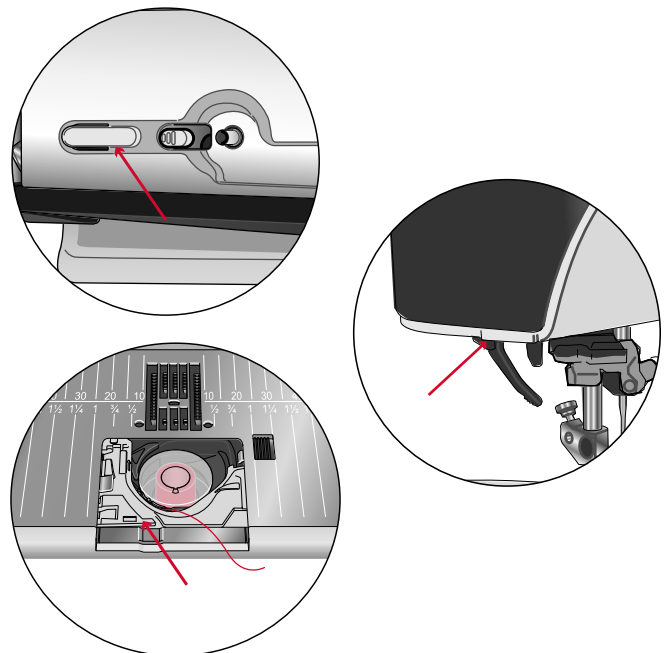

## Knee-Lift

Your machine comes with an electronic knee-lifter that allows you to lift the presserfoot with your knee. The knee-lifter is very helpful when sewing, since it allows you to handle the fabric with your hands while your knee lifts the presser foot to the desired height.

Match the ribs on your knee-lifter with the notches in the knee-lifter socket. Adjust the rectangular bar on the knee-lift until it is positioned at a comfortable height for you (A).

Move your knee lifter with your knee, and the presser foot will raise. You can raise the presser foot to three positions with your knee-lifter; pivot height, up, and extra lift position. When moving the presser foot to the extra lift position, the machine drops the feed teeth, allowing you to easily place thick fabrics underneath the presserfoot. The feed teeth will raise automatically when you start to sew.

To remove the knee-lift, just pull it straight out of the hole.

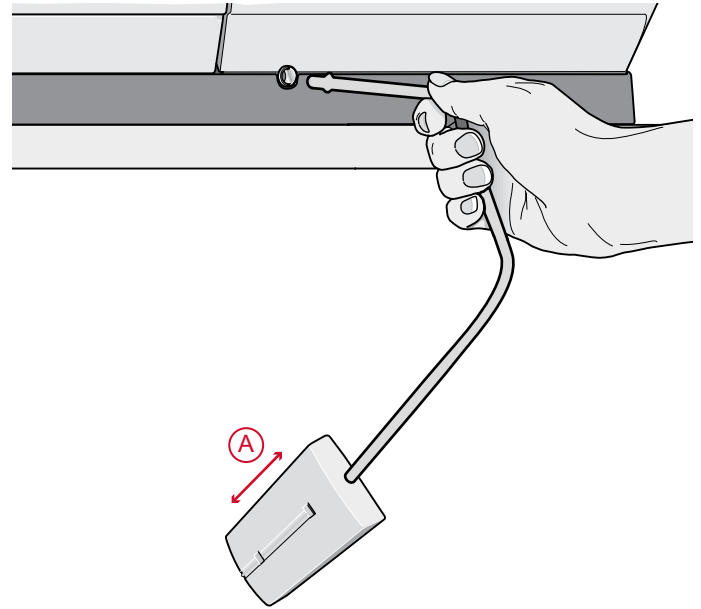

## Speed Control Lever

The speed control lever sets the maximum sewing speed. To increase sewing speed, slide the lever up, to decrease sewing speed, slide the lever down.

A pop-up appears on screen when adjusting the slider, indicating which speed level is set. The speed setting is also shown in the information area.

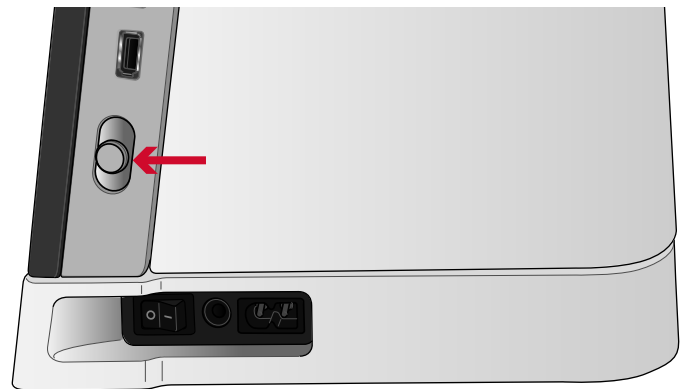

## Thread Sensor

If the needle thread breaks or bobbin thread is running low, the machine stops and a pop-up appears on the screen.

If needle thread breaks: Remove the thread completely, re-thread the machine and touch OK in the pop-up.

If bobbin thread is running low: You can continue sewing without closing the pop-up before the bobbin thread runs out completely. This gives you an opportunity to plan where to stop and change the bobbin. When the bobbin is replaced with a full one, touch OK in the pop-up.

## Telescopic Thread Guide

The telescopic thread guide is always used when threading your machine for sewing and bobbin winding. The telescopic thread guide helps straighten the thread, preventing it from tangling or breaking. The thread guide together with the vertical spool pins make it possible to successfully use very large thread cones.

### **Extending and Retracting the Telescopic Thread Guide**

Hold the telescopic thread guide as illustrated and pull it straight up, turn it until it clicks into place.

To retract, hold the thread guide and push it straight down.

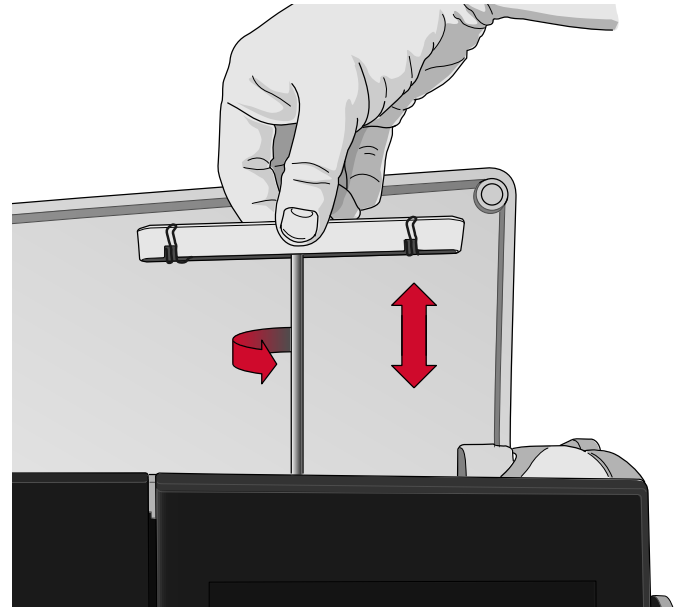

## Spool Pins

Your machine has two spool pins; a main spool pin and an auxiliary spool pin. The spool pins are designed for all types of thread.

Use the main spool pin (A) when threading the upper thread and for bobbin winding through the needle. For regular sewing and embroidery thread, use the main spool pin in vertical position. Place the spool pin in the horizontal position if you want to keep the machine threaded and close the lid when you have finished sewing. Remember to place the spool pin back in the vertical position when you start to sew again.

*Note: Tilting the spool pins is not possible with large thread spools or cones.*

You may get better results if you tilt the spool pin to the horizontal position when using small spools of specialty thread. See [Threading Tips and Hints, page 34](#).

Use the auxiliary spool pin (B) when winding a bobbin from a second spool of thread or for a second spool when sewing with a twin needle.

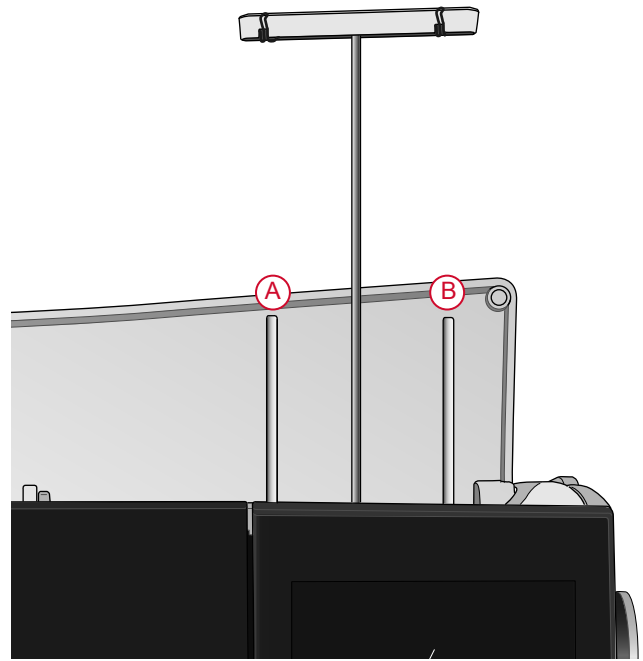

Main spool pin (A) and auxiliary spool pin (B)

## Spool Caps

Spool caps in three sizes are included with your machine. For most types of thread spools, no spool cap is needed except when the thread on the spool is running low. If the thread is snagging on the top of the thread spool, place a spool cap on top. Always use a spool cap slightly larger than the thread spool to prevent the thread from snagging. The flat side of the spool cap should be pressed firmly against the spool. There should be no space between the spool cap and the thread spool.

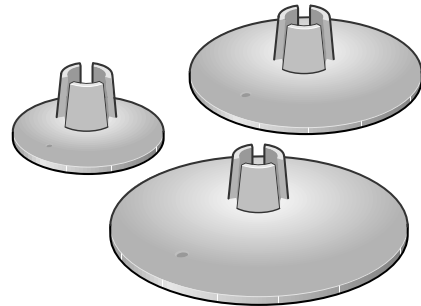

# Threads

There are many threads on the market today developed for different purposes.

Your performance icon™ machine is designed for all types of threads and spool sizes. See [Threading Tips and Hints, page 34](#) for information on achieving optimal results with different types of thread and different sizes/styles of thread spools.

## All Purpose Sewing Thread

All purpose sewing thread is made of synthetic, cotton or cotton covered polyester. This type of thread is used for most sewing projects, including garments, home decor, and quilting.

## Decorative Thread

Decorative thread is made from a variety of fibers: rayon, polyester, acrylic or metallic. These threads create a smooth glossy appearance for decorative stitching.

Decorative thread is not typically used in the bobbin unless both sides of the project will be seen. A light weight, bobbin thread is often used in the bobbin instead. The lighter weight thread does not build up under the stitches.

*Note: When using a metallic or a flat film thread, you may need to use a needle with a larger eye and lower the speed.*

## Transparent Thread

Transparent thread, also called monofilament thread, is a single clear synthetic thread. It is used for quilting and other sewing techniques. When winding a bobbin, wind at half speed and fill the bobbin half full.

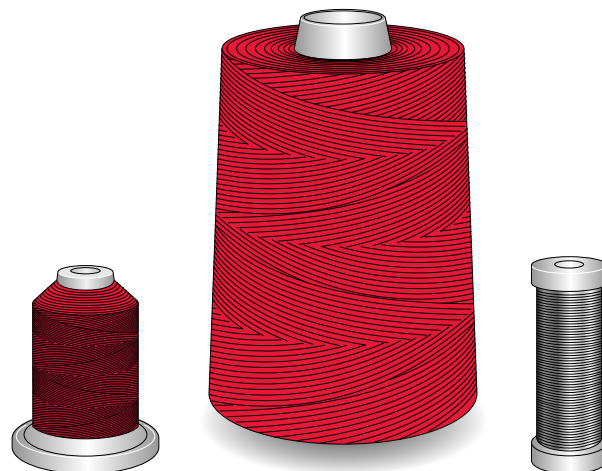

## Needles

The sewing machine needle plays an important role in successful sewing. Use only quality needles. We recommend needles of system 130/705H. The needle package included with your machine contains needles of the most frequently used sizes.



*Be sure to match the needle to the thread you are using. Heavier threads require a needle with a larger needle eye. If the needle eye is too small for the thread the automatic needle threader may not work properly.*

### Universal Needle

Universal needles have a slightly rounded point and come in a variety of sizes. For general sewing in a variety of fabric types and weights.

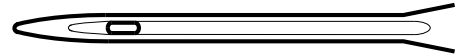

### Stretch Needle

Stretch needles have a special scarf to eliminate skipped stitches when there is a flex in the fabric. For knits, swimwear, fleece, synthetic suedes and leathers.

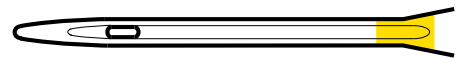

### Embroidery Needle

Embroidery needles have a special scarf, a slightly rounded point and a slightly larger eye to avoid damage to thread and materials. Use with metallic and other specialty threads for decorative sewing.

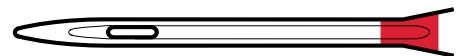

### Denim Needle

Denim needles have a sharp point to penetrate tightly woven fabrics without deflecting the needle. For canvas, denim, microfibers.

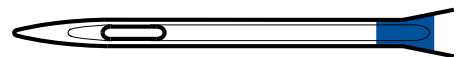

### Wing Needle

Wing needles have wide wings on the side of the needle to poke holes in the fabric when sewing entredeux and other hemstitches on natural fiber fabrics.

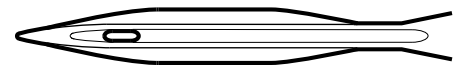

## Important Needle Information

Change the needle often. Always use a straight needle with a sharp point (A).

A damaged needle (B) can cause skipped stitches, breakage or snapping of the thread. It can also damage the needle plate.

Do not use asymmetrical twin needles (C), they can damage your sewing machine.

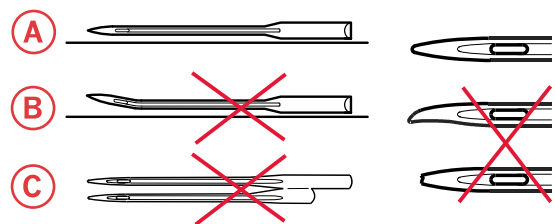

## Changing the Needle

1. Use the hole in the multipurpose tool to hold the needle.
2. Loosen the needle screw.
3. Remove the needle.
4. Insert the new needle using the multipurpose tool. Push the new needle upwards with the flat side away from you until it will go no further.



*It is very important that the needle is inserted all the way in order for the automatic needle threader to work properly.*

5. Tighten the needle screw carefully.

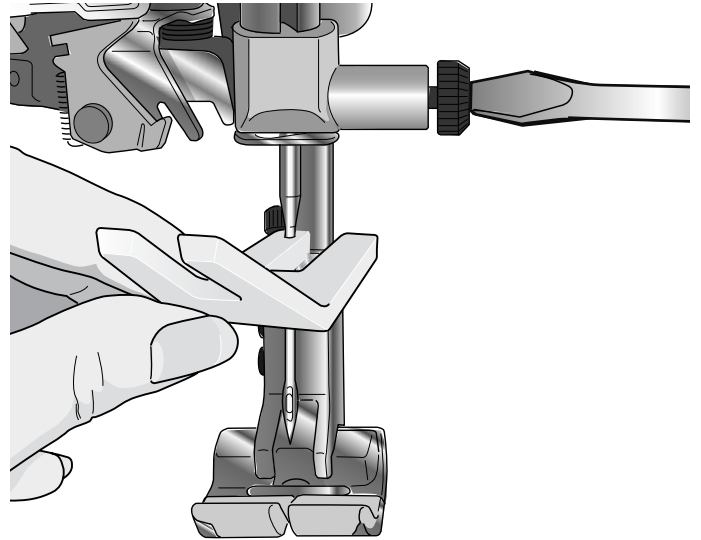

# Threading

Make sure that the presser foot and needle are in the up position.

## Threading the Upper Thread

For most regular thread qualities and spool sizes, threading the upper thread from the main (left) spool pin in the vertical position is recommended for optimal sewing results.

If you experience problems with the thread or sewing result, there are alternative ways to position the thread spool. See [Threading Tips and Hints, page 34](#).

1. Hold the telescopic thread guide and pull it straight up until it clicks into place.
2. Raise both spool pins to vertical position. Place the thread spool on the main spool pin (left). Using both hands, place the thread behind the left clip on the telescopic thread guide (A). The thread should run from right to left.

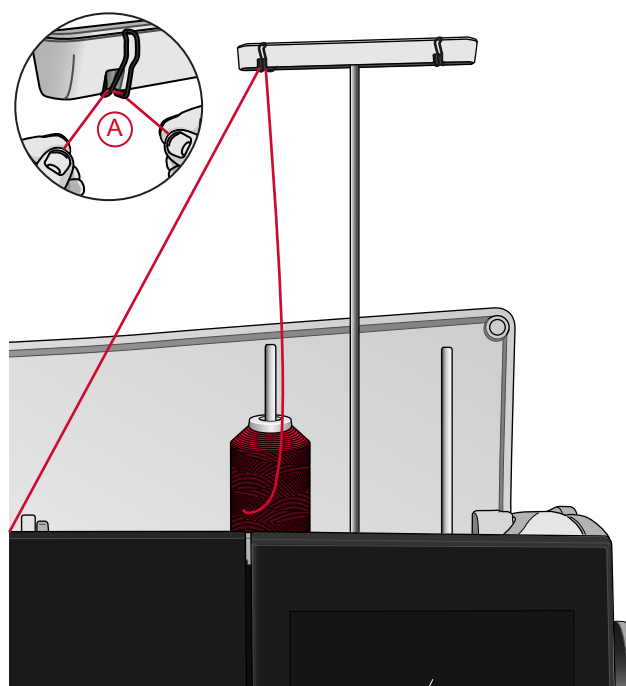
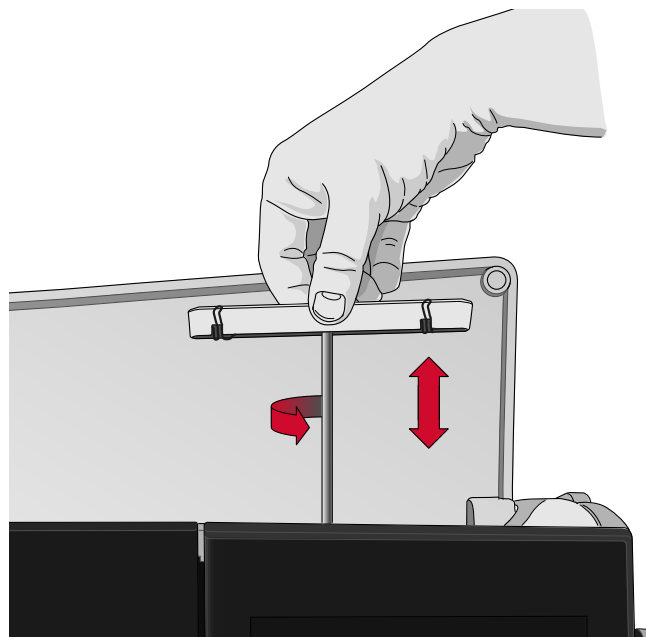

*Note: When using thread cones, place a cone holder on the spool pin before placing the thread cone. This prevents the thread cone from wobbling.*

*Tip: When removing the thread cone from the spool pin, the cone holder might become stuck inside the thread cone. Push it out gently from the top.*

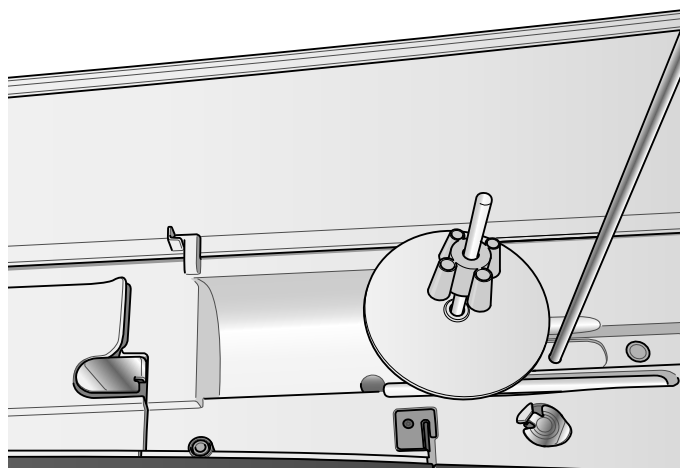

3. Hold the thread with two hands as illustrated. Floss the thread under the thread guide (A) from front to back. Pull thread back into and through threading slot (B).

*Note: Continue to hold the thread lightly next to the thread guide (A) throughout the threading process. This will create a bit of tension on the thread and ensure that the thread is properly seated in the threading path.*

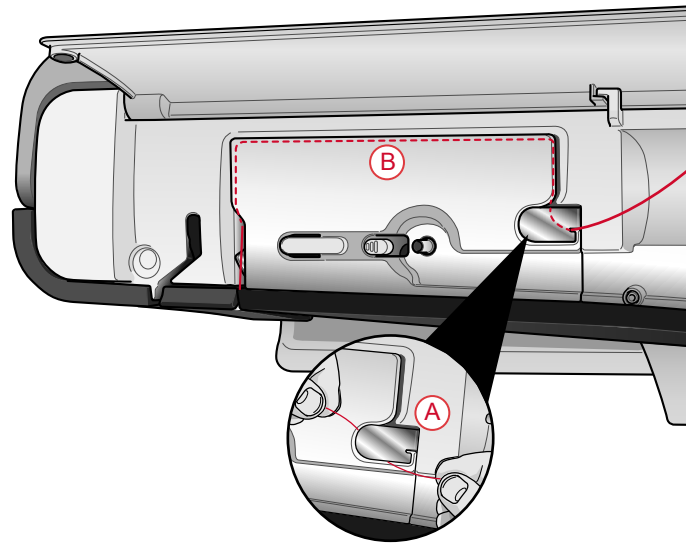

4. Pull the thread between the thread tension discs (C). Thread down through the right threading slot and then upwards through the left threading slot. Bring the thread from the right into the take-up lever (D) until it clicks into place (E), and down in the left threading slot to the last thread guide (F) just above the needle.
5. Thread the needle using the automatic needle threader or manually.



*Before using the automatic needle threader, carefully read the instructions and recommendations, see [Using the Automatic Needle Threader](#), page 33.*

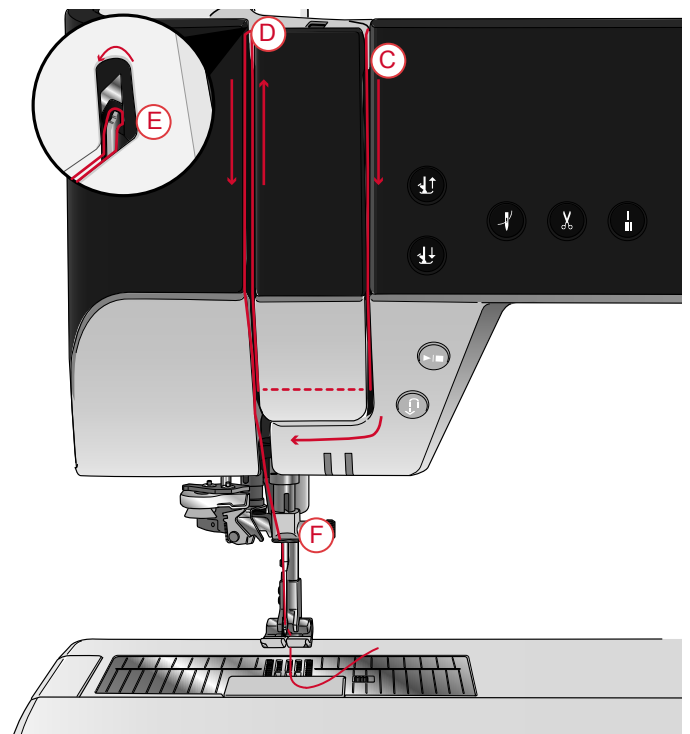

# Automatic Needle Threader

## Selecting Correct Thread/Needle Combination



The combination of the thread weight and the needle size is extremely important when using the automatic needle threader. Unsuitable combinations, such as using a heavy weight thread for a fine needle, may cause damage to the needle threader.

Avoid using fine needles with heavy fabrics to reduce the risk of bending the needle. Using the automatic needle threader with a bent needle may cause damage to the needle threader.

Fabric		Thread	Needle
Woven light	Chiffon, organza, batiste, challis, crepe de chine, etc.	Light weight threads: <ul style="list-style-type: none"> <li>• fine cotton, polyester or silk sewing thread</li> <li>• rayon embroidery thread</li> </ul>	Universal 130/705H 70/10-80/12
Woven medium	Calico, quilting fabrics, crepe, broadcloth, velvet, etc.	Medium weight threads: <ul style="list-style-type: none"> <li>• fine/normal cotton or polyester sewing thread</li> <li>• rayon embroidery thread</li> </ul>	Universal 130/705H 80/12-90/14
Woven heavy	Denim, tweed, canvas, terrycloth, etc.	Medium/heavy weight threads: <ul style="list-style-type: none"> <li>• normal cotton or polyester sewing thread</li> <li>• top stitching thread</li> <li>• rayon embroidery thread</li> </ul>	Universal 130/705H 90/14-110/18
Stretch light	Tricot, single knit jerseys, etc.	Light weight threads: <ul style="list-style-type: none"> <li>• fine cotton or polyester sewing thread</li> <li>• rayon embroidery thread</li> </ul>	Stretch 130/705H-S 75/11
Stretch medium	Sweater knits, double knit, velour, swimwear, etc.	Medium weight threads: <ul style="list-style-type: none"> <li>• normal cotton or polyester sewing thread</li> <li>• rayon embroidery thread</li> </ul>	Stretch 130/705H-S 90/14
Stretch heavy	Sweater knits, fleece, etc.	Medium weight threads: <ul style="list-style-type: none"> <li>• normal cotton or polyester sewing thread</li> <li>• rayon embroidery thread</li> </ul>	Stretch 130/705H-S 90/14
Leather	Suede and leather	Medium weight threads: <ul style="list-style-type: none"> <li>• normal cotton or polyester sewing thread</li> <li>• rayon embroidery thread</li> </ul>	Stretch 130/705H-S 90/14
Vinyl	Vinyl, faux leather and suede	Medium weight threads: <ul style="list-style-type: none"> <li>• normal cotton or polyester sewing thread</li> <li>• rayon embroidery thread</li> </ul>	Universal 130/705H 80/12

Note: Specialty fabrics and threads may require a special needle for best stitch results. Refer to your PFAFF® retailer for more information on needle types and sizes for your sewing needs.

## Using the Automatic Needle Threader

The needle threader allows you to thread the needle automatically by simply touching a button.

 *Make sure that the needle is inserted correctly and pushed up all the way into the needle clamp before using the automatic needle threader. Check that the needle is not damaged or bent, and make sure to match the thread weight and needle size according to our recommendations in Selecting Correct Thread/Needle Combination, page 32.*

1. Place the thread under the hook (A) and pull it between the discs (B) until it “clicks” into place.
2. Pull the thread up to the sewing head thread cutter and cut excess thread by pulling the thread from back to front in the thread cutter (C).

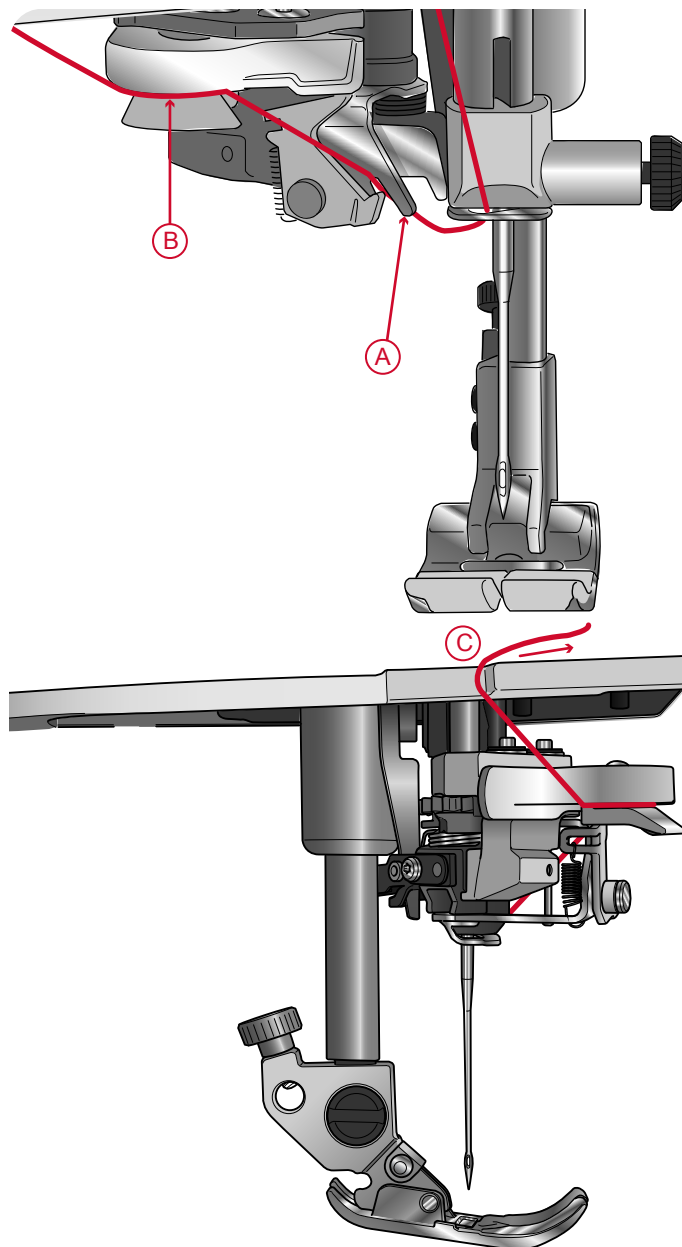

3. Touch the automatic needle threader button. The presser foot is automatically lowered during the threading sequence, and will rise again when threading is finished.

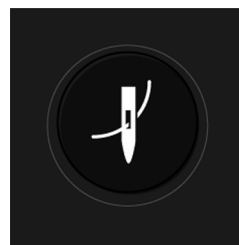

*The needle threader is designed to be used with needles size 70-120. You cannot use the needle threader with needles size 65 or smaller, wing needles, twin needles or triple needles.*

*Specialty threads such as invisible and other stretchy threads, metallic or flat metallic threads, and some heavy weight threads may not be caught correctly by the hook on the automatic needle threader. If this happens, the needle will not be threaded. Try using the automatic needle threader again or thread the needle manually.*

*When threading the needle manually, make sure that the needle is threaded from front to back.*

*The automatic needle threader cannot be used with all optional accessories available for your performance icon™ machine. To avoid damage to the needle threader and/or optional accessory we recommend using the automatic needle threader before attaching the accessory or thread the needle manually.*

## Threading Tips and Hints

There are many threads on the market today developed for different purposes. The quality and structure of the thread as well as the shape and size of the thread spool can affect the behavior of the thread. Threads can also behave differently if the spool is full or nearly empty.

If experiencing problems, try the tips and hints below.

*Note: Always test sew on a scrap piece of fabric to check the sewing result.*

### If the thread spool is pulled up on the spool pin

When the thread on the spool is running low, the thread can snag on the edge of the spool and pull the spool up on the spool pin. Place a spool cap on top of the thread spool to keep it in place. Always use a spool cap slightly larger than the thread spool to prevent the thread from snagging. The flat side of the spool cap should be pressed firmly against the spool. There should be no space between the spool cap and the thread spool.

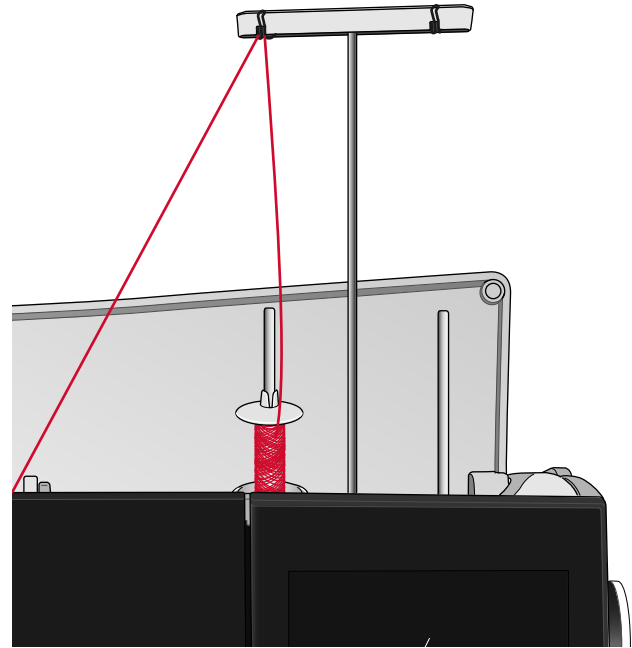

### If the thread slides down on the standing thread spool

If the thread is of a quality that unwinds easily and slides down on the standing thread spool it can get caught under the thread spool around the spool pin and break. Place the large spool holder on the spool pin with the flat side up before placing the thread spool.

If the thread spool has the same diameter as the large spool holder, place a thread net as illustrated from below over the spool before placing it on the spool pin.

*Note: To prevent snagging or increased thread tension on the thread, the thread net should cover the lower part of the thread spool only, not the top where the thread spool narrows.*

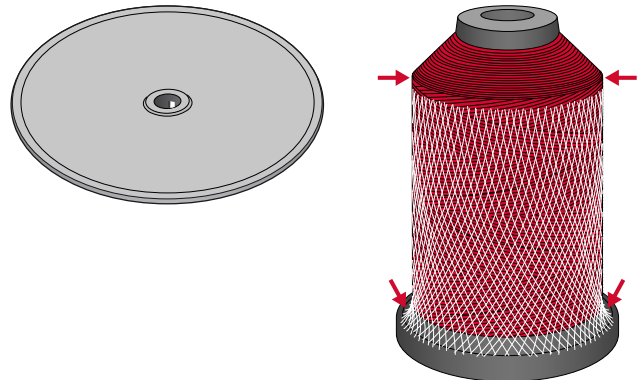

### If the thread tangles or curls when unwinding from the spool

For smaller spools of specialty thread, the main spool pin can be used in tilted position, allowing the thread to roll off the spool.

Place the thread spool on the spool pin. Do not place a spool cap on top of the spool as it may prevent the spool from rotating. Pull thread up to the telescopic thread guide and thread as described under [Threading the Upper Thread](#), page 30.

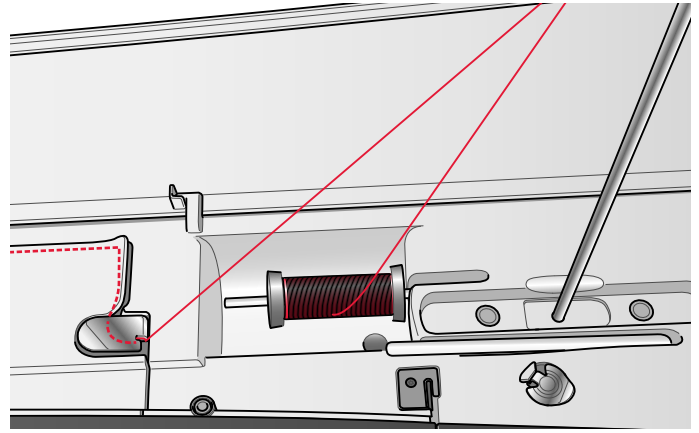

### Threading for Twin Needle

Replace the sewing needle with a twin needle. Make sure that the presser foot and needle are in the up position.

1. Raise both spool pins to vertical position. Place a thread spool on each spool pin. Using both hands, place the thread from the main spool pin behind the left clip on the telescopic thread guide (A), from right to left, and then place the thread from the auxiliary spool pin behind the right clip on the telescopic thread guide (B), from right to left.

*Note: Do not place the thread from the auxiliary spool pin behind both clips on the telescopic thread guide, as this will create too much thread tension.*

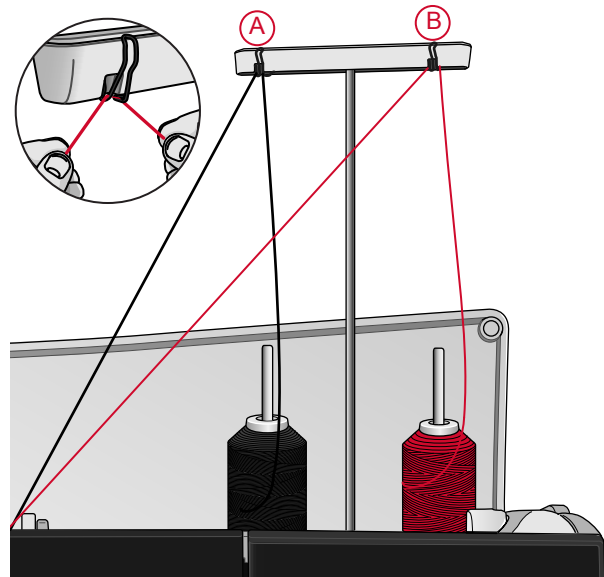

*Note: When using large thread cones on the auxiliary spool pin, place the large spool holder with the flat side up and a cone holder on the spool pin before adding the thread cone.*

2. Hold both threads with two hands as illustrated. Floss the threads under the thread guide (A) from front to back. Pull the threads together back into and through threading slot (B).

*Note: Continue to hold the threads lightly next to the thread guide (A) throughout the threading process. This will create a bit of tension on the threads and ensure that the threads are properly seated in the threading path.*

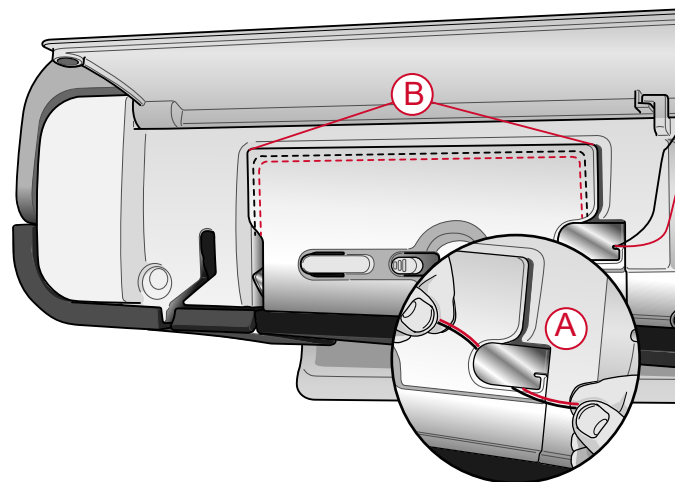

3. Pull the threads between the thread tension discs (C). Make sure that you place one thread to the left and one to the right of the tension discs. Thread down through the right threading slot and then upwards through the left threading slot. Bring the threads from the right into the take-up lever (D) until they click into place (E), and down in the left threading slot. One thread should be placed inside the needle thread guide (F) and the other one outside. Make sure the threads do not become twisted together.
4. Thread the twin needle manually.

 Do not use the automatic needle threader for twin needle!

*Note: The weight and irregular surface of specialty threads such as metallic increases the amount of friction on the thread. By reducing the tension, the risk of needle breakage and thread breakage is reduced.*

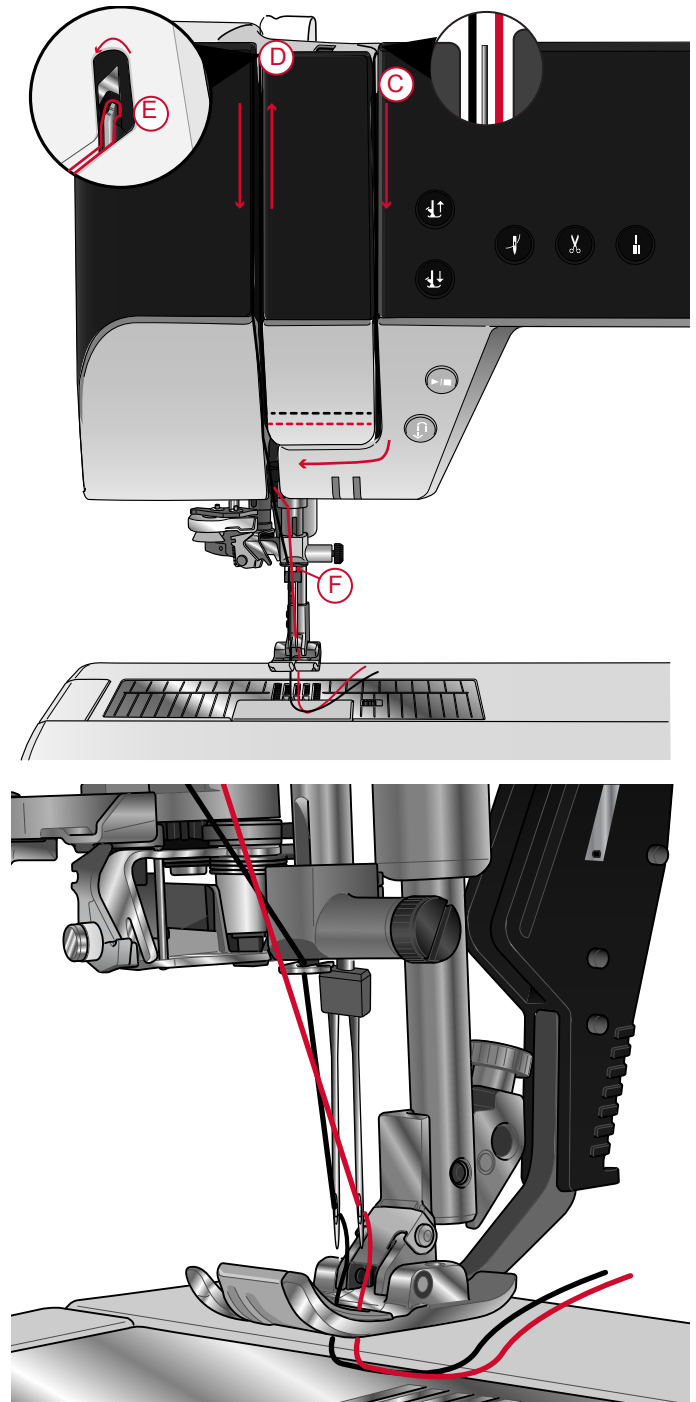

# Bobbin Winding

All types of thread, including specialty threads such as invisible or other stretchy threads, metallic or flat metallic threads, should be wound directly from the auxiliary spool pin without passing the needle and presser foot.

*Note: Always wind specialty threads at lower speed.*

1. Place a thread spool on the auxiliary spool pin. Using both hands, pull the thread behind the right clip on the telescopic thread guide (A). The thread should run from right to left.

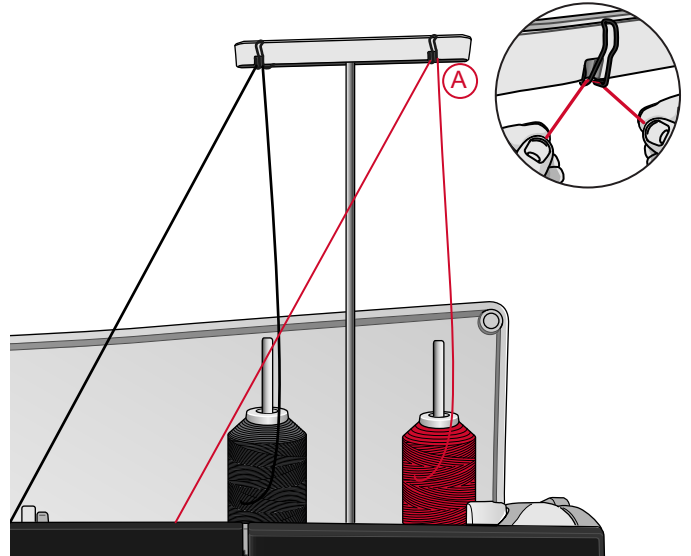

2. Bring the thread through bobbin winding thread tension guide (B) from back to front and to the left. Bring the thread through bobbin winding thread guide (C) as illustrated.

 For some specialty threads, following the normal threading path will result in a bobbin that is wound too tight. If this happens, bypass thread tension (B) to reduce the amount of tension on the thread. Pull the thread from thread guide (A) directly to the bobbin instead.

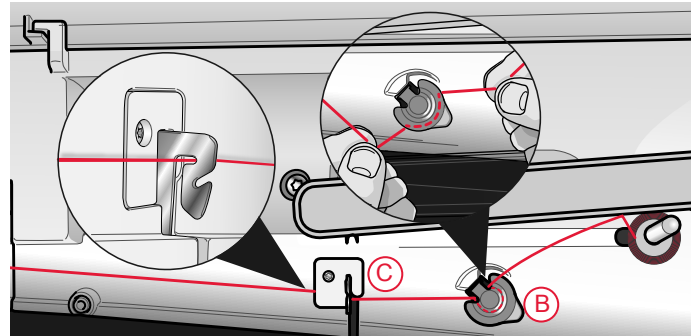

3. Thread through the slot in the bobbin (D) from the inside to the outside. Place the bobbin on the bobbin spindle (C). The bobbin only fits on one way, with the logo facing out.

 The bobbins included are designed especially for your performance icon™ machine. Do not use bobbins from other machine models.

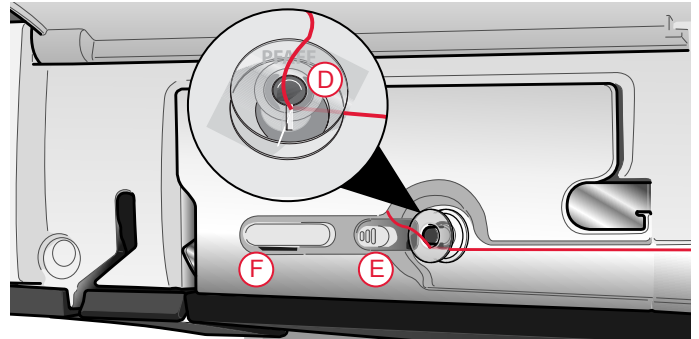

4. Push the bobbin winding lever (E) towards the bobbin. A pop-up appears on screen. To adjust winding speed drag the slider. Hold the thread end firmly when starting to wind. Touch the play button in the popup window and let the thread wind a few turns. Touch the pause icon and cut the loose thread end close to the bobbin. Press play again.
5. When the bobbin is full, the bobbin winding lever will move back and the winding will stop automatically. The pop-up message closes. Remove the bobbin and cut the thread using the bobbin winding thread cutter (F).

## Winding Through the Needle

When using the same thread in the needle and bobbin, it is convenient to wind a new bobbin directly through the needle without having to unthread/re-thread your machine.



*We do not recommend winding speciality threads such as invisible or other stretchy threads, metallic or flat metallic threads through the needle. Very heavy and coarse threads should not be wound through the needle either as the thread tension can become too high, causing the needle to break. Wind specialty threads as described under [Bobbin Winding](#), page 37.*

1. Make sure that the presser foot and needle are in the up position.
2. Thread the machine as described under [Threading the Upper Thread](#), page 30.
3. Pull the thread from the needle, under the presser foot and up to the right.

*Note: Always use a metal presser foot when bobbin winding from the needle.*

4. Use both hands to bring the thread through bobbin winding thread guide (A), up through the threading slot and from left to right through thread guide (B).
5. Thread through the slot in the bobbin (D) from the inside to the outside.  
Place the bobbin on the bobbin spindle. The bobbin only fits on one way, with the logo facing out.



*The bobbins included are designed especially for your performance icon™ machine. Do not use bobbins from other machine models.*

6. Push the bobbin winding lever (E) towards the bobbin. A pop-up appears on screen. To adjust winding speed drag the slider. Hold the thread end firmly when starting to wind. Touch the play button in the popup window and let the thread wind a few turns. Touch the pause icon and cut the loose thread end close to the bobbin. Press play again.

*Note: Always use a metal presser foot.*

7. When the bobbin is full, the bobbin winding lever will move back and the winding will stop automatically. The pop-up message closes. Remove the bobbin and cut the thread using the bobbin winding thread cutter (F). Cut the free thread end close to the bobbin.

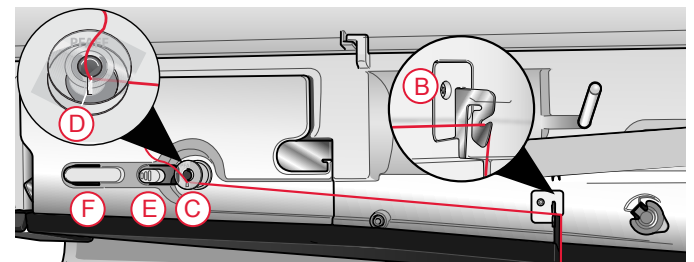
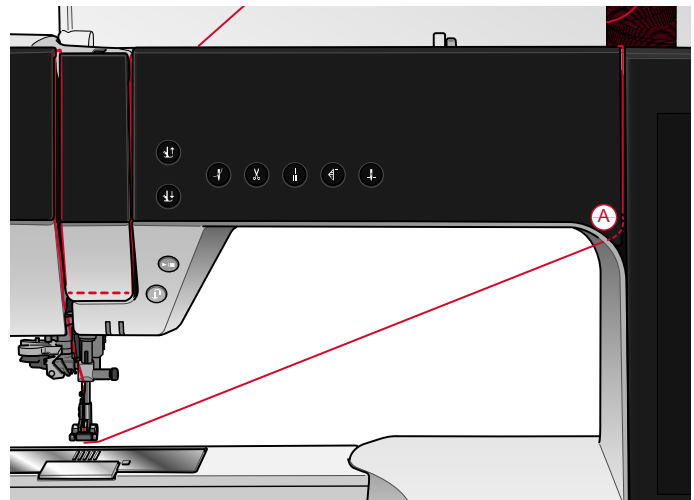

## Inserting the Bobbin



Use only the bobbins designed for your performance icon™ machine.

1. Open the bobbin cover by pushing the release button (A) to the right. Remove the cover.
2. Place the bobbin in the bobbin case. It drops in only one way with the logo facing up. The bobbin will then rotate counterclockwise when you pull the thread.
3. Place your finger on the bobbin to keep it from turning as you pull the thread firmly to the right and then to the left into the tension spring (B) until it “clicks” into place. Continue threading around (C) and to the right of the thread cutter (D).
4. Replace the bobbin cover. Pull the thread to the left to cut.

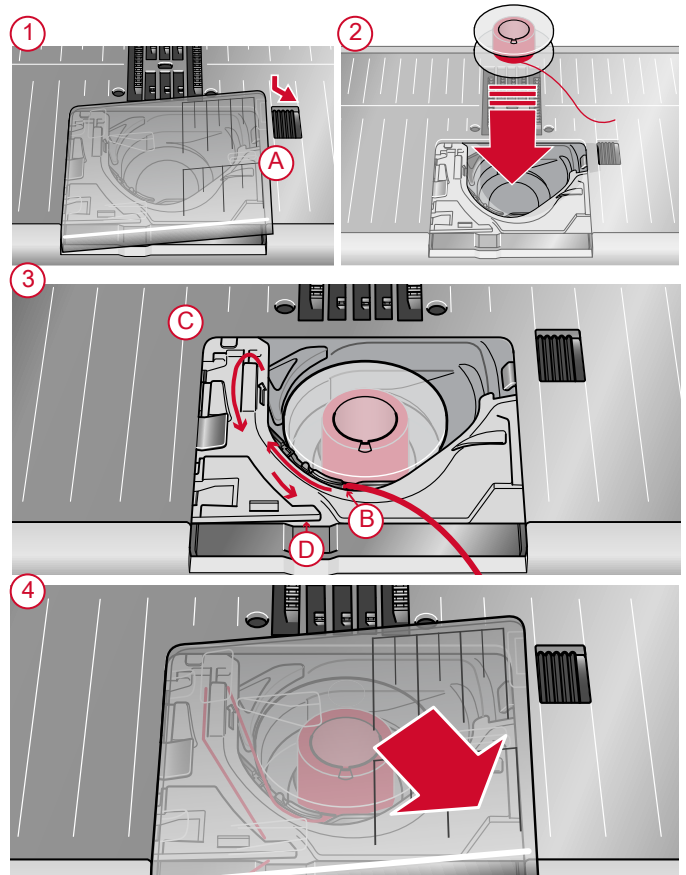

## Changing the Bobbin Case

The performance icon™ comes with two different bobbin cases. Bobbin case (1) is mounted on the machine at delivery and is used for most sewing. The second bobbin case (2), is the Straight Stitch Bobbin Case. This bobbin case is recommended to use when sewing a straight stitch that has moved its needle position to the left. A symbol will be shown in the information area on your screen when the Straight Stitch Bobbin Case is recommended.

1. Remove the presser foot. Open the bobbin cover by pushing the release button (A) to the right. Remove the cover.
2. Place the screwdriver under the needle plate as shown and gently turn the screwdriver to pop off the needle plate.
3. Remove the bobbin case holder (B) covering the front part of the bobbin case by lifting it up. Remove the bobbin case (C) by lifting it up.
4. Replace the bobbin case (D) and place the bobbin case holder (E) back in place. Attach the needle plate.

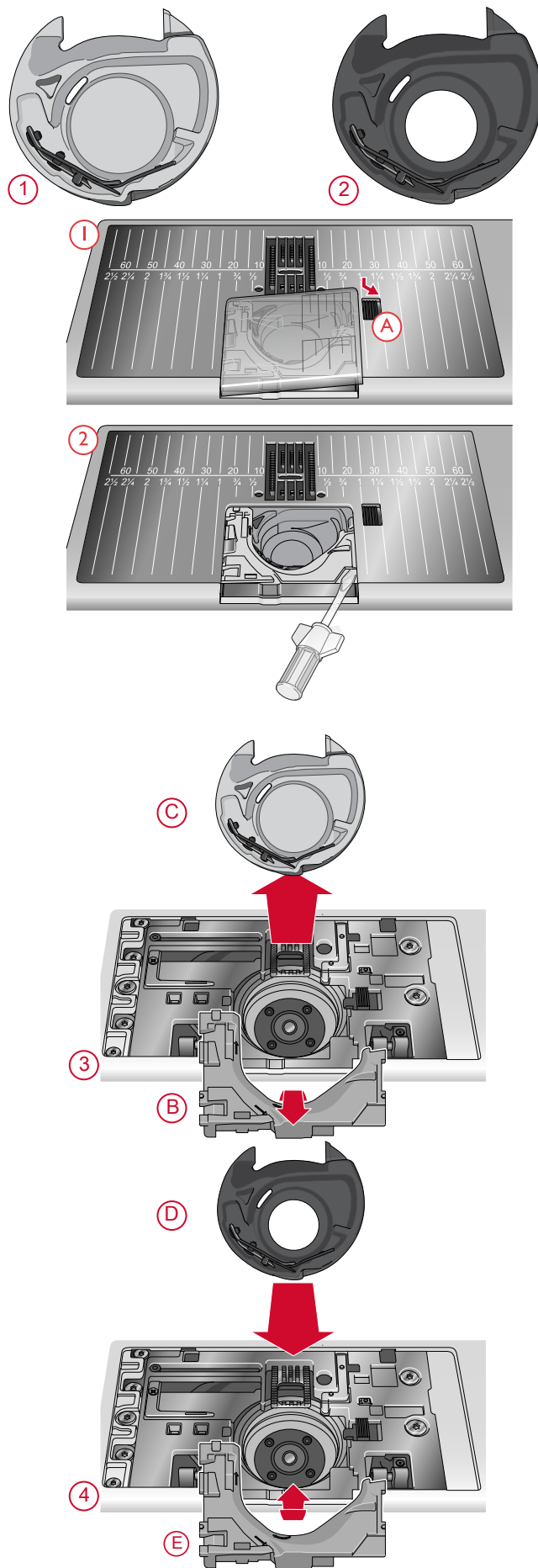

## IDT™ System (Integrated Dual Feed)

For sewing any fabric precisely, the PFAFF® performance icon™ machine provides the ideal solution: the integrated dual feed, IDT™ system. As on industrial machines, the IDT™ system feeds the fabric from the top and bottom at the same time. The material is fed precisely, eliminating puckering on seams in light weight fabrics such as silk and rayon. The dual feed action of the IDT™ system prevents layers from shifting while sewing, keeping quilt layers aligned and ensuring a more perfect match when sewing plaid or striped fabrics.

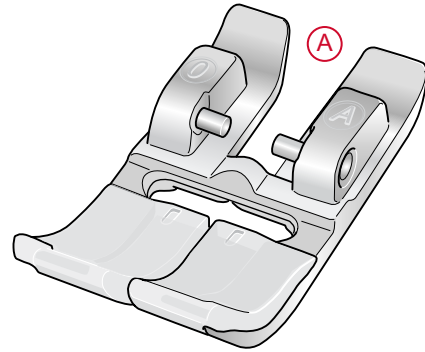

### Engaging the IDT™ System

Important: For all work with the IDT™ system, use presser feet with the center back cut-out (A).

Raise the presser foot to extra high position. Press the IDT™ system down until it engages.

*Note: Your machine is equipped with an IDT™ sensor which will alert you if you should engage the IDT™.*

### Disengaging the IDT™ System

Raise the presser foot. Hold the IDT™ system with two fingers at the ribbed ankle. Pull the IDT™ system down, then pull it away from you to release the IDT™ system slowly upward.

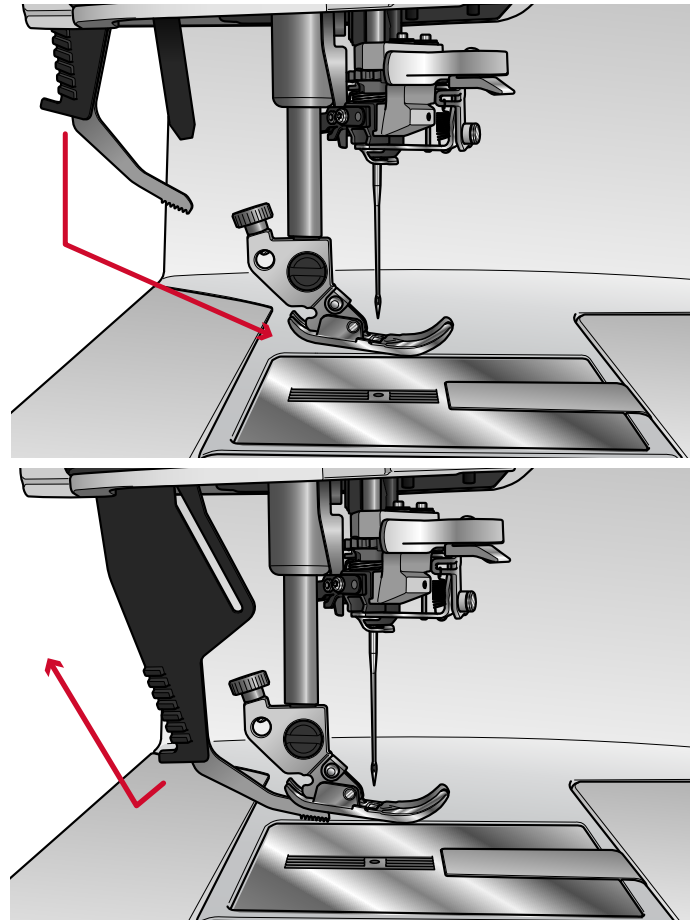

## Changing the Presser Foot

### Remove Presser Foot

Press the presser foot downwards until it disengages from the presser foot holder.

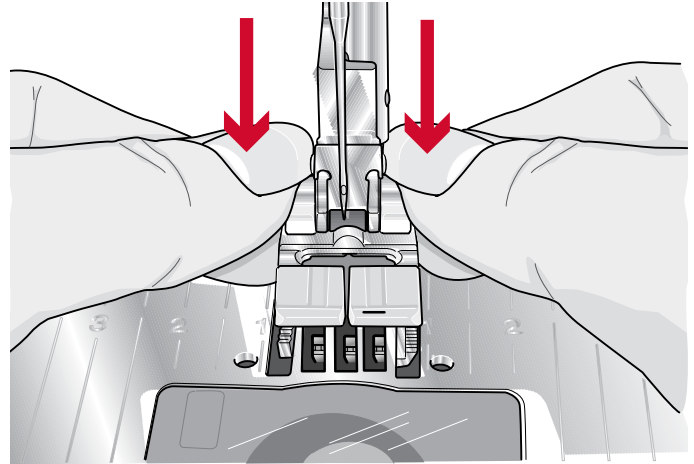

### Attach Presser Foot

Line up the pins on the foot with the gap underneath the presser foot holder. Press upwards until the foot snaps into place.

You can also use the presser foot up/down buttons to raise or lower the presser foot holder. Place the presser foot under the presser foot holder, so that the pins of the foot snap onto the presser foot holder when lowered.

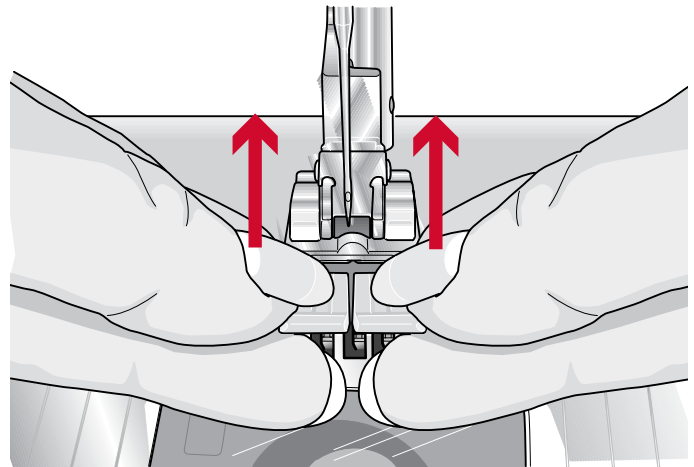

## Attaching the Sensormatic Buttonhole Foot

1. Snap on the Sensormatic Buttonhole Foot.
2. Insert the plug, with the three dots facing out, into the accessory socket at the back of the sewing head.

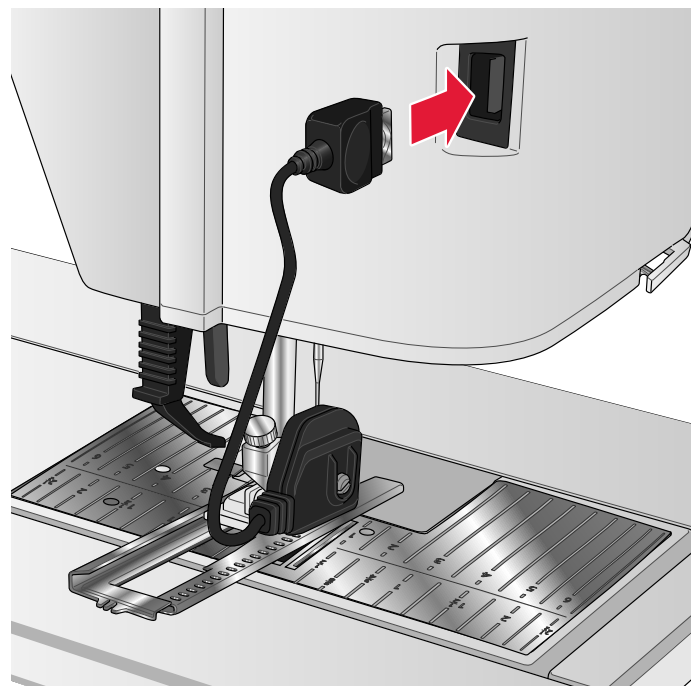

## Changing to Straight Stitch Needle Plate

The Straight Stitch Needle Plate is used for certain techniques in sewing mode, such as quilt piecing. The smaller hole in the Straight Stitch Needle Plate supports the fabric closer to the needle and helps prevent the fabric from being pulled down into the bobbin area, especially at the beginning and/or end of a seam.

1. Remove the presser foot. Open the bobbin cover by pushing the release button (A) to the right. Remove the cover.
2. Make sure that the feed teeth are lowered. Place the screwdriver under the needle plate as shown and gently turn the screwdriver to pop off the needle plate.

*Note: Lower the feed teeth by touching the presser foot up and extra lift button.*

*Note: When changing the needle plate, clean any lint and threads from the bobbin area.*

3. With feed teeth lowered, position the Straight Stitch Needle Plate so that it fits into the notches at the back. Press the Straight Stitch Needle Plate down (B) until it clicks into place. Replace the bobbin cover.



*To prevent needle breakage or damage to the plate, remove any accessory that is not compatible with the Straight Stitch Needle Plate, such as twin needle.*

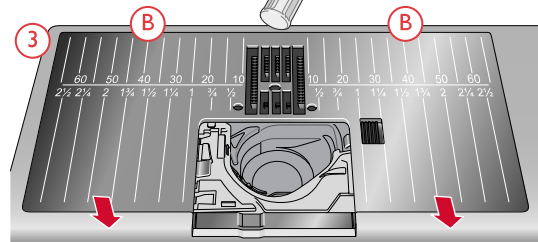
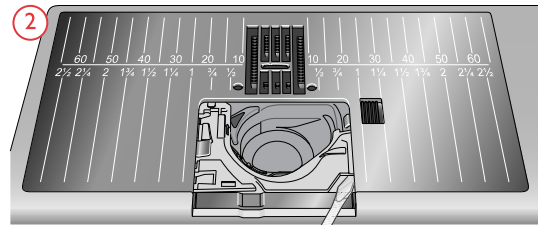
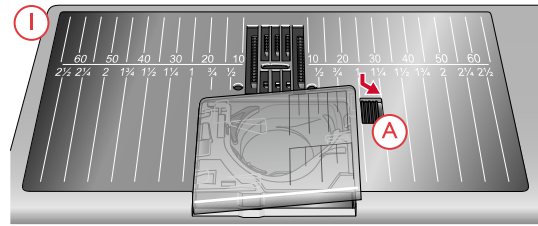

# 3 The Multi-Touch Screen

## Multi-Touch Screen

Your performance icon™ machine features a Multi-Touch Screen which is very easy to use. A few simple gestures – touch, touch & hold, pinch/stretch, touch and move and swipe – are all you need to use the Multi-Touch Screen.

### Gestures

#### Touch

Touch once on an icon or setting on the screen to select.

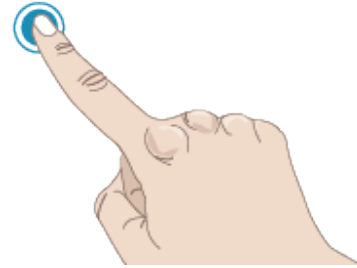

#### Touch & Hold

Touch once without releasing for a few seconds to touch & hold. Used on some buttons and screen areas to access more options.



#### Pinch/Stretch

Touch with two fingers at the same time and without releasing increase/reduce the distance between the fingers to stretch (zoom in) or pinch (zoom out).

This function is very useful when reading your user's guide to zoom in texts and pictures.

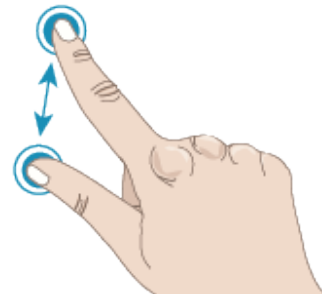

#### Touch and Move

Touch once and without releasing move your finger to a different position on the screen to touch and move.

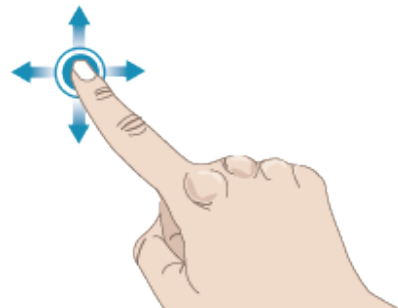

## Swipe

Touch, move and release your finger in a swift gesture to swipe. Left-right/right-left swipe is used e.g. to scroll between stitch menus. Top-bottom/bottom-top swipe is used e.g. to scroll within a stitch menu.

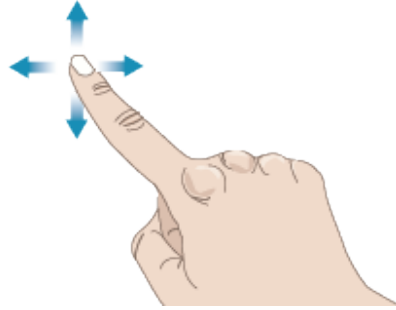

## Start Page

You can go to Sewing Mode directly from the Start Page. The Start Page is shown every time you start your performance icon™ machine. The Start Page is always accessible through the [Home button](#).



Home button

## Start Sewing

Touch to open Sewing Mode. You can also touch & hold to open the Selection Menu and select a stitch.

Read about how to get started sewing in the [Sewing chapter](#).



## Load From mySewnet™

Touch Load from *mySewnet™* to enter File Manager and *mySewnet™* cloud folder.

Read about *mySewnet™* cloud folder in the [File Manager chapter](#).



## Open Help Center

Touch to open the Help Center. This is where you will find the built-in User's Guide, Getting Started, Techniques and Tutorials, Sewing Instructions and Stabilizer Guide.

Read about Help Center in the [Help Center chapter](#).

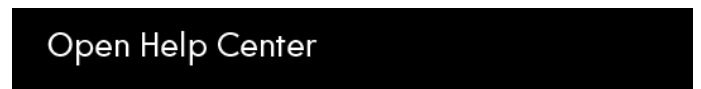

## mySewnet™ Blog

Touch this tab to open the mySewnet™ Blog where you can view the latest product news, sewing instructions and get inspiration!

Touch on a post to get more info on that specific project.

The machine needs to be connected to the internet to be able to see the feed.

## Main Functions

The Main Functions; Save, Home and Mode Switch are located just below the Multi-Touch Screen and are always accessible.

### Save

Touch to save your stitch or sequence at anytime.



### Home

Touch to return to the Start Page.



### Mode Switch

Touch to switch between Sewing Mode and to start a new sewing session.



## Common Functions

The following functions on the screen are used frequently.

### OK

Confirms changes and pop-up messages and returns to previous window.



### Cancel

Cancels changes and pop-up messages and returns to previous window.



### Touch & Hold

Some icons have additional functions, marked with an arrow at the lower right corner. To access those functions, touch & hold on the icon for a few seconds.



## Settings with Toggle Function

For some settings, two green dots are visible underneath the settings icon. It means you can toggle between two settings in the same control.



## Help Center

The Help Center is always close at hand. Touch the Help Center icon to enter the User's Guide, Getting Started, Techniques and Tutorials, Sewing Instructions and Stabilizer Guide.

## User's Guide

Touch to access your machines complete User's Guide. The User's Guide contains all the information about your performance icon™ sewing machine.

## Getting Started

Touch to view Quick Start Guide. Some of the guides will show animations.

## Techniques and Tutorials

Touch to view projects that have a step-by-step instruction on how to sew specific sewing techniques.

## Sewing Instructions

Touch to view complete sewing instruction projects.

## Stabilizer Guide

Touch to read instructions on how to use different stabilizers.

Help Center

User's Guide

Getting Started

Techniques and Tutorials

Sewing Instructions

Stabilizer Guide

# Settings

Here you will find tabs for Sewing Settings, Machine Settings etc. Just swipe between the tabs and make settings for your performance icon™ machine.

## Sewing Settings

There are two ways to change your settings;

### 1. Default Settings:

Settings made in Default Settings will be saved, even when turning your machine off. The Default Settings becomes active when you start a new session or restart your machine.

### 2. Temporary Settings:

Settings made in Temporary Settings will be reset at the start of a new project in Help Center or start of a new sewing session. When turning your machine off, all changes made in Temporary Settings will be reset to default.

## ActivStitch™ Technology

When the **ActivStitch™** technology feature is selected your machine will automatically choose the best way to control the upper thread, by thread metering or thread tension, based on your selected stitch and settings. Thread metering automatically and continuously measures the fabric thickness to meter the correct amount of thread for the selected stitch. When using thread tension, the tension discs will keep the correct amount of tension on the upper thread.

For best results we recommend you keep this setting selected except when using specific accessories or special techniques that do not support thread metering.

Deselect the **ActivStitch™** technology feature in the Temporary Settings to switch to thread tension. The control for adjusting thread metering/thread tension, will change depending on the active stitch and whether the **ActivStitch™** technology feature is selected or not in Temporary Settings.

[Read about ActivStitch™ technology in the Sewing chapter.](#)

## Automatic Presser Foot Lift

When selected, the machine automatically raises the presser foot in the following situations:

- When stopping with the needle in the down position the presser foot will automatically raise to pivot height.
- After a thread cut the presser foot will be raised to lift position.

When deselected, the presser foot will stay lowered, even if the machine stops with the needle in down position.



1. Default Settings in white colored check boxes
2. Temporary Settings in orange colored check boxes

## Automatic Thread Cutter

When selected, the threads are cut automatically in the following situations:

- At cut commands in stitches and sequences.
- After sewing a single stitch e.g. a monogram or eyelets.

If deselected, no automatic thread cut will be performed.

*Note: Deselect when using optional accessories that are attached in the two holes in the needle plate just above the bobbin cover, to prevent damage to the automatic thread cutter knife located under the needle plate.*

## Free-Motion Options

Choose between three Free-Motion Options; Dynamic Spring Foot 6D Free-Motion, Spring Foot Free-Motion and Sensormatic Free-Motion. When one of the Free-Motion Options is selected the corresponding Free-Motion mode will automatically be selected in the Temporary Settings for all new projects or sewing sessions.

It is recommended that you do not set an option for free-motion in the Default Settings; touch the Free-Motion icon in Sewing Mode to choose a temporary option instead.

For more information see the description in the [Free-Motion Options in Sewing Mode](#).

## Stitch Limiting Options

Set the machine to Stitch Width Safety or select the size of the twin needle to limit the stitch width and stitch positioning. This will minimize the risk of breaking a needle when sewing with accessories that do not allow the use of the entire stitch width.

## Needle Stop Position

When Up is selected your machine stops with the needle up. When Down is selected your machine stops with the needle down.

This setting can also be set by touching the Needle Up/Down button on the front of the machine.

## Presser Foot Pressure

In most cases, you do not need to adjust the presser foot pressure. Specialty techniques may require an adjustment. The higher the number the more pressure on the fabric.



*Free-Motion Options*



*Stitch Limiting Options*



*Needle Stop Position*



*Presser Foot Pressure*

## Options for Feed Dogs

When auto is selected (recommended) your machine automatically raises or lowers the Feed Dogs, depending on the stitch and other selected settings. For example, the Feed Dogs are lowered when sewing on buttons or when free-motion sewing.

Select Up and the Feed Dogs will be raised for all sewing. Select Down and the Feed Dogs will be lowered for all sewing.

*Note: The machine will always lower the Feed Dogs automatically when raising the presser foot to extra lift position.*

*Note: The Feed Dogs options will automatically be reset to auto at the start of a new project from the **Help Center**.*

## Tie-Off Options

These options let you program a Tie-Off at the beginning and at the end of a stitch. It is also possible to program a thread cut at the end of a stitch.

*Note: For immediate Tie-Off, use the Tie-Off button, found on the front of the machine.*

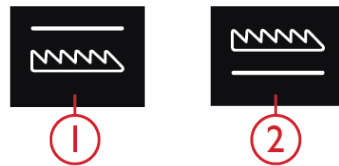

1. Feed Dogs Lowered

2. Feed Dogs Up



Tie-Off Options

## Machine Settings

All settings made in the machine settings will be saved, even when turning your machine off.

### Language

Select your desired language. All texts in your machine will be changed after restart.

### Audio Volume

Change the audio volume using the slider bar. All sounds in your machine will be affected when the audio volume is changed. When the slider is all the way to the left, the volume is muted.

### Audio Repeat

When active, the signal for some warning alerts or attention pop-up messages will be repeated in intervals until the pop-up is closed.

### Machine Nickname

Touch to select a nickname for your machine. This can be useful when owning more than one machine, to distinguish one machine from another when working in mySewnet™. The name will be shown on the screensaver.

### Lock Screen

When selected, the screen is automatically locked whenever it is inactive for ten seconds. A pop-up is shown on the screen and the screen will remain locked until you touch OK in the pop-up.

### Units

Touch millimeter or inch to set the measurement unit you prefer.

### LED Work Light Brightness

Adjust the brightness of the LED lights to adapt to the light conditions in your sewing room. Simply move the slider to the right to make the LED lights brighter or to the left to make them less bright.

### Background Image

Customize your performance icon™ machine by selecting the background image options.

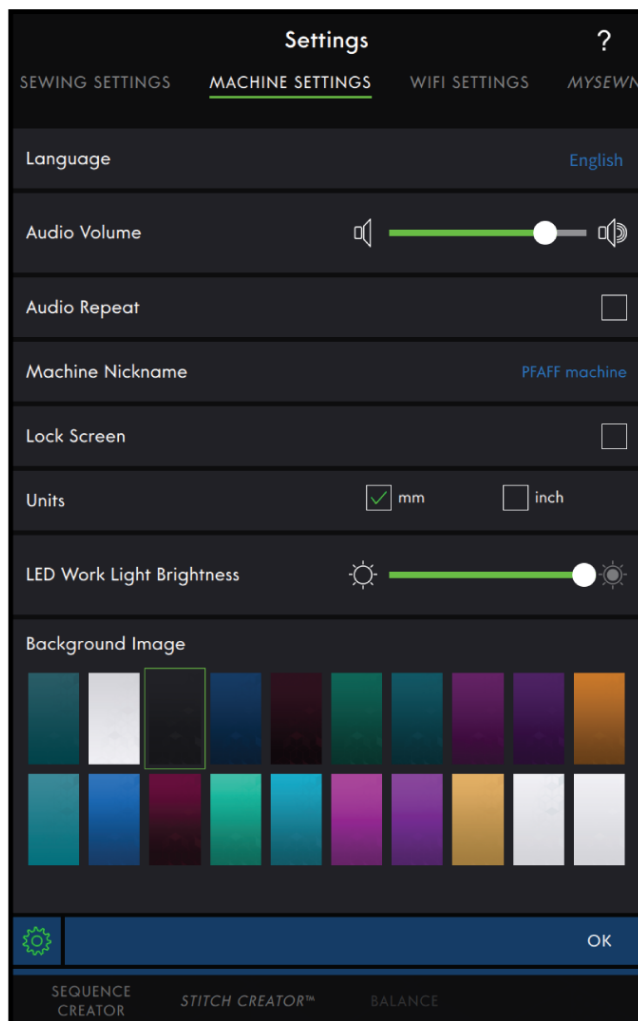

## WiFi Settings

In WiFi settings you can activate/deactivate WiFi on your machine, search for available networks and connect. If connected to a network with Internet access the latest firmware update will always be available. When WiFi is connected and you have logged in to the *mySewnet*<sup>TM</sup> cloud, all your saved files in the machine will synchronize with the *mySewnet*<sup>TM</sup> cloud.

Read more about the WiFi connection in your machine in the [WiFi chapter](#).

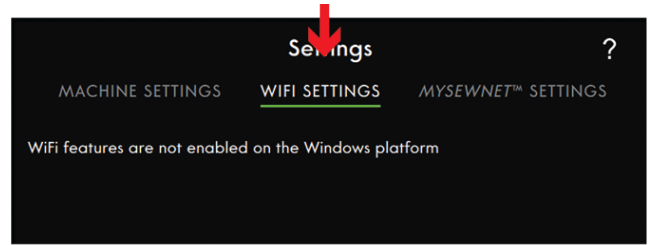

## mySewnet<sup>TM</sup> Settings

In the *mySewnet*<sup>TM</sup> Settings you can sign in to the *mySewnet*<sup>TM</sup> cloud or, change the user. You will also be able to create a new user. With a *mySewnet*<sup>TM</sup> account you will be able to access all of the *mySewnet*<sup>TM</sup> services.

Read about [mySewnet<sup>TM</sup> services](#).

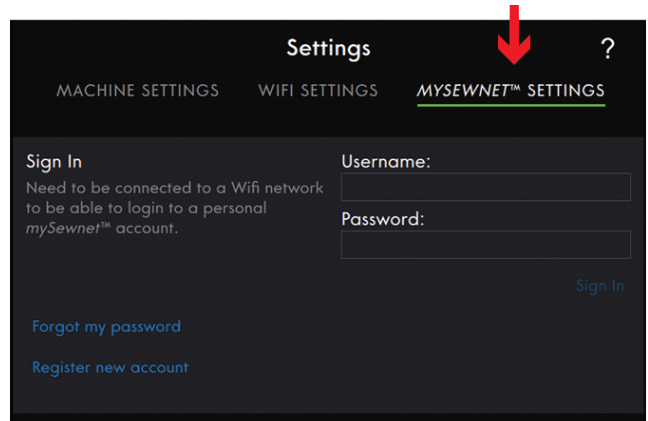

## Machine Information

Machine information contains technical machine information such as: machine serial number, machine MAC address and current firmware. In machine information you can clear user account and files.

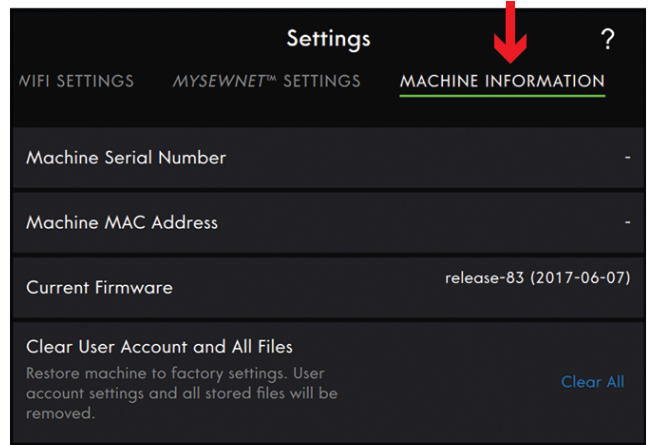

## Smart Toolbox

The Smart Toolbox is available in the sewing area. Touch & hold anywhere in your work area to open the Smart Toolbox and select the option you want.

The options included in the Smart Toolbox differ depending on where they are used.

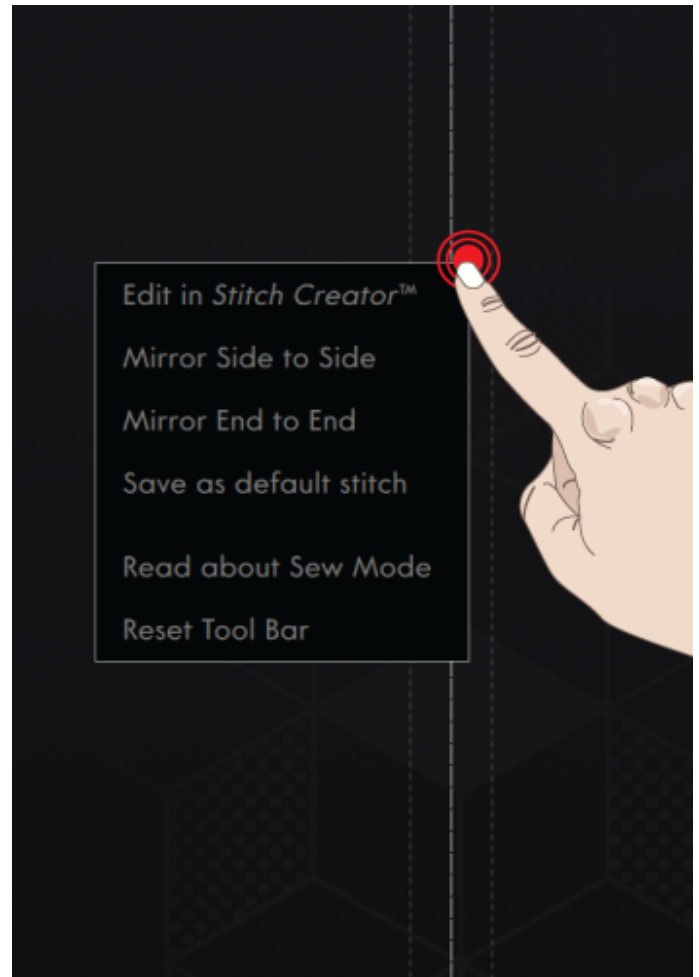

## Top Bar

The Top Bar shows which mode you are in. It includes the [Help Center](#), [Quick Help](#) and [Main Menu](#).

1. Help Center
2. Quick Help
3. Main Menu

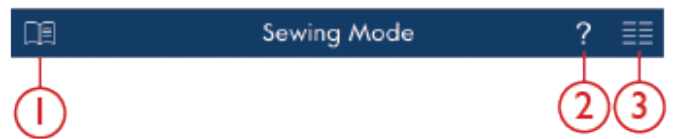

## Help Center

Touch the Help Center icon to enter the Help Center. Here you will find the built-in User's Guide, Getting Started, Techniques and Tutorials, Sewing Instructions and Stabilizer Guide. Read more in the [Help Center chapter](#).



## Quick Help

Touch the question mark icon to open Quick Help. The icon becomes highlighted in green and flashes indicating that Quick Help is active. Touch an icon or an area on the screen you want information about. A pop-up will appear giving you a short text about the icon or area. Touch OK to close the pop-up and exit Quick Help.

Some Quick Helps will refer to the Built-in User's Guide for more information. Touch the text to open the chapter in the User's Guide.



## Main Menu

Touch Main Menu and select one of the tabs; Selection Menu or File Manager.



## Selection Menu

Touch the Selection Menu tab to open Select Stitch, Select Design or Select Font.

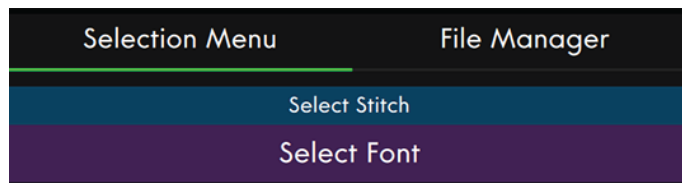

## File Manager

Touch the File Manager tab to open font files and stitch files. Store your saved files in the *mySewnet*™ cloud folder, or to a USB device connected to your machine.

Read about loading and organizing your saved stitches and fonts in the [File Manager chapter](#).

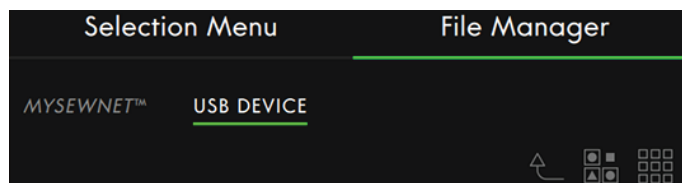

## Information Area

The Information Area gives you information about your WiFi, recommendations for your stitch, selected stitch and activated features made in Temporary Settings.

Each menu in the Information Area can be collapsed and expanded by touching the arrow.

You can hide the entire Information Area by swiping to the left. Touch the information icon to show the Information Area again.

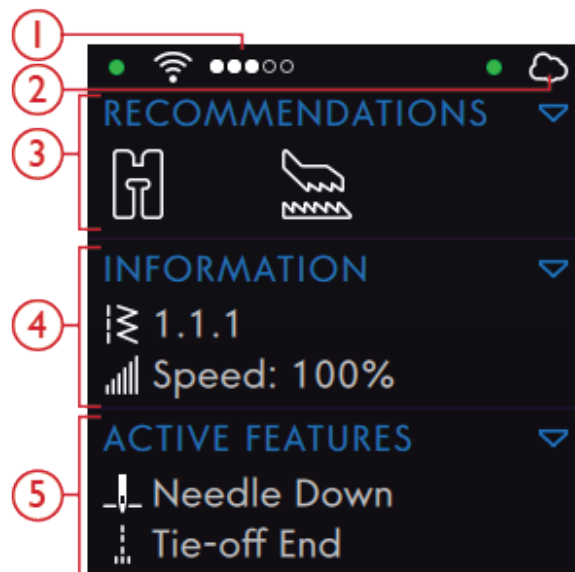

1. WiFi Signal Strength
2. *mySewnet*™ cloud
3. Recommendations
4. Information
5. Active Features

## WiFi

Touch the WiFi icon to access the WiFi Settings. Select a network from the list of available networks. If your network is password protected, you will be prompted to enter the password.

If you do not get any signal or have a low signal strength see [Troubleshooting](#).

Read about WiFi in your machine in the [WiFi chapter](#).



- |  |   |
|--|---|
| 1. Indicates WiFi Status                   | 5. Firmware Update Available                      |
| 2. WiFi                                    | 6. Indicates <i>mySewnet</i> <sup>TM</sup> Status |
| 3. WiFi Signal Strength                    | 7. <i>mySewnet</i> <sup>TM</sup> cloud            |
| 4. Firmware Update Waiting To Be Installed |   |

## *mySewnet*<sup>TM</sup>

After connecting to WiFi, touch the *mySewnet*<sup>TM</sup> Settings tab, or touch *mySewnet*<sup>TM</sup> cloud icon in the Information Area. Sign in to *mySewnet*<sup>TM</sup> account or create a new *mySewnet*<sup>TM</sup> account.

When signed in you will see how much available space there is in the *mySewnet*<sup>TM</sup> cloud.

The synchronization status will be shown with a green flashing dot in the Information Area.

If your machine can not connect to *mySewnet*<sup>TM</sup> cloud or does not synchronize, see [troubleshooting](#).

Read more about *mySewnet*<sup>TM</sup> cloud in the [mySewnet](#)<sup>TM</sup> chapter.

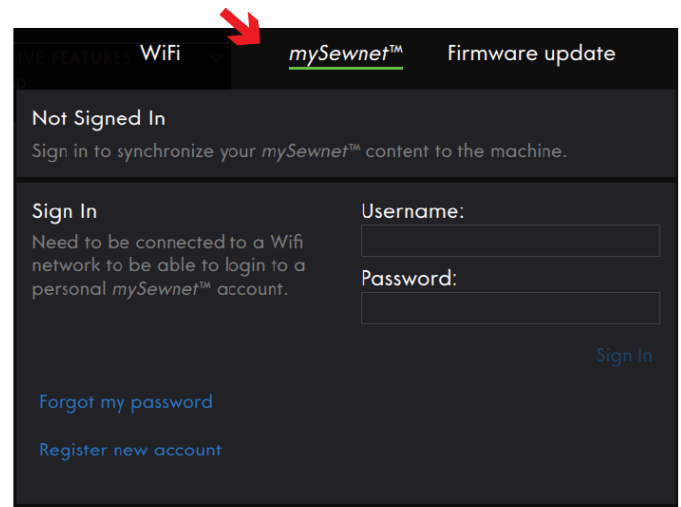

## Recommendations

Recommendations are only available in Sewing Mode. It shows recommendations for the selected stitch regarding presser foot, IDT<sup>TM</sup> system, stitch plate, bobbin case, and/or if stabilizer should be used. It also shows if you need to change the bobbin case. The Recommendations Menu can be both expanded and collapsed by touching the arrow. It is also possible to hide the entire information area by swiping to the left.

*Note: Touch the Information icon to show the information area again.*

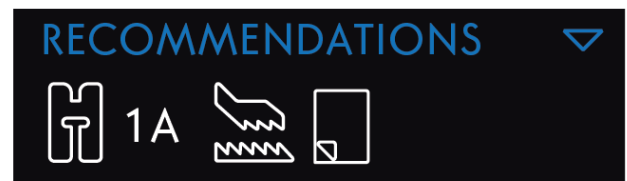

## Information

Shows the selected stitch number and the speed setting for selected stitch. The Information Menu can be expanded and collapsed by touching the arrow. It is also possible to hide the entire information area by swiping.

*Note: Touch the information icon to show the Information Area again.*

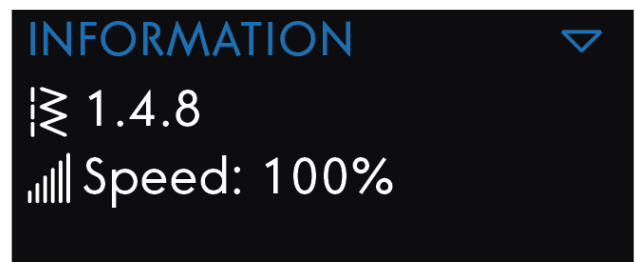

## Active Features

This section shows activated features, such as Tie-Off Options, needle down or changes you have made in the Temporary Settings. The Active Features Menu can be expanded and collapsed by touching the arrow. It is also possible to hide the entire Information Area by swiping.

*Note: Touch the Information icon to show the Information Area again.*



## Menu Panel

The Menu Panel differs depending on which mode you are in. The Menu Panel can be moved around on the screen. Simply touch & hold on the colored panel top to move the panel where you want it to be placed. Touch an icon in the panel to open a menu.

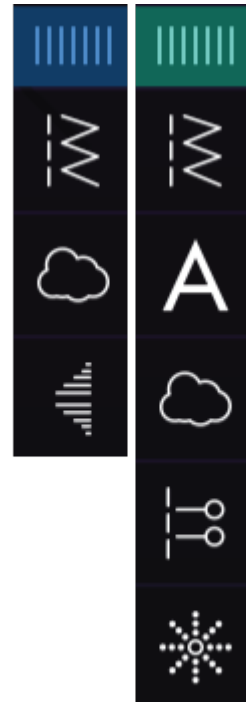

## Options Selected From the Menu Panel

Some menus contain more than is initially displayed. Swipe to browse categories in the window and/or expand the window to a size of your choice by touch and drag the colored triangle, in the lower corner of the window.

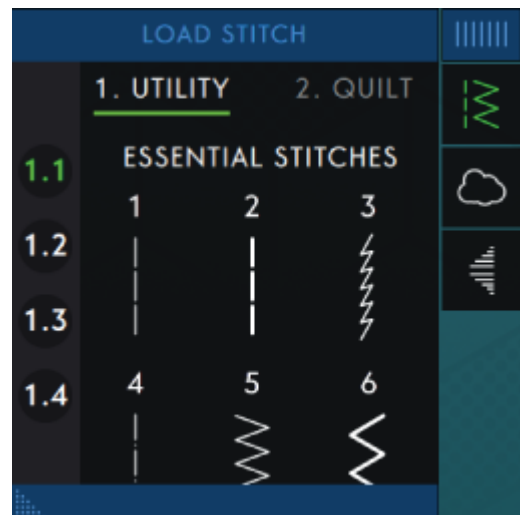

## Toolbar

The lower Toolbar will differ depending on which mode you are in. Touch one of the icons to open it.

When you have activated a function, e.g. Tie-Off the icon in the Toolbar will be highlighted and the active function will be shown under Active Features.

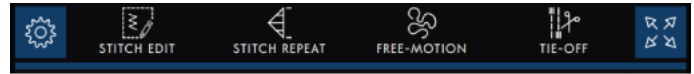

## Customize Your Work Area

The performance icon™ allows you to access the functions you use the most by arranging them as you desire on the screen. Touch the Detach icon to show which controls that can be moved around. Touch & hold the Move icon in the center until the control pop's up. Drag and drop it to desired location. Your machine will remember your changes when turning your machine off. Touch the x to close the control. To reset the Toolbar to default, use Smart Toolbox and select Reset Toolbar.

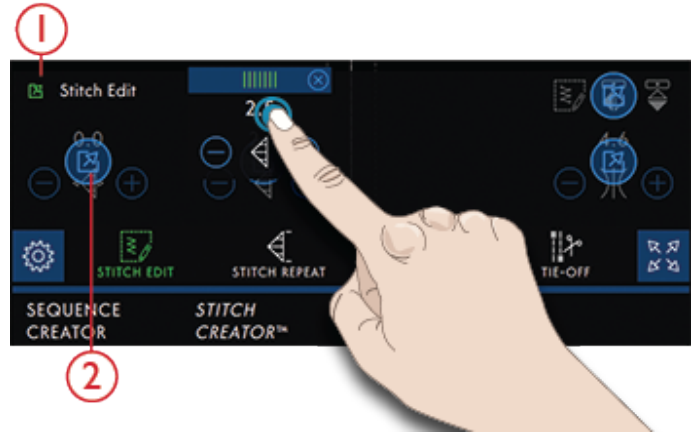

1. Detach
2. Move

## Full Screen View

Touch to toggle between full screen mode on/off.



## Base Bar



Functions that open full screen windows are placed in the very bottom of the screen.

## 4 WiFi & mySewnet™ Services

### WiFi Introduction

Your performance icon™ machine features WiFi, which makes it possible to connect your machine wireless to the mySewnet™ services.

### Getting Started With WiFi

Touch the WiFi icon in the Information Area to activate WiFi. Select a network from the list of available networks. If your network is password protected, you will be prompted to enter the password in the pop-up to be able to connect.

Touch the Information icon to open an information pop-up about the network. You can also see the signal strength and if the network is password protected, indicated with a closed padlock.

You can also connect to a network with WiFi in WiFi Settings.

If you do not get any signal or have a low signal strength see Troubleshooting.

### Hidden Network

Touch Hidden Network to connect to a Hidden Network. A pop-up will be shown on the screen where you can enter the name of the hidden network.

### Firmware Update Using WiFi

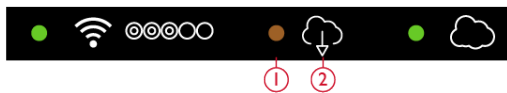

1. Firmware waiting to be downloaded. Only visible if you have chosen to download it later.
2. New firmware update available.

Your performance icon™ is a modern, updateable sewing machine. It is always recommended that you install the latest firmware in your machine. Firmware updates will always be to the benefit of the user and the product.

To be able to get the latest firmware you need to connect to a network using WiFi. When connected, your machine

will automatically search for an available Firmware Update. If the machine has detected that there is a newer firmware available, the firmware update icon will be visible in the information area. Touch the icon to open a pop-up to download and install the latest firmware. The installation of the new firmware will be shown with a green flashing dot in the Information Area.

If you choose to install the firmware later you will see a yellow dot in the Information Area, reminding you about the latest firmware ready to be installed.

When the update is completed the machine will restart automatically. Check the firmware version number in Settings, Machine Information.

### Firmware Update Using a USB Device

Visit the PFAFF® website from your computer at [www.pfaff.com](http://www.pfaff.com) and find your machine. This is where you will find any available updates.

You can also login to the mySewnet™ portal to find the firmware update.

1. Download the update firmware zip file. Unzip the file and copy the file (.clo) to a USB device.

*Note: Do not change the name of the file or do not copy the file into an existing folder on the USB device.*

*Note: Make sure that there is no old firmware update file (.clo) on the USB stick when copying the new firmware update file (.clo). The file name is not unique.*

2. Make sure that the machine is turned off. Connect the USB device loaded with the new firmware version to a USB port on your machine.
3. Press and hold the Reverse button, located on the front of the machine, and turn on your machine with the ON/OFF switch. Release the Reverse button when an update icon is shown on the screen.
4. The firmware update will be verified and installed. The machine may restart several times during the update process. Do not turn off the machine.
5. When the update is completed the machine will restart automatically. Check the software version number in Settings, Machine Information.

## mySewnet™ Services

Your performance icon™ machine features the *mySewnet™* services which contains the following:

- *mySewnet™* account – A personal login-based account to access the different *mySewnet™* services.
- *mySewnet™* cloud – A cloud based service where you will save and access your personal files from three different places: the *mySewnet™* cloud folder on the machine, the *mySewnet™* cloud sync tool on your

computer and the *mySewnet™* portal. From the *mySewnet™* cloud you will be able to view current machine status through the SewNotice app.

- *mySewnet™* portal – A website with different *mySewnet™* services such as register machines, edit personal user profile and manage files in the *mySewnet™* cloud.

## mySewnet™ Account

Start with registering a *mySewnet™* account to be able to use the *mySewnet™* services. You can create your account from *mySewnet™* icon or in [mySewnet™ settings](#).

Touch sign in and a pop-up will be opened where you can choose to register a new *mySewnet™* account.

A *mySewnet™* account can also be created through the *mySewnet™* portal at [pfaff.mysewnet.com](http://pfaff.mysewnet.com).

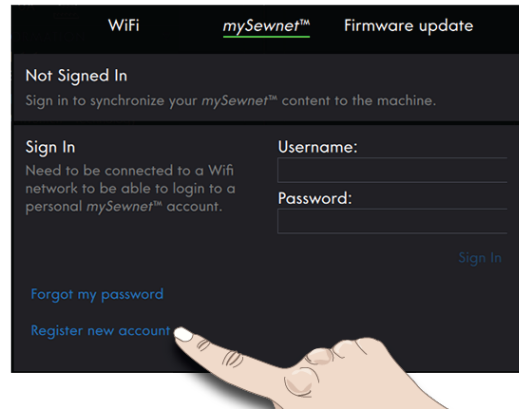

## mySewnet™ Cloud

The *mySewnet™* cloud is a service for hosting files in the cloud that is available to all owners and users of a *mySewnet™* cloud featured machine such as your performance icon™ machine. The *mySewnet™* cloud offers a simple way to manage and access personal files from three different places: the *mySewnet™* cloud folder on the machine, the *mySewnet™* cloud sync tool on your computer and the *mySewnet™* portal.

- *mySewnet™* cloud folder on the performance icon™ machine – In [File Manager](#) you will find the *mySewnet™* cloud folder where you store and synchronize your files to the *mySewnet™* cloud.
- *mySewnet™* cloud sync tool on your computer – Install the *mySewnet™* cloud sync tool on your computer to keep a local folder on your computer synchronized with the *mySewnet™* cloud.
- *mySewnet™* portal – Manage the files in the *mySewnet™* cloud through an ordinary web browser.

The synchronization status will be shown with a green flashing dot in the information area.

If your machine cannot connect to *mySewnet™* cloud or does not synchronize, see [Troubleshooting](#).

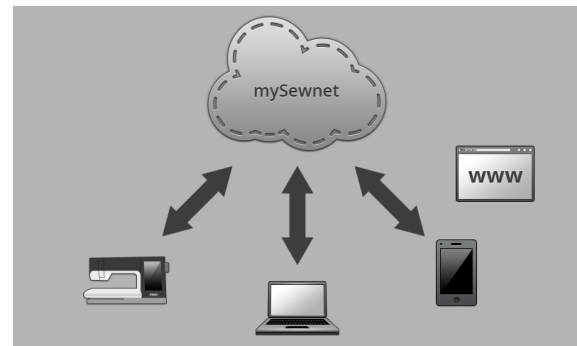

## Used Space in *mySewnet*<sup>TM</sup> Cloud

The *mySewnet*<sup>TM</sup> cloud will store fonts, stitches and other files from your machine.

Touch *mySewnet*<sup>TM</sup> on the topbar or go to *mySewnet*<sup>TM</sup> settings. When only a small amount of space is left, your machine will alert you once. If you continue to fill the space, it will not remind you again, until the space is completely full. Delete or move files to a USB device to free space.



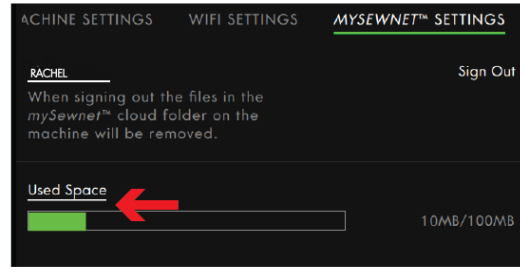

*Note: The mySewnet*<sup>TM</sup> cloud space gets activated the first time you sign in on your *mySewnet*<sup>TM</sup> account from the machine.



## Installation of *mySewnet*<sup>TM</sup> cloud Sync Tool for Computer

Install the *mySewnet*<sup>TM</sup> cloud sync tool to support synchronization of a local folder on your computer with the content stored in *mySewnet*<sup>TM</sup> cloud.

1. Download the synchronization tool to your computer from the *mySewnet*<sup>TM</sup> portal at [pfaff.mysewnet.com](http://pfaff.mysewnet.com).
2. On your computer, double click on the file *mySewnetCloudSyncSetup.exe* to run the setup wizard. Go through the steps in the setup wizard to install.
3. Once it is installed, you will see a *mySewnet*<sup>TM</sup> cloud sync folder on your hard drive. Add, modify or delete content in your *mySewnet*<sup>TM</sup> folder on your computer in order to add, modify or delete content in the *mySewnet*<sup>TM</sup> cloud folder on your performance icon<sup>TM</sup> machine.

	Signed in to <i>mySewnet</i> <sup>TM</sup> cloud.
	Synchronizing files with the <i>mySewnet</i> <sup>TM</sup> cloud.
	Not signed in to the <i>mySewnet</i> <sup>TM</sup> cloud sync tool.
	Cannot synchronize with the <i>mySewnet</i> <sup>TM</sup> cloud sync tool. Check the <u>used space</u> in the <i>mySewnet</i> <sup>TM</sup> cloud.

## Synchronize a File

Make sure that you are signed in to *mySewnet*<sup>TM</sup> account on your machine. Also make sure that the *mySewnet*<sup>TM</sup> cloud sync tool is installed and running on your computer.

1. Drag and drop the file into the *mySewnet*<sup>TM</sup> cloud folder on your computer.

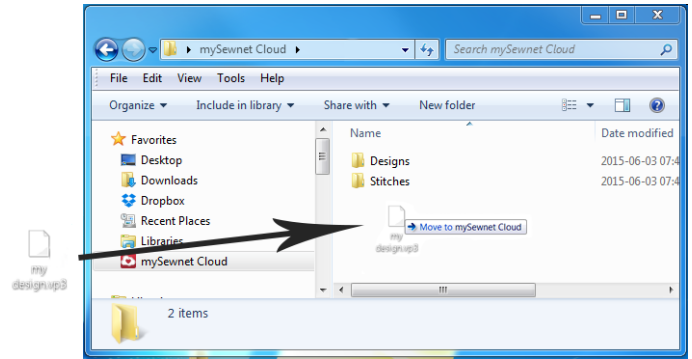

2. The icon is shown as long as the synchronization is progressing.
3. The icon means that your file has finished synchronizing and is now available from *mySewnet*<sup>TM</sup> cloud folder in file manager on your performance icon<sup>TM</sup> machine and also in *mySewnet*<sup>TM</sup> portal.



## *mySewnet*<sup>TM</sup> Portal

The *mySewnet*<sup>TM</sup> portal is a personal web page with access to the different *mySewnet*<sup>TM</sup> services. Login to the *mySewnet*<sup>TM</sup> portal with your *mySewnet*<sup>TM</sup> account. You can access the *mySewnet*<sup>TM</sup> portal at [pfaff.mysewnet.com](http://pfaff.mysewnet.com) to use the following services:

- My machines – Overview of your machines related material such as user's guide, sewing project inspiration, optional accessories information etc.
- My profile – Overview of your personal profile, with contact information, e-mail subscriptions, interest information and account details etc.
- *mySewnet*<sup>TM</sup> cloud – Possibility to manage your personal files. The files are automatically synchronized with the *mySewnet*<sup>TM</sup> cloud folder in the performance icon<sup>TM</sup> machine and the *mySewnet*<sup>TM</sup> cloud sync tool.

## Troubleshooting Connectivity

### The Machine Cannot Connect to a WiFi Network

The machine will not connect to a WiFi network	<p>Make sure that WiFi is enabled on your machine. Touch the <u>WiFi icon</u> in the Information Area to open <u>WiFi Settings</u>.</p> <p>Make sure that the machine detects a signal from your WiFi network. If there is no signal, move the machine closer to the WiFi router.</p> <p>Make sure you have selected your WiFi network.</p>
The machine has no Internet connection	<p>Make sure that your WiFi router has access to the Internet.</p>
The WiFi network is password protected	<p>Make sure that you have selected your WiFi network and entered the correct password. If you do not know the password, contact the administrator of your network.</p>

## The Machine Cannot Synchronize with the *mySewnet*<sup>™</sup> cloud

The machine cannot synchronize files with the *mySewnet*<sup>™</sup> cloud

Make sure that you have a working WiFi connection.

Make sure that you have signed in to your *mySewnet*<sup>™</sup> account. New *mySewnet*<sup>™</sup> accounts are registered in the machine or at [pfaff.mysewnet.com](http://pfaff.mysewnet.com)

Make sure that there is available space on the *mySewnet*<sup>™</sup> cloud.

If the *mySewnet*<sup>™</sup> cloud is not accessible although you have checked the WiFi connection, the server could temporarily be unavailable. Please try again later.

# 5 Sewing

## Sewing Mode – Introduction

In Sewing Mode you can select stitches, adjust and sew them. Use **Stitch Creator™** feature and Sequence Creator to create your own stitches and sequences. The selected stitch is shown in actual size in the stitch field.

## Sewing Mode – Overview

Recommendations, Information and Active Features are shown under the expandable Information Area headings.



1. [Help Center](#)
2. [mySewnet™ cloud](#)
3. [WiFi Signal Strength](#)
4. [Sewing Recommendations](#)
5. [Information](#)
6. [Active Features](#)
7. [Stitch Repeat](#)
8. [Stitch Edit](#)

9. Settings
10. Stitch Creator™ feature
11. Sequence Creator
12. Balance Adjustments
13. Full Screen View
14. Tie-Off Options
15. Free-Motion Options
16. Tapering
17. mySewnet™ cloud folder
18. Load Stitch
19. Menu Panel
20. Quick Help
21. Main Menu

## Getting Started with Sewing

Touch Start Sewing to enter the Sewing Mode. A straight stitch is loaded by default. If you prefer, you can set a different stitch to be the default stitch. Touch Stitch Menu in the Menu Panel to load a new stitch. It is also possible to enter Main Menu to load a stitch from the Selection Menu tab.

### Load a Stitch From the Menu Panel

Touch Load Stitch and select the desired stitch. Available stitch categories are listed horizontally, swipe to see more categories. Select a category by touching it and then touch a subcategory to view the available stitches. Touch a stitch to load it to Sewing Mode. The select stitch window can be expanded if you touch and drag the triangle in the lower corner. The entire Menu Panel can be moved around on the screen, simply touch & hold on the colored panel top to move it where you want it to be placed.

Start Sewing

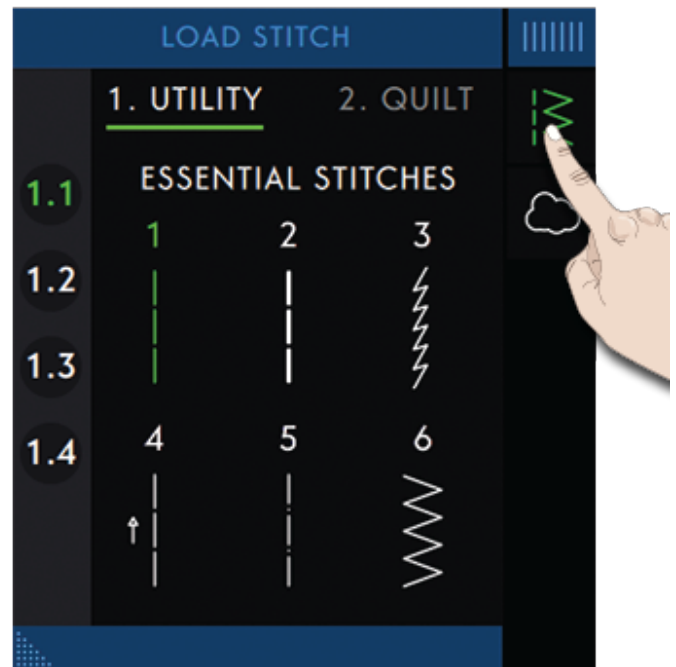

## Select a Stitch From the Selection Menu

Touch Main Menu to open the Selection Menu tab. Available stitch categories are listed horizontally, swipe to see more categories. Select a category by touching it and then touch a subcategory to view the available stitches. Touch a stitch to see a preview of the stitch with a stitch description. Use the arrows in the preview to step between the stitches in the selected subcategory. Touch LOAD to open selected stitch in Sewing Mode. Touch & hold on a stitch to load it directly to Sewing Mode without the preview.

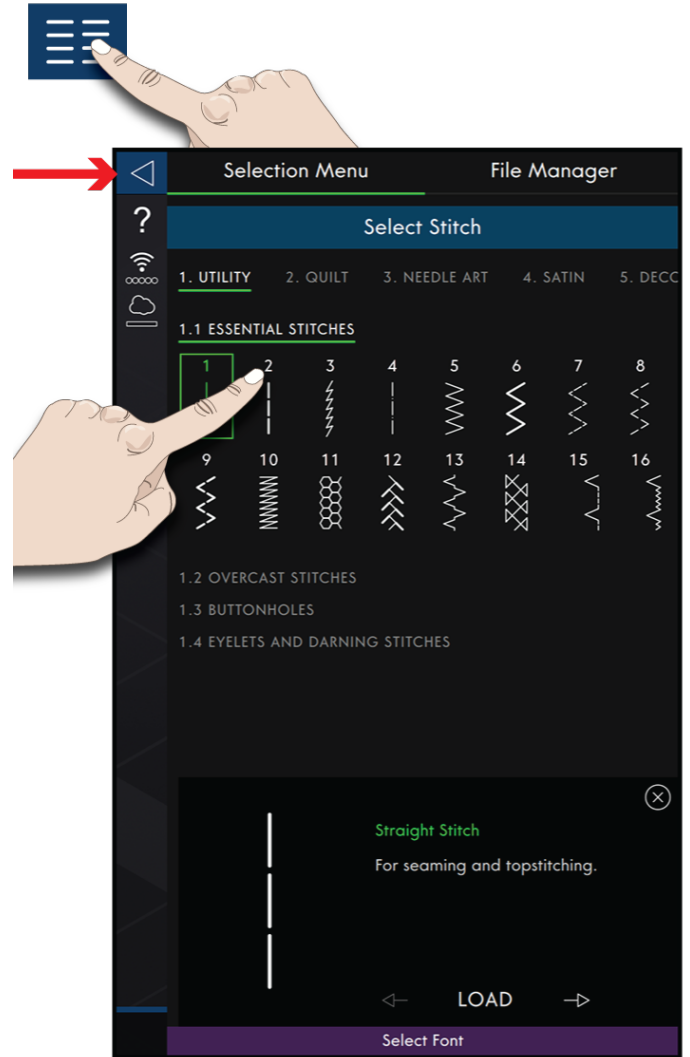

## Load a Stitch from File Manager

Touch Main Menu and select the File Manager tab to access stitches that you have saved in your *mySewnet*<sup>™</sup> cloud folder or on a USB device. Touch and hold on the stitch file to load it.

*Note: The mySewnet<sup>™</sup> cloud folder is also accessible in the Menu Panel.*

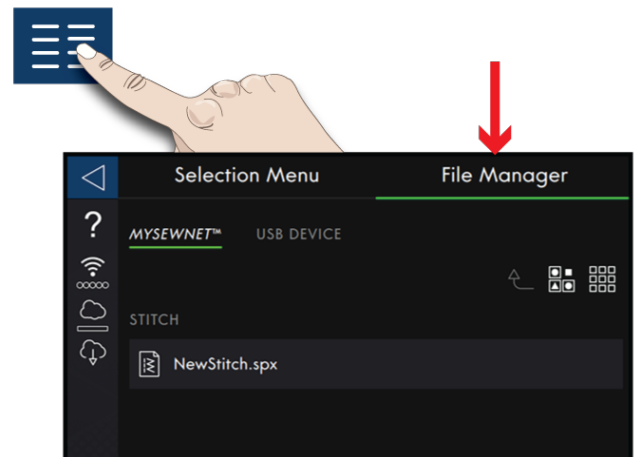

## Sewing Recommendations

Recommendations are shown in the Information Area. Your machine automatically gives you recommendations depending on the selected stitch and current setting.

The following recommendations can be shown:

Presser foot, IDT™ system and Stabilizer. The Straight Stitch Needle Plate recommendation will be shown when a Free-Motion Option is selected with a straight stitch. The Straight Stitch Bobbin Case will be shown if you move your straight stitch to the left.

We recommend that you use [The Stabilizer Guide](#) in the Help Center for detailed information about the different stabilizers.

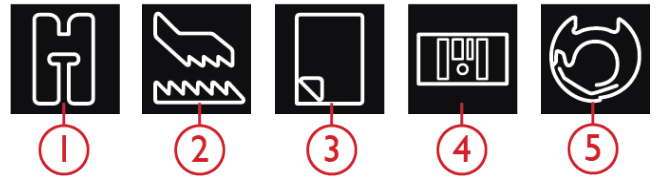

1. Presser Foot Recommendation
2. IDT™ Recommendation
3. Stabilizer Recommendation
4. Straight Stitch Needle Plate
5. Straight Stitch Bobbin Case

## Settings in Sewing Mode

There are two ways to change your settings.

1. Default Settings – Settings made in Default Settings will be saved, even when turning your machine off.
2. Temporary Settings – Settings made in Temporary Settings will be reset at the start of a new project in Help Center or start of a new sewing session. When turning your machine off, all changes made in Temporary Settings will be reset to default.

Changes made in Temporary Settings are shown under Active Features in the Information Area.

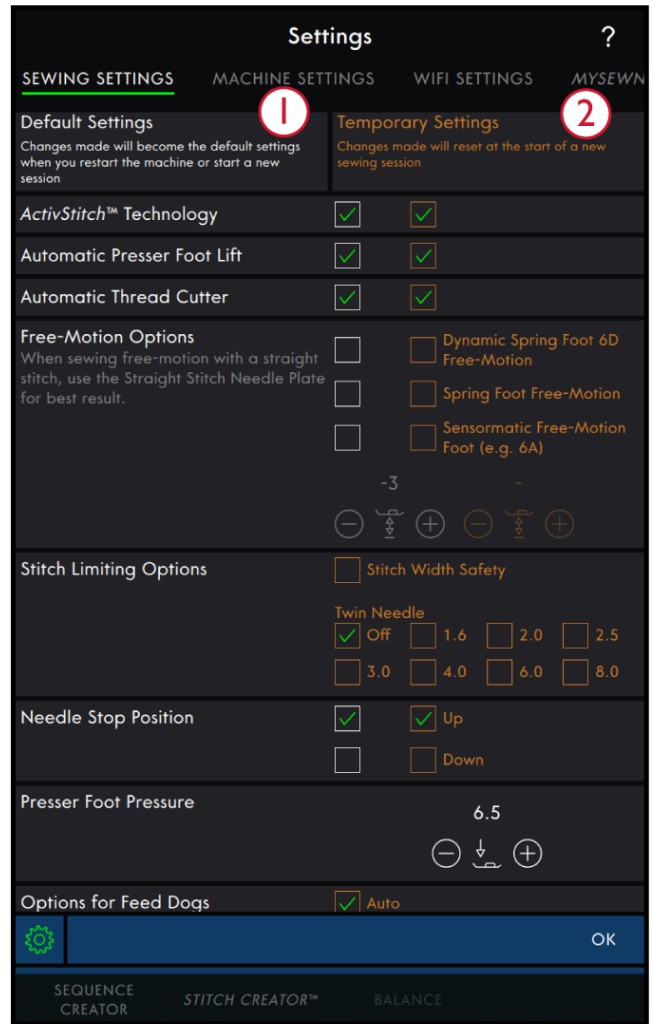

1. Default Settings in white colored check boxes
2. Temporary Settings in orange colored check boxes

### ActivStitch™ Technology

When the **ActivStitch™** technology feature is selected your machine will automatically choose the best way to control the upper thread, by thread metering or thread tension, based on your selected stitch and settings. Thread metering automatically and continuously measures the fabric thickness to meter the correct amount of thread for the selected stitch. When using thread tension, the tension discs will keep the correct amount of tension on the upper thread.

We recommend that you keep this setting selected except when using specialty techniques or accessories that do not support thread metering.

Deselect the **ActivStitch™** technology feature in the temporary settings to switch to thread tension. The control for adjusting thread metering/thread tension, will change depending on the active stitch and whether the **ActivStitch™** technology feature is selected or not in temporary settings.

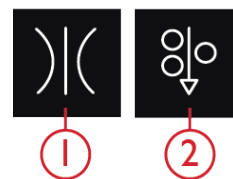

1. Thread Tension
2. Thread Metering

## Automatic Presser Foot Lift

When selected, the machine automatically raises the presser foot in the following situations:

- When stopping with the needle in down position the presser foot will automatically raise to pivot height.
- After a thread cut the presser foot will be raised to lift position.

When deselected, the presser foot will stay lowered, even if the machine stops with the needle in down position.

## Automatic Thread Cutter

When selected, the threads are cut automatically in the following situations:

- At cut commands in stitches and sequences.
- After sewing a single stitch e.g. a monogram or eyelets.

If deselected, no automatic thread cut will be performed.

*Note: Deselect when using optional accessories that are attached in the two holes in the needle plate just above the bobbin cover, to prevent damage to the automatic thread cutter knife located under the needle plate.*

## Free-Motion Options

All stitches on your machine can be sewn in free-motion mode to create fantastic effects. You can select between three different Free-Motion Options. For all free-motion sewing the Feed Dogs will lower automatically and the fabric must be moved manually.

Free-Motion Options are accessible both in Settings and if you touch Free-Motion icon in Sewing Mode. Your Temporary Settings are shown under Active features in the Information Area.

*Note: Make sure that the IDT™ system is disengaged.*



*Free-Motion Options*

## Stitch Limiting Options

Set the machine to stitch width safety or select the size of the twin needle to limit the stitch width and stitch positioning. This will minimize the risk of breaking a needle when sewing with accessories that do not allow the use of the entire stitch width.

### Stitch Width Safety

When selected, the machine will only allow a centered straight stitch to prevent damage to the needle, presser foot and needle plate. Select stitch width safety when using an accessory that only supports a centered needle position e.g. straight stitch presser foot. Stitch width safety will automatically be selected when the Straight Stitch Needle Plate is attached to the machine and cannot be deselected as long as the Straight Stitch Needle Plate is attached.

When the Straight Stitch Needle Plate is removed you will be given the option to keep stitch width safety selected or to deselect it. When stitch width safety is activated all twin needle sizes will be disabled as they cannot be used with stitch width safety.

*Note: The setting is reset at the start of a new project in Getting Started or a new sewing session. Always make sure to remove any accessory that requires this setting or select the setting again after starting a new project or session.*



Stitch Width Safety

### Twin Needle

When a twin needle size is selected, the stitch width and stitch position of all stitches are limited according to the selected twin needle size to prevent damage to the needle, presser foot and needle plate. In Sewing Mode the Active Features will show that a twin needle is selected. When a twin needle size is selected, the stitch width safety will be disabled as it cannot be used with a twin needle.

*Note: The setting is reset at the start of a new project in Getting Started or a new sewing session. Always make sure to remove any accessory that requires this setting or select the setting again after starting a new project.*



Twin Needle

## Needle Stop Position

When Up is selected your machine stops with the needle up. When Down is selected your machine stops with the needle down. This setting can also be made by touching the Needle Up/Down button on the front of the machine.



Needle Stop Position

## Presser Foot Pressure

In most cases, you do not need to adjust the presser foot pressure. Specialty techniques may require an adjustment. The higher the number the more pressure on the fabric.



Presser Foot Pressure

## Options for Feed Dogs

When Auto is selected (recommended) your machine automatically raises or lowers the Feed Dogs, depending on the stitch and other selected settings. For example, the Feed Dogs are lowered when sewing on buttons or when free-motion sewing.

Select Up and the Feed Dogs will be raised for all sewing. Select Down and the Feed Dogs will be lowered for all sewing.

*Note: The machine will always lower the Feed Dogs automatically when raising the presser foot to extra lift position.*

*Note: The Feed Dogs options will automatically be reset to auto at the start of a new project from the Help Center.*

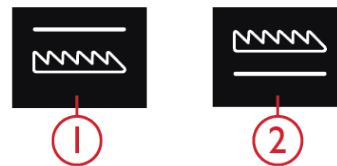

1. Feed Dogs Lowered

2. Feed Dogs Up

## Tie-Off Options

These options let you program a Tie-Off at the beginning and at the end of a stitch. It is also possible to program thread cut at the end of a stitch.

When touching the Tie-Off icon, three options open to let you select different functions; Tie-Off Beginning, Tie-Off End and Thread Cut.

Touch Tie-Off to close Tie-Off Options window. Your settings are shown under Active Features in the Information Area.

*Note: For immediate Tie-Off, use the Tie-Off button, found on the front of the machine.*



Tie-Off Options

## Stitch Edit

Touch Stitch Edit to open the control window for adjusting selected stitch.

Touch Stitch Edit to close the control window.

*Note: The Default Setting is always shown in white numbers.*

The performance icon™ allows you to access the functions you use the most by arranging them as you desire on the sewing area. Touch the Detach icon to show which controls that can be moved around. Touch & hold the Move icon in the center until the control pop's up. Drag and drop it to desired location. Your machine will remember your changes when turning your machine off. Touch the x to close the control. To reset the Toolbar to default, use Smart Toolbox and select Reset Toolbar.



## Stitch Width

Increase or decrease the stitch width using - and + in the control. The number above the control shows stitch width in mm.

Changed stitch position may limit the stitch width adjustments.



## Stitch Positioning

On certain stitches with a width less than 9 mm it is possible to change the stitch position. Use - to move the stitch to the left and + to move the stitch to the right. The number above the control shows the needle start position in mm in relation to center needle position. The machine has a maximum of 37 needle positions (for a straight stitch).

The stitch position can only be changed to the limit of the maximum stitch width. Changing the stitch positioning will also limit the stitch width adjustments.

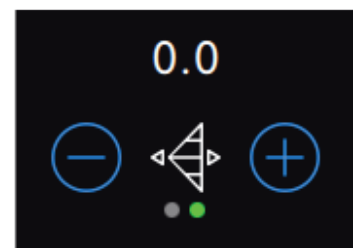

## Stitch Length

Increase or decrease the stitch length using - and + in the control. The number above the control shows the set stitch length in mm. If lengthening a zigzag stitch or a decorative stitch, the entire stitch will be stretched out. If lengthening a stitch where the density can be adjusted, the entire stitch will be longer but the density of the satin stitches will remain the same.



## Stitch Density

The stitch density control adjusts the density (the distance between the individual satin stitches that make the entire stitch). The density does not affect the actual length of the entire stitch.

Touch - to increase the density. Touch + to decrease the density. The number above the control shows the distance between satin stitches in mm.

*Tip: Decrease the density to get different visual effects e.g. when using speciality threads.*

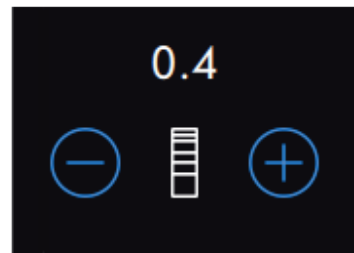

## Mirroring

To mirror a stitch or stitch sequence sideways, touch Mirror Side to Side. To mirror a stitch or stitch sequence lengthwise, touch Mirror End to End.

*Tip: Use the [Smart Toolbox](#) to open a shortcut for mirroring.*

*Note: Some stitches e.g. buttonholes cannot be mirrored.*

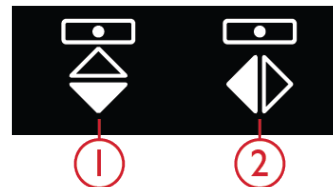

1. Mirror Side to Side
2. Mirror End to End

## Buttonhole Slit Length

Set the buttonhole slit length by using - to decrease and + to increase when sewing a buttonhole with the Sensomatic Buttonhole Foot.

You can also sew a manual buttonhole, read about how to sew a manual buttonhole and how to repeat a manual buttonhole in the [Sewing Techniques](#) chapter.

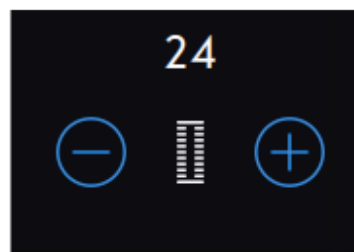

## Button Stitch Repetition

When sewing a button, you can set the number of stitch repeats. Touch the - or + in the control to decrease or increase the number of stitch repeats.

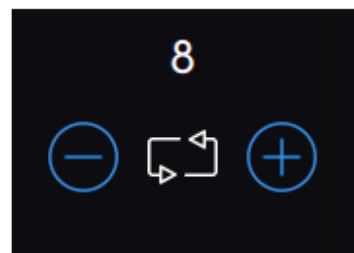

## ActivStitch™ Technology

The **ActivStitch™** technology feature has two ways to control the needle thread: thread metering and thread tension. To get the best sewing result it will automatically use thread metering when possible. Thread metering automatically and continuously measures the fabric thickness to meter the correct amount of thread for the selected stitch.

When thread tension is used, the tension discs will keep the correct amount of tension on the upper thread. Some special techniques may require the use of thread tension. Deselect the **ActivStitch™** technology feature in Temporary Settings to ensure that thread tension is engaged. When the **ActivStitch™** technology feature is selected the control visible in Sewing Mode will change between thread metering and thread tension depending on the current settings and the loaded stitch.

Use the thread metering/thread tension control to adjust the balance between needle thread and bobbin thread, e.g. decrease when using metallic thread and increase when using heavy weight thread. Make a few tests with different settings on a scrap piece of the fabric you are going to use and check the balance between the upper thread and the bobbin thread.

*Note: When changing the value of the thread metering/thread tension setting, the changes only affect the selected stitch. Your changed settings will be reset to default when selecting another stitch.*

*Tip: Increase the thread metering/thread tension setting for best results when sewing on denim fabric with thick threads.*

### Adjust Thread Tension/Thread Metering

For the best stitch appearance and durability make sure the threads meet evenly between the two fabric layers.

If the bobbin thread is visible on the top side of the fabric, the thread tension/thread metering is too tight. Reduce the thread tension/thread metering.

If the upper thread is visible on the underside of the fabric, the thread tension/thread metering is too loose. Increase the thread tension/thread metering.

For decorative stitches and buttonholes the upper thread should be visible on the underside of the fabric.

Make a few tests on a scrap piece of the fabric you are going to use and check the tension.

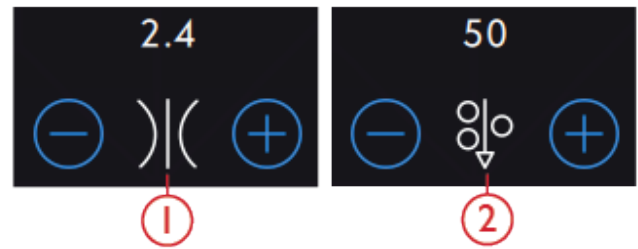

1. Thread tension
2. Thread metering

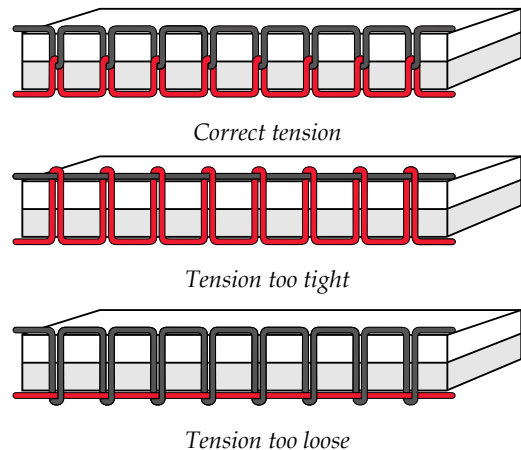

## Free-Motion Options

All stitches on your machine can be sewn in free-motion to create fantastic effects. Touch Free-Motion to open a window where you can select between three different Free-Motion Options. For all free-motion sewing the Feed Dogs will lower automatically and the fabric must be moved manually.

Touch Free-Motion to close the Free-Motion Options window. Your settings are shown under Active features in the Information Area.

*Note: Make sure that the IDT™ system is disengaged.*

### Dynamic Spring Foot 6D Free-Motion

Activate to set the machine in Dynamic Spring Foot Free-Motion mode for the Dynamic Spring Foot 6D Free-Motion. The Dynamic Spring Foot measures the fabric thickness and will raise and lower with each stitch to hold the fabric on the needle plate while the stitch is being formed.

*Note: The Dynamic Spring Foot 6D is recommended for use with straight stitch. Activate Stitch Width Safety in Settings.*

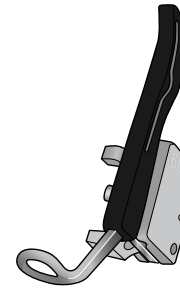

*Dynamic Spring Foot 6D Free-Motion*

### Spring Foot Free-Motion

Activate to set the machine in Spring Foot Free-Motion mode for optional spring feet. A spring foot will raise and lower with each stitch to hold the fabric on the needle plate while the stitch is being formed.

*Note: Optional spring feet can be purchased at your local authorized PFAFF® dealer.*



*Do not use a spring foot if Sensormatic Free-Motion is activated, since the needle might damage the presser foot.*

## Sensormatic Free-Motion

Activate to set the machine in Sensormatic free-motion mode for presser foot 6A or some other sensormatic foot, e.g yarn couching etc.

When sewing free-motion at low speed the presser foot will raise and lower with each stitch to hold the fabric on the needle plate while the stitch is being formed. At higher speed, the presser foot floats over the fabric while sewing.

Skipped stitches can occur if your fabric moves up and down with the needle as you are stitching. Lowering the presser foot height will reduce the space between the presser foot and the fabric and eliminate the skipped stitches.

To adjust the presser foot height in Sensormatic free-motion mode, open the Free-Motion options window and change presser foot height by touching + or – to increase or decrease presser foot height.

*Note: Be careful not to reduce the presser foot height too much. The fabric must still move freely under the presser foot.*

## Tie-Off Options

These options allow you program Tie-Off at the beginning and at the end of a stitch. It is also possible to program Thread Cut at the end of a stitch.

When touching the Tie-Off icon, three options open to let you select different functions; Tie-Off Beginning, Tie-Off End and Thread Cut.

Touch Tie-Off to close Tie-Off options window. Your settings are shown under Active features in the information area.

*Note: For immediate Tie-Off, use the Tie-Off button, found on the front of the machine.*

### Sewing with Tie-Off Options selected

- The Tie-Off Beginning will be performed as soon as you start to sew.
- Press the Reverse button to perform Tie-Off End. The action indicator lamp will be lit to indicate that the machine will finish the stitch and do the Tie-Off.
- When a Thread Cut is programmed, the machine will automatically cut the threads after performing a stitch. The needle and presser foot will raise.

*Note: Stop sewing and press the Reverse button twice to activate reverse sewing. The reverse indicator lamp will be lit. No Tie-Off will be performed.*

*Press the Reverse button when sewing in reverse to activate Tie-Off End. The action indicator lamp will be lit.*

*To go back to sewing forward, stop sewing in reverse and press the Reverse button. No Tie-Off will be performed.*

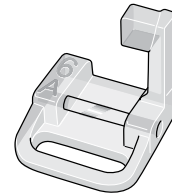

Sensormatic Free-Motion Foot 6A



Tie-Off button



Reverse button

## Stitch Repeat

Stitch Repeat makes it possible for you to program an exact stitch length, it also lets you decide how many repetitions of a stitch you want to sew.

Read about Stitch Repeat, Patchwork Program and Single Stitch in the [Stitch Repeat chapter](#).



## Save Stitch

To save your file, touch the Save button, located below the Multi-Touch Screen and a pop-up will appear on the screen. In the Save pop-up you can choose to save your file to the *mySewnet*™ Cloud folder or to a USB device. Previously saved stitches, sequences and/or fonts are shown. Name your file using the keyboard and touch OK to confirm.

If you want to save to a folder, touch & hold on the folder to open it, then name your file using the keyboard and touch OK in the pop-up to confirm. To create a new folder, simply touch Create New Folder, name the folder with the keyboard and touch OK. Then touch & hold on the folder to open it and save into the new folder.

Touch the List and Thumbnail View icon to toggle between showing the files in a list or as thumbnail icons. In List View each file is shown with the file name and file type. In Thumbnail View each file is shown with the file name and a thumbnail image of the file.

To cancel the save process, close the pop-up window by touching Close. The Save pop-up will close and you will return to Sewing Mode.

Read about organizing your saved stitches in [File Manager](#).



Save button

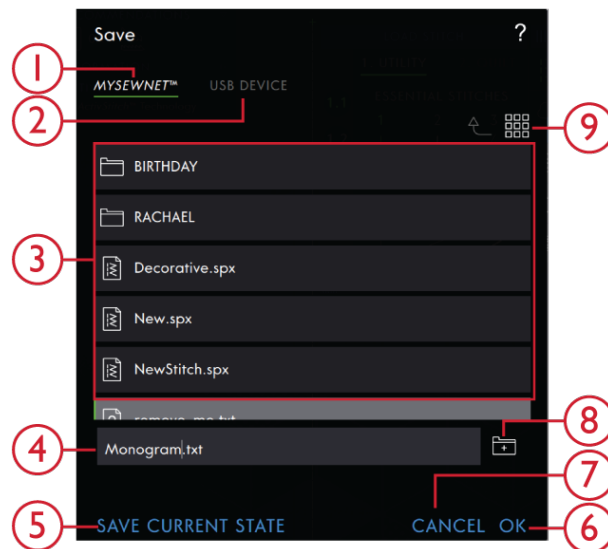

- |   |                            |
|---|----------------------------|
| 1. Save to <i>mySewnet</i> ™ cloud Folder | 6. OK                      |
| 2. Save to USB Device                     | 7. Close                   |
| 3. Selection Area                         | 8. Create New Folder       |
| 4. File Name                              | 9. List and Thumbnail View |
| 5. Save Current State                     |                            |

## Balance

When sewing on special fabrics or doing a special technique, the balance may need to be adjusted.

Start by sewing the stitch on a piece of scrap fabric. Touch Balance in the Base Bar to open the Balance Adjustment window. Change the preview on the screen to match your sewn sample by using the + and - in the controls. When you sew again, the balance will be corrected.



# Sewing Programs

These techniques may require some special presser feet and accessories.

## Tapering Stitches

The Tapering commands will be visible when a stitch that can be tapered is selected. Touch the Tapering menu to open a view of angles for beginning and end tapers. Select an angle by touching it in the selection area. The machine will sew the beginning tapered point and then continue with the selected stitch. When the desired length has been sewn, touch the Reverse button. The stitch will taper to the end. Select taper Off to remove any tapering at the beginning or end of the stitch. If you select taper Off on both the beginning and end, the stitch will be a regular stitch without tapering.

*Note: The Tapering commands will not be visible if you select e.g. a buttonhole.*

## Taper Satin Stitch Exercise

The Taper Stitch automatically tapers the satin stitch for corners and points and can be used for satin stitch lettering. Try the satin stitch exercise and stitch a corner of the tapered satin stitch on a piece of stabilized fabric.

1. Select stitch 4.3.6 in menu 4 - satin stitches.
2. Open Tapering and select 45 degrees for both beginning and end.
3. Activate Needle Stop Up/Down on your machine and start to sew. The machine will sew the tapered point and then continue with a satin stitch at the selected width.
4. When the satin stitch is as long as desired, touch the Reverse button. This will start the end tapering.
5. Turn your fabric to continue with the next tapered satin stitch.



## Stitch Repeat

Stitch Repeat makes it possible for you to program an exact seam length, it also lets you decide how many repetitions of a stitch you want to sew.



## Patchwork Program

The Patchwork Program makes it possible for you to program an exact stitch length that can be sewn repeatedly. This is very useful when quilting.

To program a stitch length, touch Stitch Repeat on the Toolbar and select Patchwork Program. Sew your desired stitch length and press the Reverse button while sewing. The reverse indicator on the machine will be lit until the last repetition of the stitch is finished. This will set the length of the stitch.

Once you have set the length of a stitch, the Patchwork Program is inactive. The Single Stitch program is now activated instead. The programmed length of your patchwork seam is shown in millimeters above the +/- control. Adjust the length using the +/- controls.

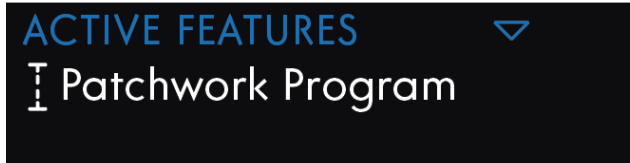

## Single Stitch Program

The Single Stitch Program lets you decide how many repetitions of the stitch you want to sew. Touch Stitch Repeat and select Single Stitch Program. Set the number of repetitions using the +/- . The number of repetitions are shown above the +/- and the estimated length of the repetitions is shown in the working area. The machine will stop automatically when the repetitions are sewn.

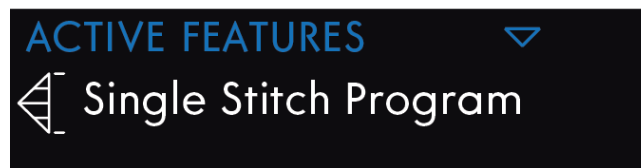

## Combining Programs

Combining Tapering and Patchwork Programs makes it possible to repeat a tapered seam with the same length.

Activate tapering as described in [Tapering](#). Sew your desired length. When the Reverse button is pressed the reverse indicator will increase the light until the end taper and last repetition of the stitch is finished.

The seam is now programmed and the Single Stitch Program is activated. When you start sewing again the seam will automatically be repeated with the same length.

The number of repetitions and estimated length in millimeters is shown above the +/- . Adjust the length using the +/- .

*Note: The Tapering is included in the repetitions shown on the screen.*

# Sewing Techniques

These techniques may require some special presser feet and accessories.

## Buttonholes

### Sensormatic Buttonhole

When you sew a buttonhole with the Sensormatic Buttonhole Foot, adjust the slit length so that it is slightly larger than the size of the button. You can measure your button using the button ruler on the lid.

Set the slit length and make sure that the red arrow lines up with the marking on the foot. Start sewing by pressing the foot control or Start/Stop button. The buttonhole will be completed automatically and the threads are cut. You can repeat the buttonhole as many times as you wish.

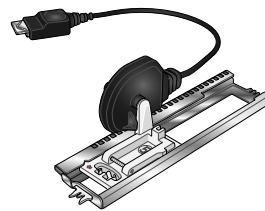

Sensormatic Buttonhole Foot

### Manual Buttonhole

To sew a manual buttonhole, use presser foot 5M.

Sew the first column as long as you want the buttonhole.

Touch the Reverse button.

The machine sews the bartack and the second column.

When the columns are aligned, press the Reverse button to sew the second bartack.

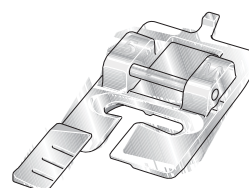

Presser Foot 5M

### Repeat a Manual Buttonhole

When you have adjusted your buttonhole, use the Repeat Buttonhole icon to sew identical copies. As long as that icon is selected, the machine will repeat the buttonhole over and over again. The Repeat Buttonhole icon is only visible when sewing a buttonhole manually. To cancel the function just deselect the icon.

### Corded Buttonhole

Corded buttonholes that are sewn with gimp threads are more stable, durable and have a professional appearance. Use pearl cotton or regular gimp thread.

1. Place the center of a length of gimp thread over the metal bar extending from the center back of the Manual Buttonhole Foot 5M. Pass the thread ends under the foot to the front of the foot.

2. Snap on the Manual Buttonhole Foot 5M.

3. After completing the buttonhole, pull the ends of the gimp thread until the loop of thread is hidden below the buttonhole bartack.

4. Thread the gimp threads into a needle and pull them to the wrong side of the garment. Tie the gimp threads and cut off the excess thread.



1. Repeat Buttonhole
2. Buttonhole Start Position
3. Reverse

## Sew On a Button

To sew on a button, remove the presser foot and select button sewing. The Feed Dogs will automatically be lowered.

Place the button under the presser foot holder. Use the Mirroring icon to make sure the holes in the button are aligned with the swing of the needle and the width is appropriate for the actual button. If needed change the width between holes with the Width icons.

If needed, increase or decrease the number of stitches that will fasten the button on the fabric, using the Stitch Repetition icon. Start to sew. The machine will sew the program for you.

## Four Direction Sewing

Use the Four Direction stitches for sewing on patches without having to turn your fabric or for decorative stitch designs. When selecting a stitch in category 9 and subcategory 2, the Four Direction stitch is loaded to sewing mode.

The starting point is marked with an x in the stitch field. To change direction touch one of the four stitches. When the desired length is sewn in one direction, select the new direction by touching one of the four directions.

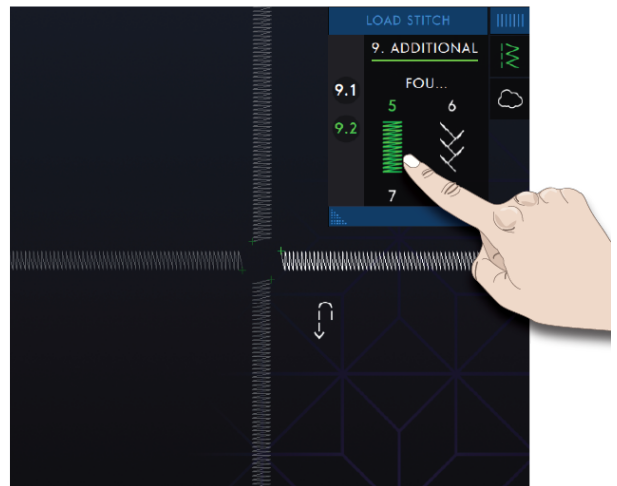

## Special Stitch Techniques

Special Stitch Technique stitches in your performance icon™ machine includes stitches such as Ribbon, Stacking, Floating, Radiant and Lace Edge stitches.

### Ribbon Stitches

Add dimensional elements to your decorative stitching with the beautiful Single, Double and Triple Ribbon stitches in your machine. Narrow ribbons are woven into these special stitches as you sew. 2-5 mm (approx. 1/8" - 1/4") ribbons are recommended for single and double ribbon stitches. For triple 2-10 mm (approx. 1/8" - 3/8") For best results, use stabilizer, appropriate for your fabric type and weight, under your fabric to support your stitching.

We recommend you to use [Help Center](#) and locate the Ribbon Stitches Projects for instructions on how to sew and automatically get the correct settings.

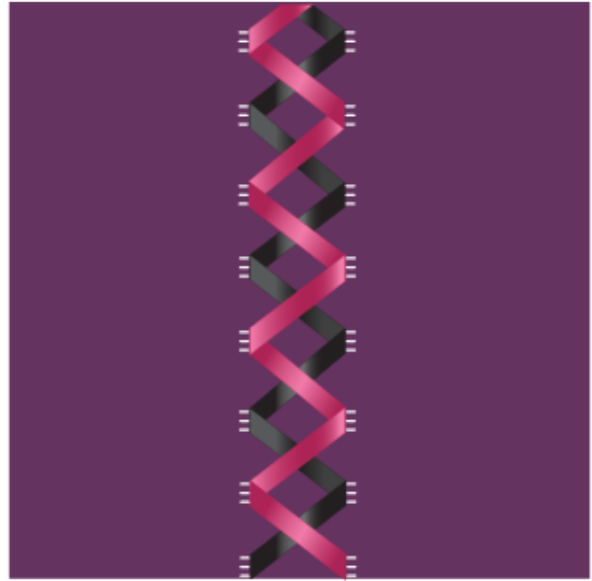

### Stacking Stitches

Sew beautiful decorations in two colors using the Stacking stitches. The Stacking stitches consist of pairs of matching stitches that are designed to be sewn on top of each other.

Sew the first stitch and then sew the second, overlapping the first. Be sure to use the same starting point for each.

Touch Quick Help and one of the Stacking stitches to preview what the stitches look like when combined/stacked.

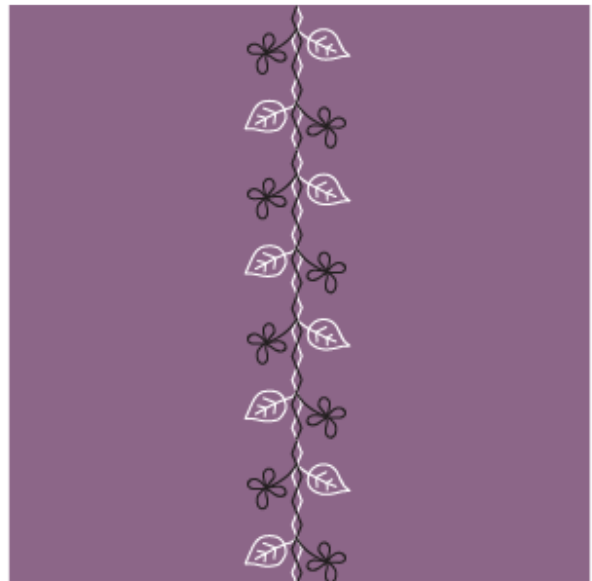

## Floating Stitches

Floating stitches create a special effect where the connecting stitches are invisible. There are two different ways to use this technique; the first technique is to sew with the Bi-Level Guide Foot, a piece of stabilizer and one piece of folded fabric. The second technique is to sew two pieces of fabric together.

Sewn with the Bi-Level Guide Foot:

1. Fold the fabric, right sides together, and place the stabilizer underneath, making sure it extends outside the folded edge.
2. Attach the Bi-Level Guide Foot and engage the IDT™. Let the folded edge follow the guide of the foot.
3. Once finished, pull the fabric over.

Sewn with 1A foot:

1. Place two pieces of fabric, right sides together, and place a stabilizer underneath.
2. Attach the 1A foot and engage the IDT™. Start to sew using the desired seam allowance.
3. Once finished, pull the fabric flat.

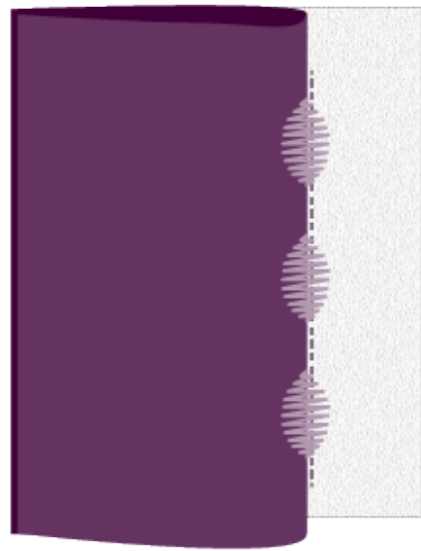
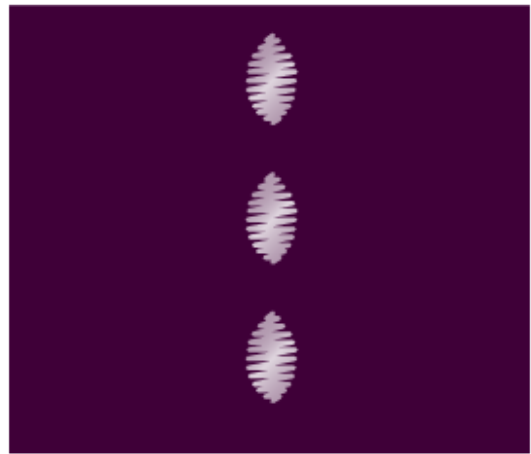

## Radiant Stitches

Radiant stitches are an Exclusive PFAFF® sewing technique. These stitches have a built in stop allowing you to sew a line of stitches in any shape. Make beautiful necklines or pocketlines on garments.

1. Draw a line, using a marking pen, on your fabric where you want the stitch to be placed. Attach the 2A foot.
2. Place the fabric and stabilizer underneath the presser foot.
3. Activate Needle Down function.
4. Line up the center marking of the presser foot with the drawn line.
5. Touch Start/Stop and sew until the machine stops. The next time you touch Start/Stop the machine will sew backwards.
6. Turn the fabric so that the two side markings on the foot matches the drawn line. Touch Start/Stop and sew until the machine stops.
7. Repeat step 4–6 until you have reached the desired length.

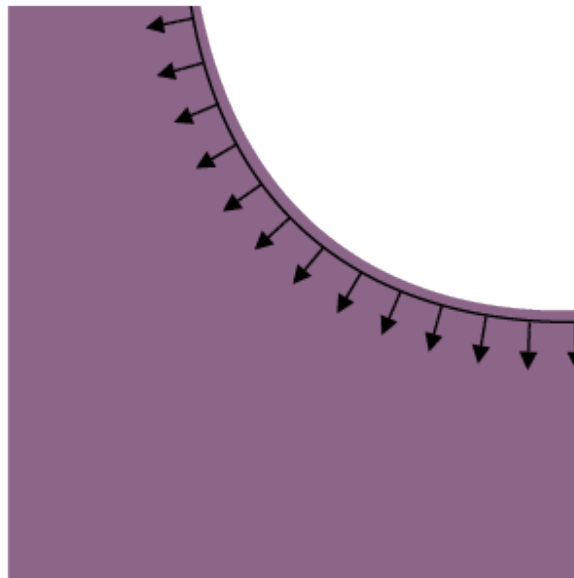

## Lace Edge Stitches

Sew beautiful Lace Edge stitches on your projects using the Bi-Level Guide Foot and water soluble stabilizer.

1. Attach the Bi-Level Guide Foot and engage the IDT™.
2. Fold the fabric and place water soluble stabilizer underneath, making sure that the stabilizer extends outside the folded fabric edge.
3. Let the folded fabric edge follow the guide of the foot. Sew as long as you want the lace to be and remove it from the sewing machine.
4. Dissolve the water soluble stabilizer in lukewarm water.

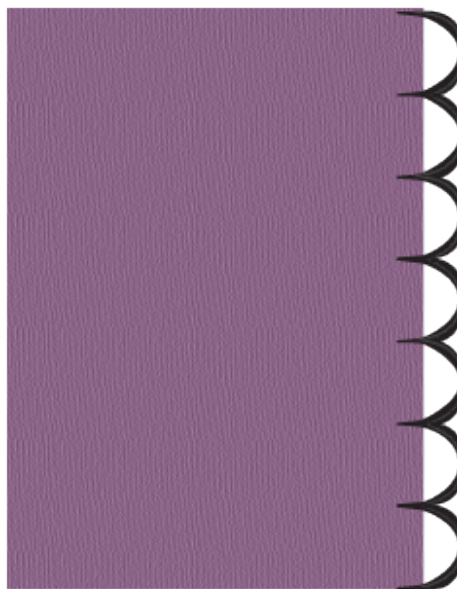

## Optional Feet Stitches

This subcategory includes special stitches for sewing techniques such as candlewicking, beading stitches and edge stitches. These techniques require special presser feet and accessories.

*Note: Touch Quick Help and then touch the selected stitch in the stitch selection area to find out which special presser foot is required for that stitch.*



Optional Feet Icon

# Pop-up Messages in Sewing

## Bobbin Thread Low

When the bobbin thread is running low, a pop-up message appears giving you notice that you will soon need to replace the bobbin. If you want to continue sewing without replacing the bobbin, touch the foot control and do not close the pop-up.

When the bobbin is replaced with a full one, touch OK in the pop-up.



## Check Upper Thread

The machine stops automatically if the upper thread runs out or breaks. Re-thread the upper thread, close the pop-up message and start sewing.

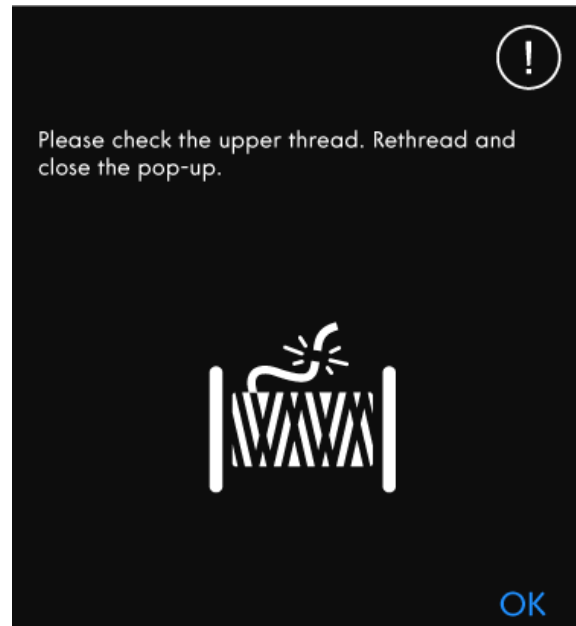

## Remove Sensormatic Buttonhole Foot

The Sensormatic Buttonhole Foot needs to be removed before doing any of the following:

- Sewing a stitch that is not a buttonhole.
- Sewing a buttonhole that can not be sewn with the Sensormatic Buttonhole Foot.
- Sewing an adjusted buttonhole saved without the Sensormatic Buttonhole Foot in the *mySewnet*<sup>™</sup> cloud folder.

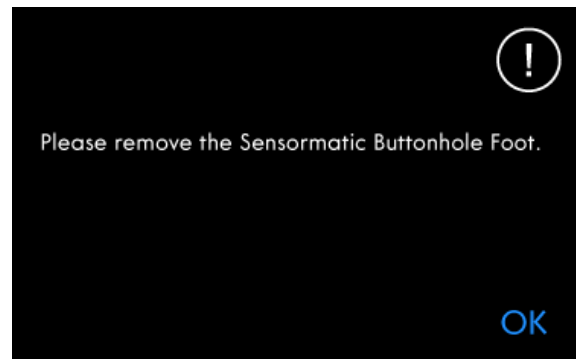

### Cannot Use the Automatic Needle Threader

If using a twin needle, touch OK and thread it manually.  
If using a regular needle, touch OK and deselect twin needle in the settings. Press the Automatic Needle Threader button again.

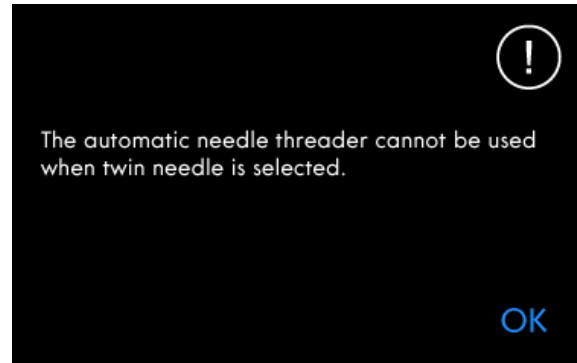

### Twin Needle

The following pop-up message appears when you choose a stitch not suitable for twin needle.

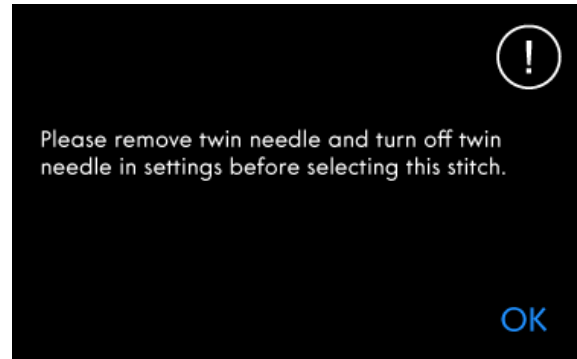

### Stitch Width Safety

When Stitch Width Safety is activated, the following pop-up message appears when you choose a stitch not suitable for stitch width safety.

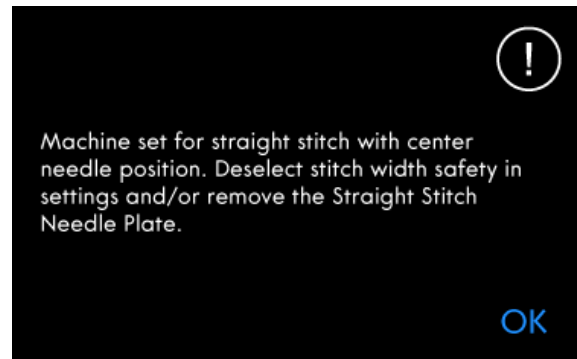

### Attention!

If the machine stops and this pop-up appears on the screen you need to stop sewing. Wait a moment and touch OK when it is enabled. Check the needle size and condition. Check for correct threading.

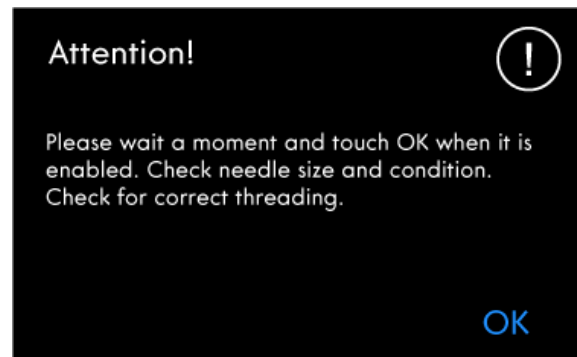

## 6 Sequence Creator

### Sequence Creator — Introduction

In Sequence Creator, you can create and adjust a sequence of stitches. Combine various 9mm stitches, side-motion stitches and stitch fonts from the machine, the *mySewnet*<sup>™</sup> cloud or from a USB device. Stitches made in **Stitch Creator**<sup>™</sup> feature can also be inserted in a sequence. You can create sequences up to approximately 500mm (20") long. You can see how long your actual sequence is in the information area.

# Sequence Creator – Overview



1. Sign in to mySewnet™ cloud
2. WiFi signal strength
3. Length of Sequence
4. Step Between Stitches
5. Stitch Settings Window
6. Stitch Width

7. Stitch Length
8. Stitch Settings
9. Keyboard
10. Cancel
11. OK
12. Full Screen View
13. True Size
14. Duplicate
15. Delete
16. Mirror End to End
17. Mirror Side to Side
18. Directional Stitches
19. Sequence Commands
20. Load from *mySewnet*<sup>TM</sup> cloud Folder
21. Load Font
22. Load Stitch
23. Menu Panel

# Getting Started with Sequence Creator

To start creating a sequence, select a desired stitch in the Menu Panel and add it to the sequence. To create a sequence from letters, select a desired font in the Menu Panel and load it to the sequence. The active position is marked by a cursor and the selected stitch or letter will be marked in green. Only the selected stitch/stitches can be adjusted. Inserted stitches will be placed at the cursor position. Move the cursor through the sequence using the arrows. The number of selected stitch and total number of stitches in the sequence are shown between the arrows. When sewing a sequence it is possible to start sewing anywhere in the sequence. Use the arrows to step through the sequence.

## SEQUENCE CREATOR

### Load a Stitch

Move the cursor where you want to add a stitch. Touch Load Stitch and select the desired stitch. Available stitch categories are listed horizontally, swipe to see more categories. Select a category by touching it and then touch a subcategory to view the available stitches. Touch a stitch to load it to Sewing Mode. The select stitch window can be expanded if you touch and drag the triangle in the lower corner. The entire Menu Panel can be moved around on the screen, simply touch & hold on the colored panel top to move it where you want it to be placed. It will be placed at the cursor position.

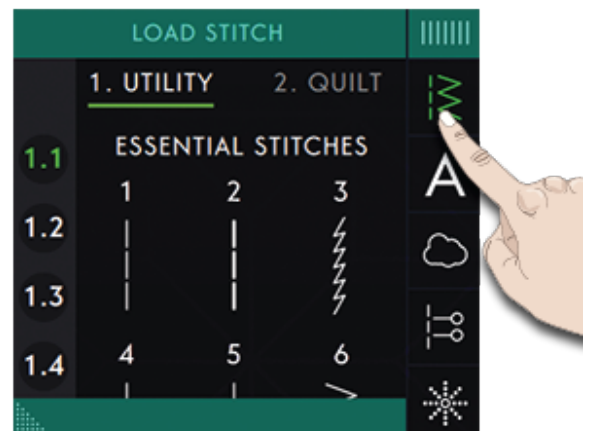

### Load a Font

Move the cursor where you want to add a letter and touch Load Font to select a desired font. Available fonts are listed vertically, swipe to see more. Touch a font to open a keyboard and touch the letters you want to add.

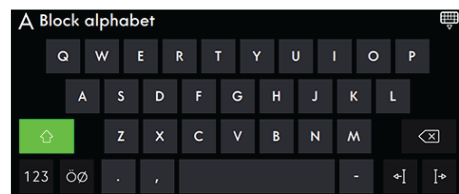
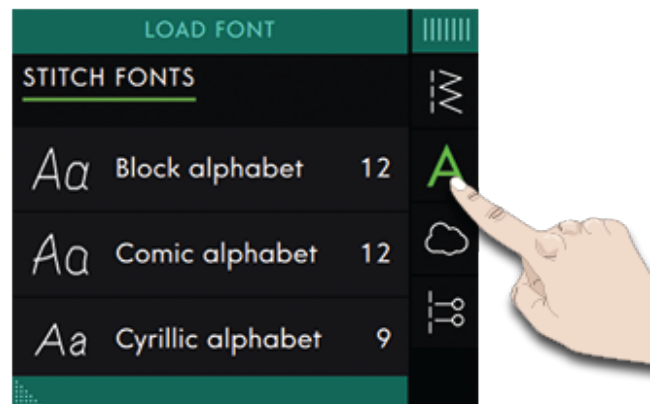

## Adjust text and stitches

You can mirror, adjust length and width or change the density or position of the selected stitch. The adjustments work just like in Sewing Mode.

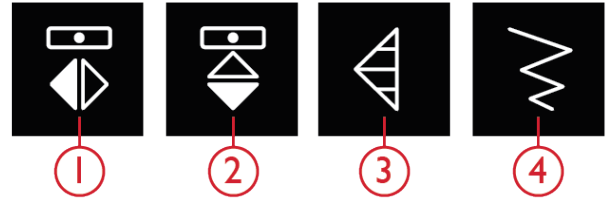

1. Mirror Side to Side
2. Mirror End to End

3. Stitch Length
4. Stitch Width

## Delete a Stitch or Letter

If you want to delete a stitch or letter, touch the stitch or move the cursor to the stitch or letter you want to delete and touch Delete. Touch & hold to delete the whole sequence.



Delete

## Duplicate a Stitch or Letter

To duplicate a stitch, move the cursor to the stitch you want to duplicate. Touch the Duplicate icon to copy the selected stitch.

*Note: Make your adjustments on the stitch before duplicating and the copied stitch includes the adjustments.*

Touch & hold to get a pop-up where you can enter the exact number of copies you want to insert.



Duplicate

## Replace a Stitch or Letter

To replace a stitch; simply select it, touch Delete and insert the new stitch.

It will be placed at the cursor position.

## Directional Stitches

Add Directional Stitches between stitches in a sequence. These stitches makes it possible to move stitches in various directions and you can create new shapes and wider large-area borders.

Directional Stitches are straight stitches with a length of approximately 1mm and can be used in 16 different directions.

Touch Directional Stitches in the Menu Panel to access different angles.

Touch the Directional Field to select which angle you want to insert a stitch.

When the intended angle is selected, touch the insert icon and one stitch will be inserted in the sequence at the cursor position.

The Directional Stitch can be deleted, duplicated or mirrored without closing the directional stitches pop-up.

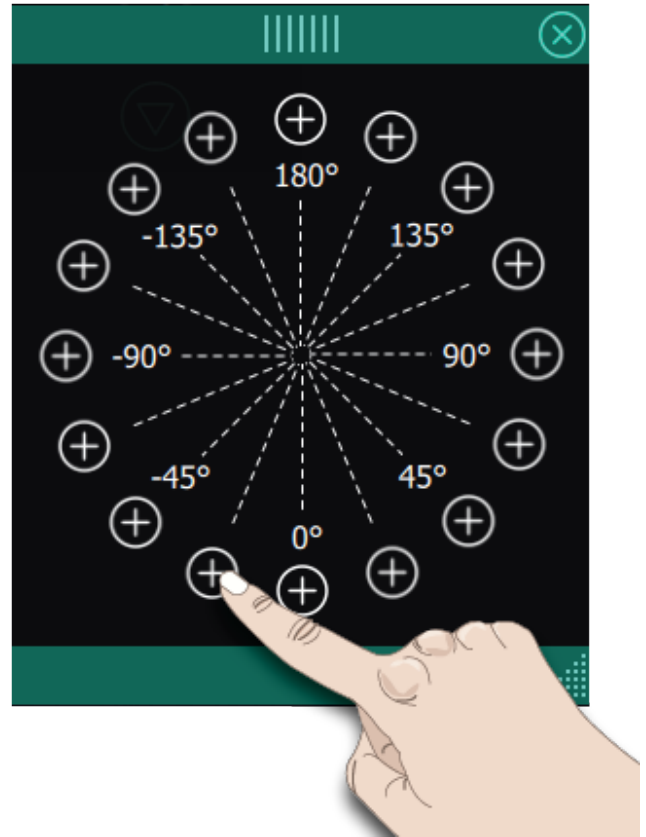

*Directional Stitches*

## Sequence Commands

You can insert Tie-Off, Stop and Thread Cut commands into the sequence. These commands will be included in the sequence and will always be performed when sewing it.

Use the Tie-Off command if you want a secure Tie-Off. You can insert the Tie-Off commands anywhere in the sequence.

Insert a Stop command if you want the machine to stop. This is useful for example at the end of the sequence if you want to sew it only once or to create a sequence in several rows.

Insert a Thread Cut command if you want the machine to Tie-Off and Cut the threads and raise the presser foot.

Move the cursor to the position where you want to add a command. Select it and an icon will be added into the sequence. This confirms that the command is inserted and it also shows where the command will be performed in the sequence.

*Note: The commands will appear on the screen in the order you program them.*

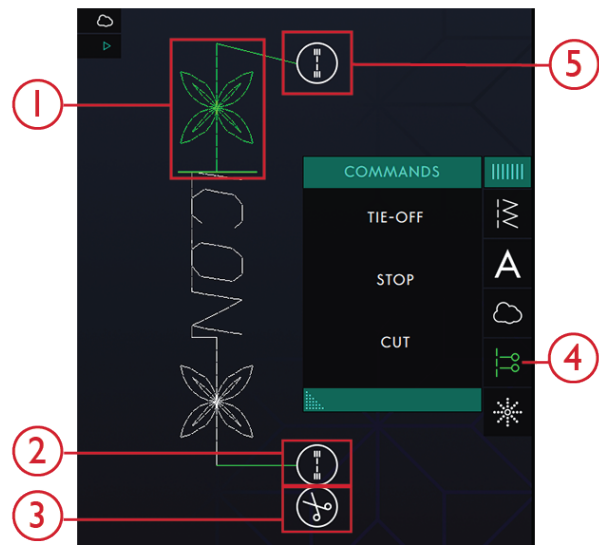

1. Editable Stitch in Green
2. Tie-Off End
3. Cut Command
4. Sequence Commands
5. Tie-Off Beginning

## True Size

Touch True Size if you want the sequence to return to its original size.



## Saving a Sequence

To save your file, touch the Save button and a pop-up will appear on the screen. In the save pop-up you can choose to save the file to the *mySewnet*<sup>TM</sup> cloud folder or to a USB device. Previously saved stitches, sequences and/or fonts are shown. Name your file using the keyboard and touch the OK button.

If you want to save to a folder, simply touch & hold on the folder to open it, then name your file using the keyboard and touch OK in the pop-up to save. To create a new folder, simply touch the create new folder button, name the folder using the keyboard and touch OK. Then touch & hold on the folder to open it and save into the new folder.

Touch List and Thumbnail View to toggle between showing the files in a list or as thumbnail icons. In List View each file is shown with the file name and file type. In Thumbnail View each file is shown with file name and a thumbnail image of the file.

To cancel the save process, close the pop-up window by touching Close. The save pop-up will close and you will return to Sequence Creator.

Learn how to organize your saved files in [File Manager](#).



1. Save button

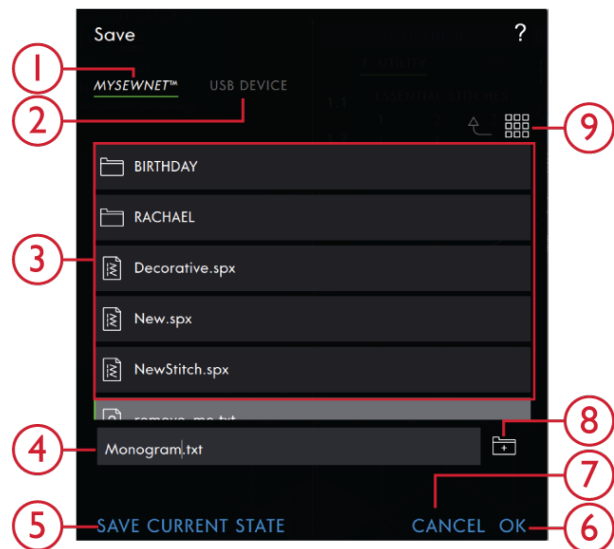

1. Save to *mySewnet*<sup>TM</sup>
2. Save To a USB Device
3. Selection Area
4. File Name
5. Save Current State
6. OK
7. Close
8. Create New Folder
9. Toggle Between List and Thumbnail View

## Sew Your Sequence

To sew your stitch sequence, load it to Sewing Mode by touching OK in Sequence Creator.

## Adjust the Entire Sequence

To adjust the entire sequence, enter sewing mode by touching OK. Adjustments made in Sewing Mode will affect the entire sequence. Read about [Stitch Edit](#) in the Sewing chapter.

## Using Sequence Creator in Sewing Mode

In Sewing Mode it is possible to start sewing anywhere in the sequence. Use the arrows to step through the

sequence. In Sewing Mode you can edit your entire sequence.

If you want to edit each stitch in the sequence loaded to Sewing Mode touch the sequence and the Edit Sequence will be highlighted. Touch to enter Sequence Creator again. Make your adjustments and touch OK to load it to Sewing Mode. Touch cancel to undo.

*Note: Touch and hold in the stitch field area to open the Smart Toolbox to access Edit in Sequence Creator.*

# Pop-up Messages in Sequence Creator

## Stitch Cannot be Added in Sequence

Some stitches are not possible to insert in a stitch sequence, for example buttonholes and special stitch menus such as 4-Way stitches.



## Maximum Number of Stitches Has Been Reached

The stitch you are trying to add will make the stitch sequence too long. Your stitch sequence can be up to approximately 500 mm (20") long and contain up to 199 stitches and commands. If the stitch sequence exceeds the maximum length this pop-up message will appear.

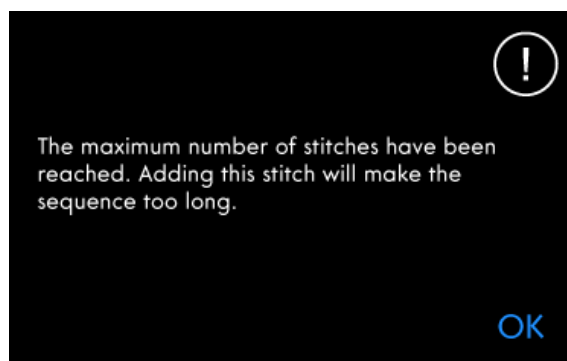

## 7 **Stitch Creator™** Feature

### **Stitch Creator™** Feature – Introduction

In the **Stitch Creator™** feature, you can create completely new stitches and adjust every single stitch point. You can create a stitch all on your own or alter already built-in stitches or letters.

The width of the stitch field is 9mm and maximum stitch length is 5mm. The grid and the vertical center line will help you to create your stitch. Your stitch can be saved to the *mySewnet™* cloud folder or to a USB device.

To open **Stitch Creator™** feature, just touch the **Stitch Creator™** feature icon.

# Stitch Creator™ Feature – Overview

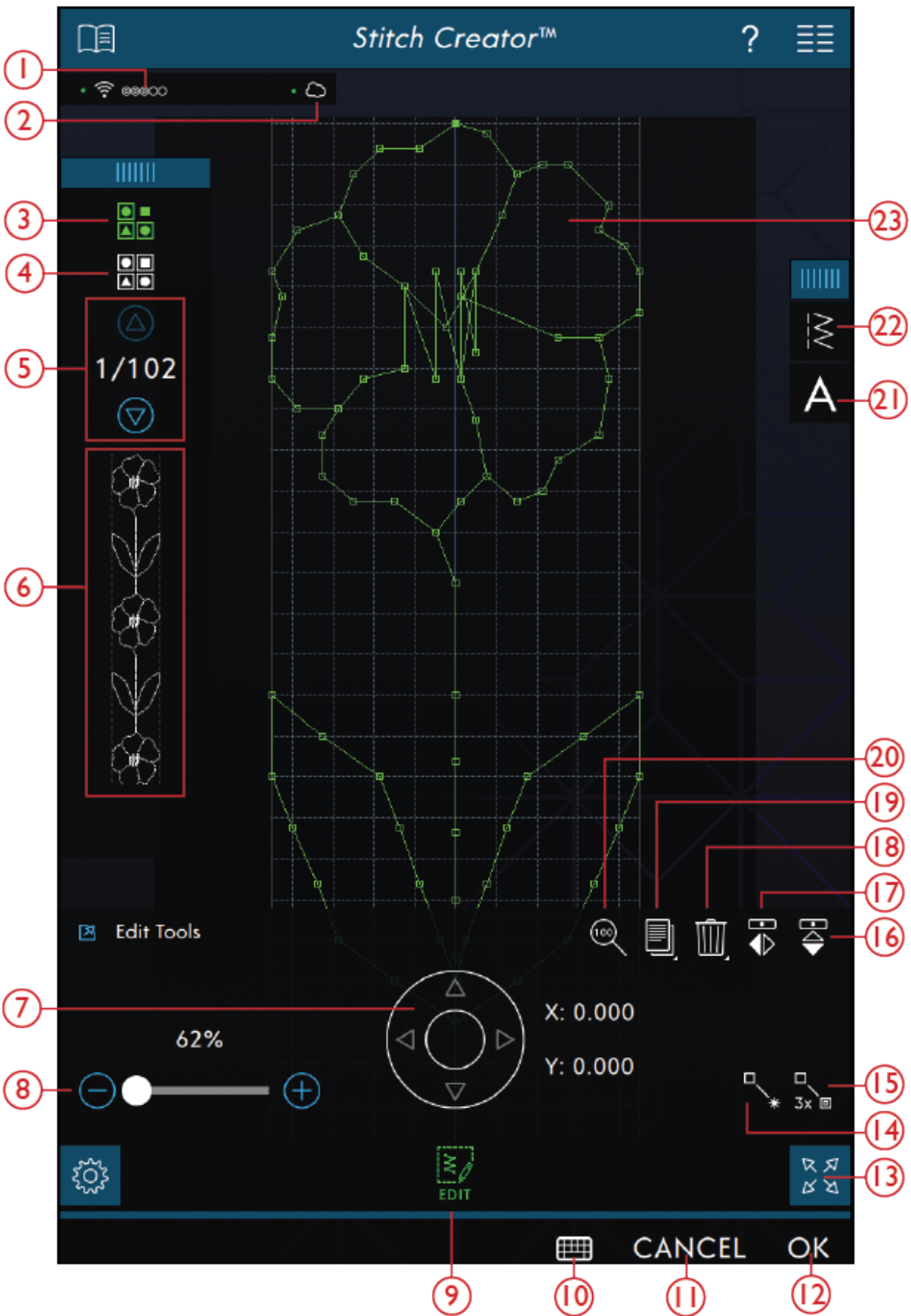

1. WiFi Connection
2. mySewnet™ cloud
3. Multi-Select
4. Select All
5. Arrows (shows current stitch)
6. Preview

7. Move Wheel with Stitch Position (X=stitch needle position, Y=feeding length)
8. Zoom Slider
9. Edit
10. Keyboard
11. Cancel
12. OK
13. Full Screen View
14. New Stitch Point
15. Triple Stitch

16. True Size
17. Duplicate
18. Delete
19. Mirroring Side to Side
20. Mirroring End to End
21. Load Font
22. Load Stitch
23. Stitch Field

## Getting Started with **Stitch Creator™**

### Definition of a Stitch Point

A stitch point is the point where the needle goes through the fabric. Stitches are connected by stitch points.

Each stitch point is indicated by a dot. A selected stitch point is indicated by an outlined square (A). A marked stitch point is indicated by a filled square (B).



### Select Stitches/Stitch Points

To select a stitch point, just touch it on screen. If selecting more than one stitch point, the stitches in between will automatically be selected as well.

To mark the previous or next stitch point in your stitch, touch the Multi Select icon and use the arrows. The current stitch position is shown between the arrows. The first number is the marked stitch point. The second number is the total number of stitch points.

To select all stitch points at the same time, touch the Select All icon.

If the icon is green, it means that it is activated, and if it is white it is deactivated.

### Multi-Select

To select the stitch points next to the marked stitch point, touch Multi-Select and then touch the arrows to select the next stitch point.

Use the Up arrow to select stitch points before the marked stitch point and the Down arrow to select the stitch points after the marked stitch point.

*Note: If selecting stitch points using the Up arrow, you can deselect them by touching the Down arrow.*

If the icon is green, it means that it is activated, and if it is white it is deactivated.



Multi-Select

## Select All

To select all stitch points at the same time, touch the Select All icon. To deselect all, touch the icon again.

If the icon is green, it means that it is activated, and if it is white it is deactivated.



Select All

## Preview

When making a stitch in **Stitch Creator™** a preview of your created stitch will appear. This will help you see what the stitch will look like when having several repeats.



## Stitch Creator™ Edit Tools

### Zoom

When using the Zoom Slider, the focus will be on the marked stitch point.

The distance between the grid lines at 100% zoom, equals 1mm on the fabric. If you zoom in on the stitch field, the distance between the grid lines will change. If zooming out, only the edge lines of the stitch field will be visible.

You can also zoom in/out by pinching and stretching.

### Move

To move your stitch or stitch point, you can select stitch points directly on the Multi-Touch Screen using your fingers or by touching the arrows in the wheel.

The number above the wheel (X) shows the actual needle position from the center line for the marked stitch point.

The number above the wheel (Y) shows the actual feeding length from the previous stitch point.

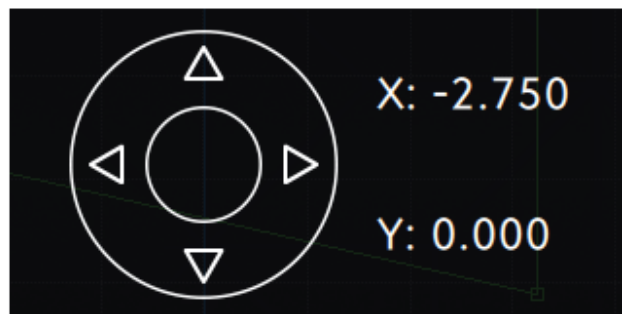

## Add a Stitch or Stitch Point

You can also add an existing stitch from the stitch selection shortcut in the menu bar or the Selection Menu.

Touch the icon to insert one single stitch point. The two stitch points will create a new stitch.

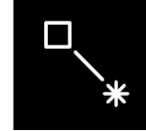

*New Stitch*

## Duplicate Selected Stitch Point

If you want to duplicate a stitch point, select the stitch point and use Duplicate to create a copy.

If several stitch points are selected, all stitch points will be duplicated and inserted after the marked stitch point.

Touch & hold on the Duplicate icon to get a pop-up where you can enter the exact number of duplicates you want to insert.



*Duplicate*

## Triple Stitch

Touch the Triple Stitch icon and the selected stitch(es) will be tripled.

*Note: Only enabled if more than one stitch point is selected.*

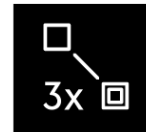

*Triple Stitch*

## Mirroring

The selected stitch point(s) will be mirrored horizontally and/or vertically.

*Note: Only enabled if more than one stitch point is selected.*

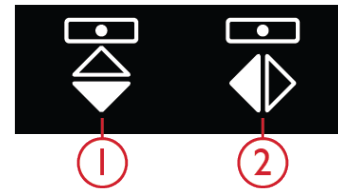

1. Mirror Side to Side
2. Mirror End to End

## Delete Selected Stitch Point

If you want to delete a single stitch point, select the stitch point and touch the Delete icon. If more than one stitch point is selected, they will all be deleted when touching the delete icon.

Touch & hold on the Delete icon to delete all stitch points in the stitch field.



*Delete*

## Edit a stitch made in **Stitch Creator™**

If you are in sewing mode and want to edit a stitch created in **Stitch Creator™**, touch and hold on the work area and the Smart Toolbox will appear. Select Edit in **Stitch Creator™** and the stitch will open in **Stitch Creator™**.

## Saving a Stitch

To save a stitch made in **Stitch Creator**, touch the Save button outside the screen. A pop-up will appear so that you can name the stitch and decide where to save it. Your stitch can be saved to the *mySewnet™* cloud folder or to a USB device. See [Save Stitch](#) for more information. Touch OK to confirm.

## Using Created Stitches in Sequence Creator

A stitch created in **Stitch Creator™** feature can be used as part of a sequence. In **Sequence Creator**, open Selection Menu and locate your saved stitch. The stitch will be inserted at the cursor position in the sequence.

## Pop-up Messages in **Stitch Creator™** Feature

### Not an Editable Stitch

Some stitches are not available to edit in **Stitch Creator™** feature. Buttonholes, stitches wider than 9mm and four direction stitches cannot be opened in **Stitch Creator™** feature.

### Sequence Out of Range

Your stitch sequence can be up to approximately 500mm (20") long. If the sequence exceeds the maximum length this pop-up will let you know that stitch or stitch point you are trying to add will make the sequence too long.

## Load and Sew a Stitch

To sew the created stitch touch OK in the lower right corner of the screen. Your stitch will be loaded to Sewing Mode and is ready to be sewn.

If you touch Cancel in **Stitch Creator™**, you will return to sewing mode without the stitch you have created in **Stitch Creator™**.

If you select another stitch in Sewing Mode and then re-open **Stitch Creator™** feature, your created stitch will not remain in **Stitch Creator™**.

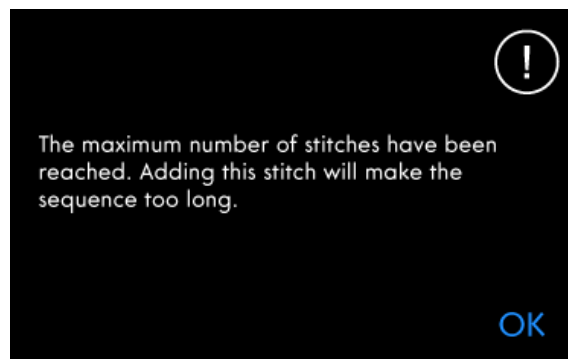
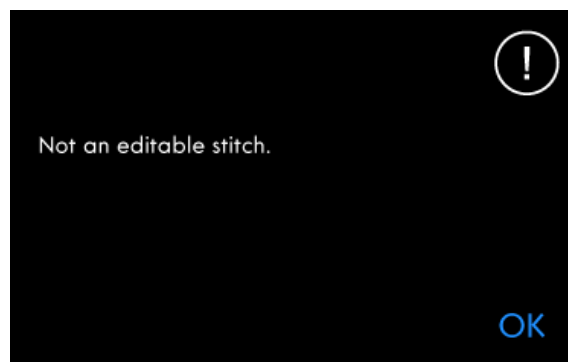

# 8 Help Center

## Help Center – Introduction

In the Help Center you will find information on how to use your performance icon™ machine and learn more about its features.

## Help Center – Overview

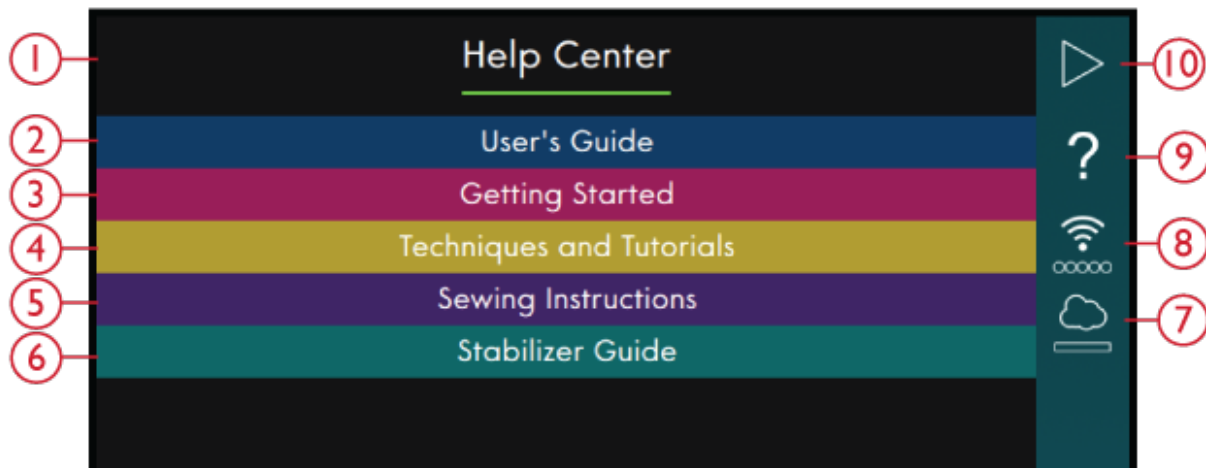

- 1. Help Center Window
- 2. [User's Guide](#)
- 3. [Getting Started](#)
- 4. [Techniques and Tutorials](#)
- 5. [Sewing Instructions](#)
- 6. [Stabilizer Guide](#)
- 7. [mySewnet™](#)
- 8. [WiFi Settings](#)
- 9. [Quick Help](#)
- 10. Return to Previous Window

# User's Guide

Touch User's Guide to open the built-in User's Guide. Here you will find information about how to operate your performance icon™ machine and what the different features of the machine are.

You can see the User's Guide by Index or by looking in the Category. The category option shows the help topics divided into categories following the structure of the User's Guide. The index option shows topics in an alphabetical order.

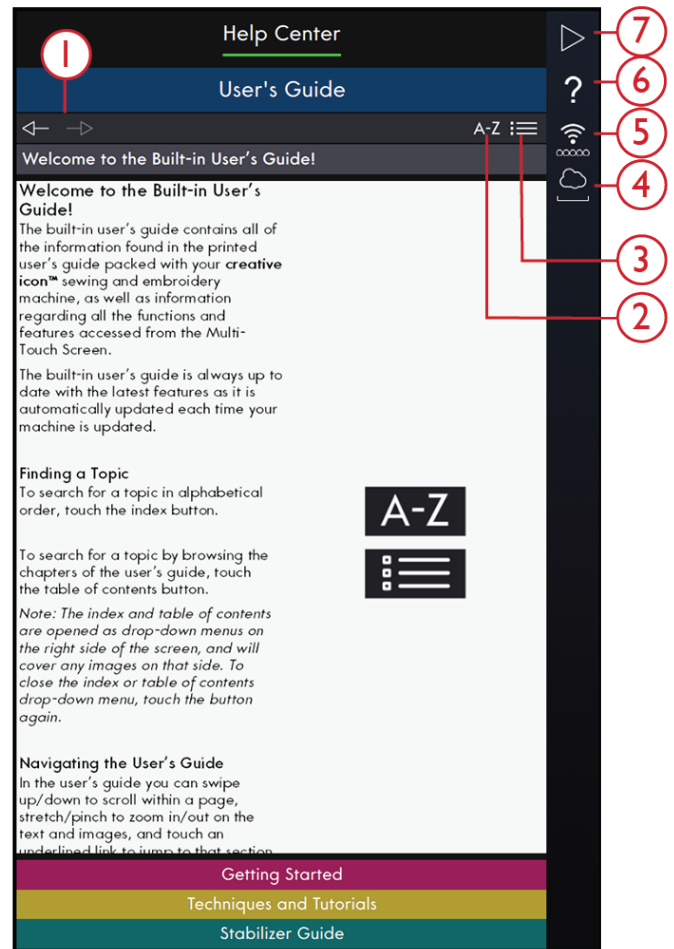

1. Navigation Arrows
2. Index
3. Category
4. mySewnet™
5. WiFi Settings
6. Quick Help
7. Return to Previous Window

## Getting Started

In this section you will find help that has to do with the basics of the machine such as threading the machine, how to engage and disengage the IDT™ and more.

Some of the guides will show animations.

Select which topic you are interested in by touching it. A Project Viewer will open with Step-by-Step instructions and animations.

- Threading the Upper Thread
- Automatic Needle Threader
- Engage/Disengage the IDT™ System
- Bobbin Winding
- Bobbin Winding Through Needle
- Inserting the Bobbin

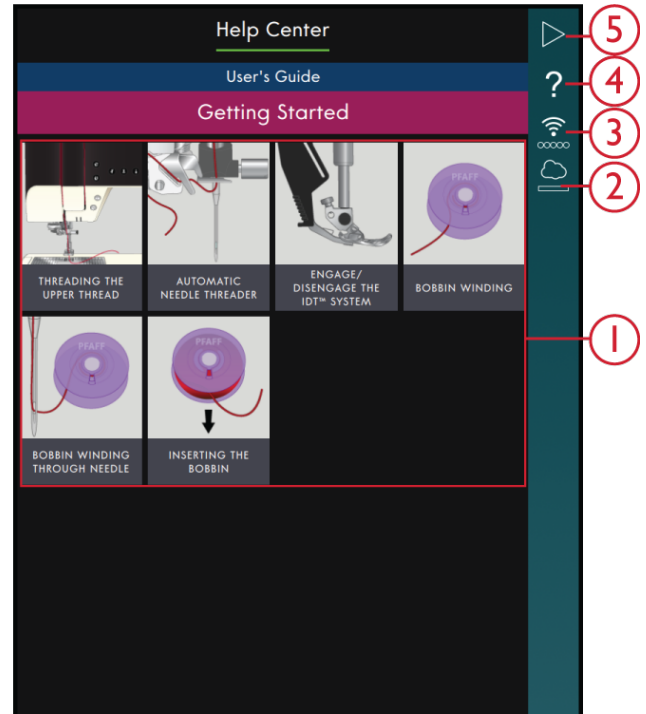

1. Quick Start Guides
2. *mySewnet*™
3. WiFi Settings
4. Quick Help
5. Return to Previous Window

# Techniques and Tutorials

Touch to open Techniques and Tutorials. There are different categories to choose from such as Garment-, Sewing- and Quilt-techniques. Select a technique category and then select a technique sub-category to see the projects available. Touch on a project to open it.

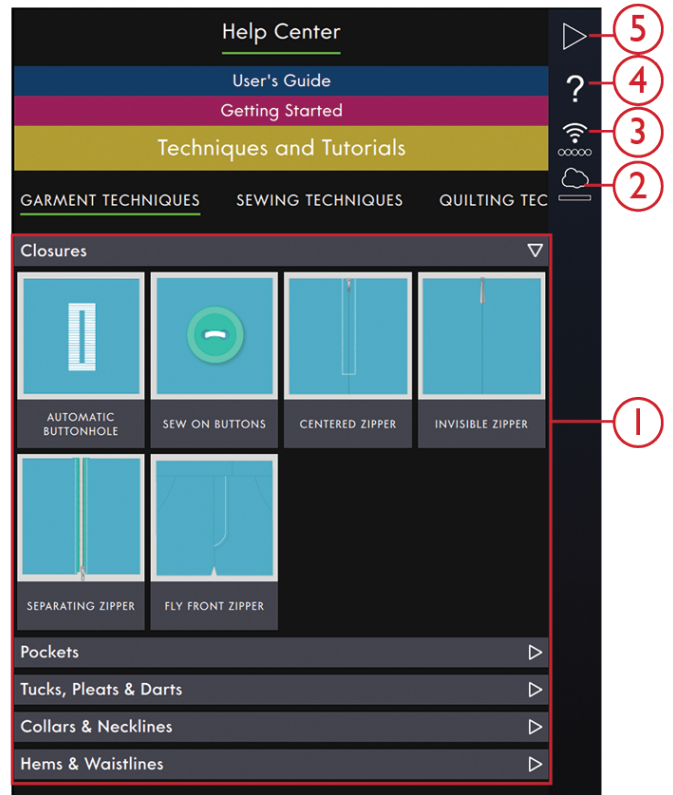

1. Tutorials
2. *mySewnet*<sup>TM</sup>
3. WiFi Settings
4. Quick Help
5. Return to Previous Window

## Garment Techniques

In this section you will find tutorials about how to sew different sewing techniques for garments such as collars, zippers, pockets etc.

In each project you will find Step-by-Step instructions with images and/or animations. The stitches needed for the chosen technique is filtered out for you and are available in the content tab. However, you may need to adjust the setting of the stitches (length, width etc) depending on what fabric type you are using for your project. The stitches are always set for sewing in woven medium fabric.

## Sewing Techniques

In this section you will find tutorials about how to sew different kinds of sewing techniques such as the exclusive sewing techniques etc.

In each project you will find an instruction with images and/or animations. The stitches needed for the chosen technique is filtered out for you. However, you may need to adjust the setting of the stitches (length, width etc) depending on what fabric type you are using for your project. When selecting a stitch from the project viewer, all settings needed for the specific technique is set for you.

## Quilting Techniques

In this section you will find tutorials about how to sew different kinds of quilt techniques such as piecing, binding etc.

In each project you will find Step-by-Step instructions with images and/or animations. The stitches needed for the chosen technique is filtered out for you. However, you may need to adjust the setting of the stitches (length, width etc) depending on what fabric type you are using for your project.

## Stabilizer Guide

Touch to open the Stabilizer Guide. Select a stabilizer group to view different stabilizers within the group. Touch a stabilizer to see more information about when to use it. The information about the stabilizer is shown in a viewer. Close the viewer to select another stabilizer in the group.

- **Specialty:** In this category you will find stabilizers for special uses.
- **Tear-a-away:** Tear-a-way stabilizers are temporary stabilizers. They are easy to remove after sewing.
- **Batting:** Use batting between your top fabric and backing to add body to your project.

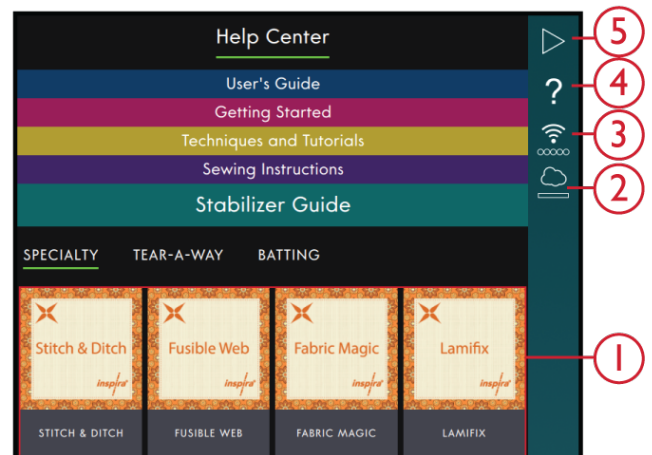

1. Stabilizer Guides
2. *mySewnet*<sup>TM</sup>
3. WiFi Settings
4. Quick Help
5. Return to Previous Window

# Projects

When loading a project from the Help Center it will be shown in the Project Viewer which is always accessible on the screen. When the Project Viewer is minimized, touch the Project Viewer icon to expand.



1. Project Viewer Icon in the Menu Panel

## Project Viewer

When you have selected a project, a Project Viewer will be opened. The Viewer can be minimized or closed by touching the Close or Minimize icon. It can also be moved around on your screen so that you will be able to reach icons that may be hidden when following the instructions.

You can decrease or increase the text in the Viewer by touching one of the A icons.

There are two tabs that you can toggle between, Instruction and Content. The Instruction tab contains all instructions, images and animations that you need to see to be able to do the project.

In the content tab you will find the stitches you need for the specific project.

Use the arrows or swipe vertically to go to the next step. The step with a green frame is the active step.

All images can be enlarged by touching on them. This can be very helpful when looking at the list of materials.

When you touch on the Play icon, a video player will open showing you how to make that particular part.

Some projects contain a Stitch icon, and when you touch them, you will load the stitch that is needed for that step.

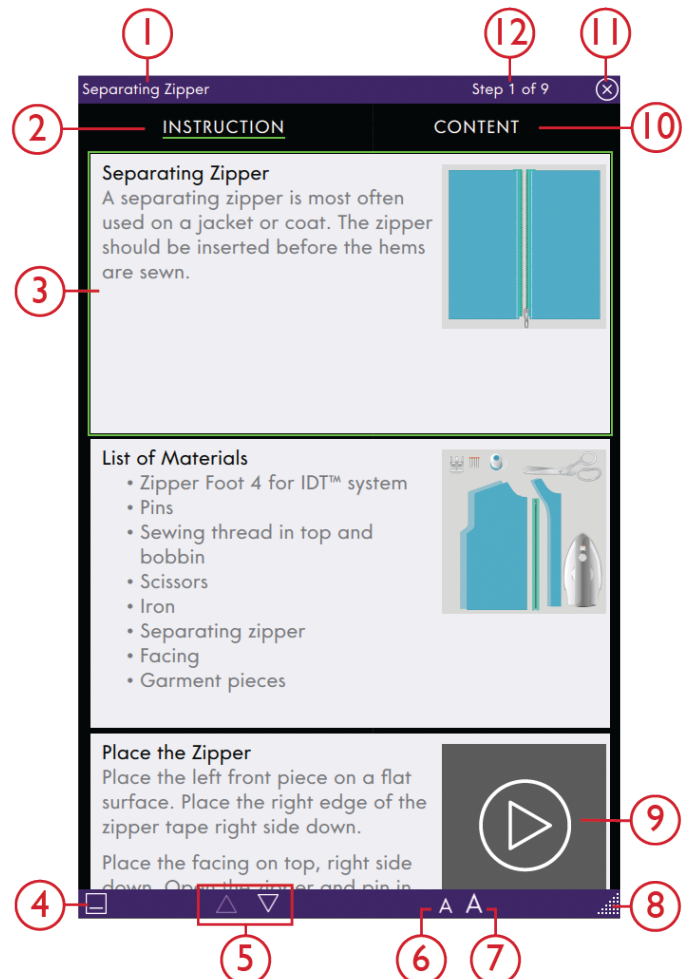

- |                                   |                       |
|-----------------------------------|-----------------------|
| 1. Project Viewer                 | 7. Increase Text Size |
| 2. Instruction                    | 8. Expand Window      |
| 3. Active Step                    | 9. Play               |
| 4. Minimize                       | 10. Content           |
| 5. Step Between The Project Steps | 11. Close             |
| 6. Decrease Text Size             | 12. Current Step      |

## Video Player

Touch the Play icon to view the animation. In the video player that opens you can Play/Pause, Rewind, Fast Forward, set the animation on Repeat and turn Full Screen View On/Off. You can also drag the Slider to move forwards or backwards in the animation.

Touch & hold on Rewind to start the animation from the beginning.

Touch the Chapter /Section icon to toggle between seeing the entire video or current chapter.

Close the animation by touching the X. You can also touch outside the video player window to close.



1. Chapter/Section Icon
2. Slider
3. Rewind
4. Play/Pause
5. Fast Forward
6. Repeat
7. Full Screen View
8. Close

# 9 File Manager

## File Manager – Introduction

Touch Main Menu and select File Manager tab to open the File Manager.

File Manager is used to open font files and stitch files. Store your saved files in the *mySewnet*<sup>™</sup> cloud folder or to a USB device connected to your performance icon<sup>™</sup> machine.

# File Manager – Overview

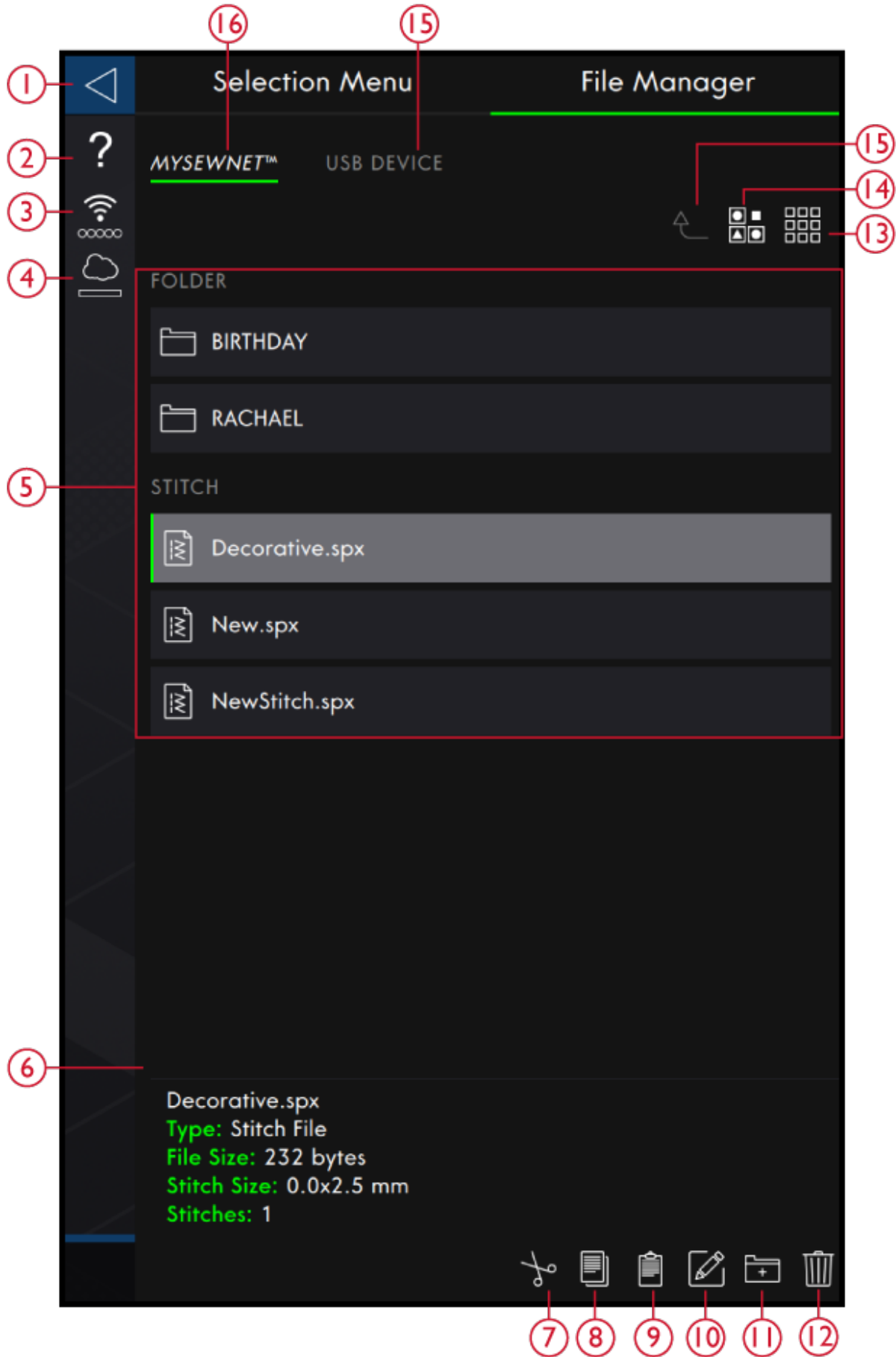

1. Return To Previous Window

2. Quick Help
3. WiFi Signal Strength
4. mySewnet™ cloud folder
5. Selection Area
6. File Information
7. Cut
8. Copy
9. Paste
10. Rename File or Folder
11. Create New Folder
12. Delete
13. List/Thumbnail View
14. Multi-Select
15. Move Up One Folder
16. USB Device
17. mySewnet™ cloud folder

## File Formats

Your performance icon™ machine can load the following file formats:

- .SPX (stitch file)
- .JOS (project files)

*Note: If the file type or file version is not supported by your machine, or the file is damaged, it is shown in the selection area as an unrecognized file.*

## Browse File Manager

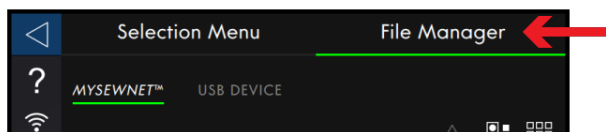

Store your fonts and stitches in the *mySewnet*™ cloud folder or to a USB device connected to the USB ports.

## Multi-Select

If you want to select several stitches or fonts at one time, touch the Multi-Select icon. While Multi-Select is activated, touch the files you want to use. Copy and Paste the selected files e.g. to another folder in File Manager.

*Note: If trying to load a combination of files/folders that is not possible to load to the same destination a pop-up message will be shown.*

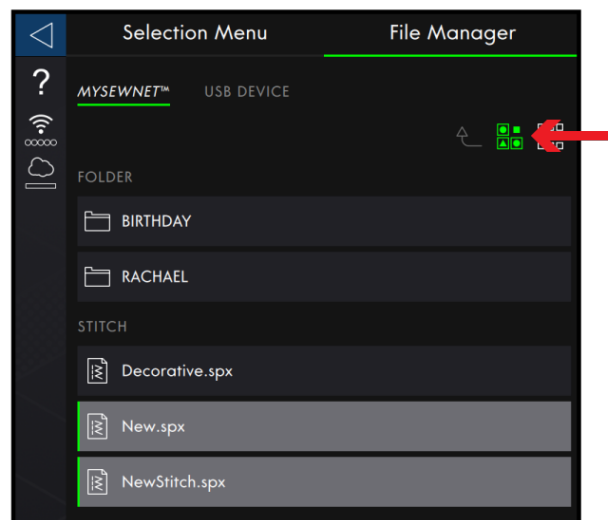

## *mySewnet*™ Cloud Folder

Save stitches and fonts to the *mySewnet*™ cloud folder on the machine. If you are signed in to a *mySewnet*™ account and connected to *mySewnet*™ your saved files will be synchronized automatically with the *mySewnet*™ cloud. Read about *mySewnet*™ cloud.

## USB Device

The USB Device icon is only active when a USB device is connected to the machine. Touch the USB Device icon to display all of the connected devices. Touch a USB device to explore it.

The USB Device icon is only available when a USB device is connected to your machine.

To display the content, touch the *mySewnet*™ cloud folder or USB Device. Swipe with your finger upwards and downwards to scroll and view the content. Font files are displayed as thumbnail images or with an icon depending on if you have List View or Thumbnail View selected.

## Open a File or Folder

Touch a file to read information about the file in the file information area. Touch & hold the file to load it.

If you load a stitch font file, it will be loaded into Sequence Creator.

Touch & hold on a folder to open it. The content of the folder will be shown in the selection area. The path of an open folder is written in the current folder area.

MYSEWNET™

USB DEVICE



## List/Thumbnail View

Touch the List/Thumbnail View icon to toggle between showing the files in a list or as thumbnail icons. In list view each file is shown with the file name and file type. In thumbnail view each file is shown with file name and a thumbnail image of the file.

In list view all files are sorted into categories with separate headings; Folder, Stitch and Other. This makes it easier to find a specific file if you have many different file types in the same folder.

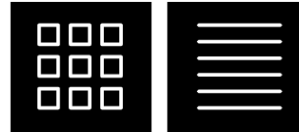

*List/Thumbnail View*

## Move up One Folder Level

Use the move up one folder level icon to step up through the levels of folders. You can step up all the way to the first level. In the selection area you will see the files and folders for each level as you step up. Touch & hold on a folder to open it.



*Move up One Folder Level*

## Organize

Below are instructions on how to organize your files in File Manager.

### Create New Folder

Touch the create new folder icon to create a new folder in the current position. A pop-up message opens where you can enter a name for your folder.



*Create New Folder*

### Rename a File or Folder

To change the name of a file or folder, touch to select it and then touch the rename file or folder icon. A pop-up message opens where you can enter the new name for a file or folder.



*Rename*

### Move a File or Folder

Use cut and paste to move file(s) or folder(s) to another location.

Select the file(s) or folder(s) and then touch the cut icon. Open the folder where you want to place the selection. Touch the paste icon. The file(s) or folder(s) is removed from its original location and now stored in the new folder.

*Note: Activate Multi-Select to be able to select and move more than one file and/or folder the same time.*



*Cut*



*Paste*

## Copy a File or Folder

Use copy and paste to copy file(s) or folder(s) to another location.

Select the file(s) or folder(s), then touch the copy icon. Open the folder where you want to place the selection. Touch the Paste icon. The file(s) or folder(s) is now stored in the new folder and the original file(s) or folder(s) still exists in the previous folder.

*Note: Activate Multi – Select to be able to select and move more than one file and/or folder at the same time.*



*Copy*



*Paste*



*Delete*

## Delete a File or Folder

To delete a file or folder, select it and touch the delete icon. A pop-up message will appear so that you can confirm the deletion. If a folder is deleted, all files within the folder are deleted as well.

To delete all files and folders shown in the active folder, touch & hold the delete icon for a few seconds. A pop-up message will appear so that you can confirm the deletion of all content.

## Pop-up Messages in File Manager

### Delete File or Folder

When deleting a file or folder, you will need to confirm the deletion in the pop-up message that appears on screen. This will prevent you from deleting anything by mistake.

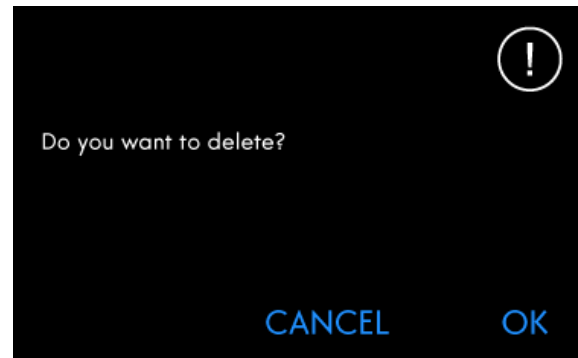

### Folder Already Exists

You cannot create a new folder with the same name as another folder on the same level. Create your folder on a different level or enter a different name for the folder.



### Not Enough Available Memory

When only a small amount of space is left, your machine will alert you one time. If you continue to fill the space, it will not remind you again, until the space is completely full. Move your files to a USB device by using the cut and paste functions to free up space.



### The Combination of Selected File Types Cannot be Loaded

Some file combinations can not be loaded to the same destination using Multi-Select.

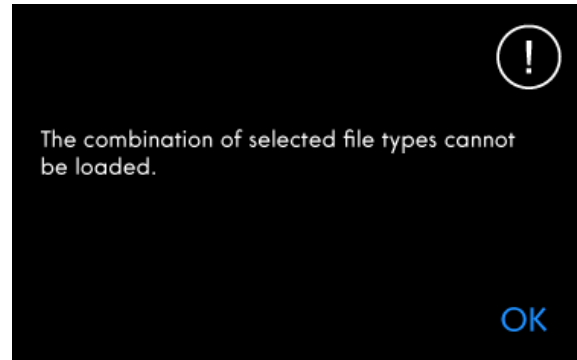

# 10 Maintenance

## Cleaning the Machine Exterior

To keep your sewing machine operating well, clean it often. No lubrication (oiling) is needed.

Wipe the exterior surface of your machine with a soft cloth to remove any dust or lint built up.

Wipe the screen with a clean, soft and slightly damp microfiber cloth.

## Removing the Needle Plate and Cleaning the Bobbin Area

 *Turn off the machine.*

Remove the presser foot. Open the bobbin cover by pushing the release button (A) to the right. Remove the cover. Place the supplied screwdriver under the needle plate as shown and gently turn the screwdriver to pop off the needle plate. Clean the feed teeth with the brush that is included with the accessories.

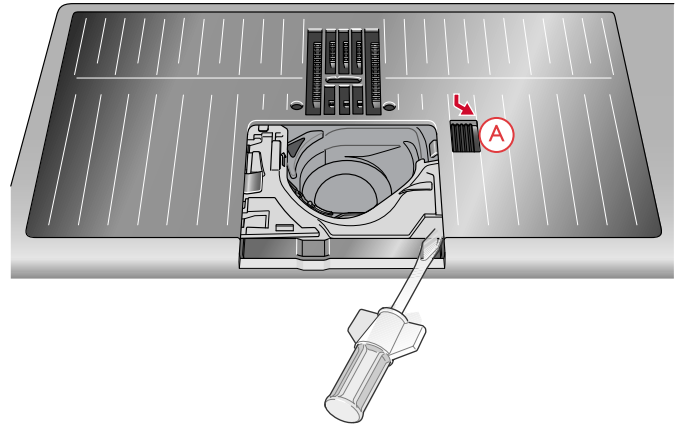

## Cleaning Under the Bobbin Area

Clean the area under the bobbin case after sewing several projects or any time you notice an accumulation of lint in the bobbin case area.

Remove the bobbin case holder (A) covering the front part of the bobbin case by lifting it up. Remove the bobbin case (B) by lifting it up. Clean with the brush.

 *Use caution when cleaning around the automatic thread cutter knife (C).*

Put the bobbin case and the bobbin case holder back in place.

*Note: Do not blow air into the bobbin case area. The dust and lint will be blown into your machine.*

*Note: Regularly clean the lint and threads from the bobbin area. Check the area when changing the needle plate.*

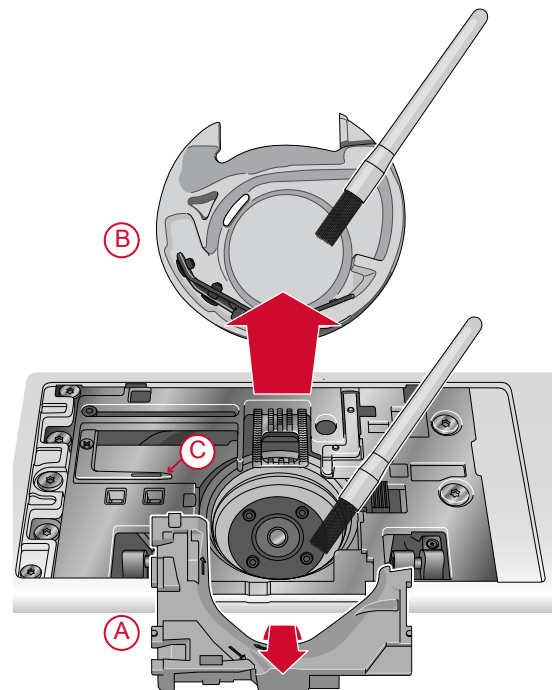

## Replacing the Needle Plate

Position the needle plate so that it fits into the notch at the back (D). Press the needle plate down until it clicks into place. Replace the bobbin cover.

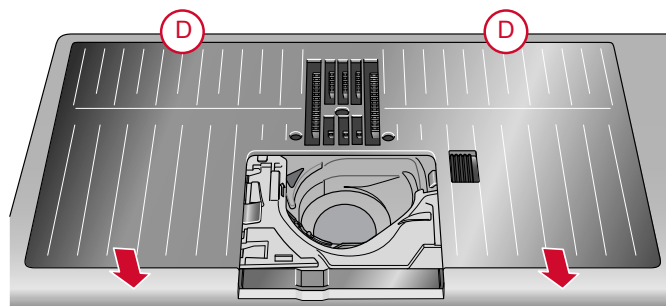

## Troubleshooting

In this troubleshooting guide you will find solutions to the problems you may have with your machine. For

further information please contact your local authorized PFAFF® retailer who will be happy to help you.

### General Problems

Bobbin alarm does not work	Clean lint from bobbin area and use only the original PFAFF® bobbins designed especially for this model.
Thread cutter does not cut the thread	Remove needle plate and clean lint from bobbin area. Enable automatic thread cutter in the settings menu.
Fabric does not feed	Make sure the machine is not set for free motion sewing. Make sure the feed teeth are not set to down in the settings menu.
Wrong stitch, irregular or narrow stitch	Deactivate twin needle or stitch width safety in the settings menu.
The needle breaks	Insert needle correctly as described, see <a href="#">Changing the Needle, page 29</a> . Use a needle suitable for selected fabric. See <a href="#">Selecting Correct Thread/Needle Combination, page 32</a> .
The machine will not sew	Check that all plugs are securely inserted into the machine and the wall socket.
Poor sewing result	Use only accessories designed for your performance icon™ machine. Follow the on-screen recommendations.
The sewing machine screen and/or function buttons do not respond to touch	The sockets and function buttons on the machine can be sensitive to static electricity. If the screen does not respond to touch, turn the machine OFF and then ON again. If the problem persists, contact your authorized PFAFF® retailer.
When sewing in heavy and/or dense fabrics the machine emits a distinct sound different from the sound normally generated when sewing.	The sound is not an indication of malfunction. The machine is equipped with a pulsating needle piercing feature that helps the needle to penetrate heavy and/or dense fabrics. The sound is caused when the presser foot and fabric lift with the needle. Increase the presser foot pressure to prevent the foot from lifting. If the sound does not seem to be related to the pulsating needle piercing feature, contact your authorized PFAFF® retailer for service.

## The Automatic Needle Threader Does Not Work Properly

The needle eye is too small for the thread	Use a larger needle size or lighter weight thread. See <a href="#">Selecting Correct Thread/Needle Combination, page 32</a>
Are you using a specialty thread such as an “invisible” or other stretchy thread, metallic or flat metallic thread or heavy weight thread?	Specialty threads may not be caught correctly by the hook on the automatic needle threader. If this happens, the needle will not be threaded. Try using the automatic needle threader again or thread the needle manually.
Pop-up message: The automatic needle threader is not in its home position. Touch OK to calibrate.	The needle threader has shifted from its home position, possibly due to something snagging on it during sewing. Touch OK to calibrate the needle threader and continue sewing.
Pop-up message: The calibration of the automatic needle threader has failed. Touch OK to calibrate again. If the automatic needle threader still does not calibrate correctly, please contact your local authorized service center.	Shown if the machine fails to calibrate the needle threader when turning on the machine. Remove anything that may be blocking the needle threader and touch OK.
Pop-up message: The automatic needle threader seems to be blocked and cannot return to its home position. Touch OK to move the automatic needle threader to position for manual cleaning.	If using thread that is too thick for the needle, the automatic needle threader may not be able to pull the thread through the needle eye. Touch OK to go to manual cleaning. A new pop-up message with further instructions will appear.  If you cannot identify the problem or are unable to remove the thread, touch cancel.
Pop-up message: Gently remove any thread that is stuck in the automatic needle threader or needle eye. Touch OK to return the automatic needle threader to its home position.	If using thread that is too thick for the needle, the automatic needle threader may not be able to pull the thread through the needle eye. Remove the thread carefully so as not to damage the small hook that runs through the needle eye. Once the thread is removed, touch OK.
Pop-up message: The automatic needle threader is not in its home position. Further sewing is disabled to prevent damage to the machine. After closing this pop-up, touch the automatic needle threader button on your machine to try threading again or contact your local authorized service center.	Contact your authorized PFAFF® retailer for service.
Pop-up message: The automatic needle threader cannot return to its home position. Further sewing is disabled to prevent damage to the machine. Please contact your local authorized service center.	Contact your authorized PFAFF® retailer for service.

## The Machine Skips Stitches

Did you insert the needle properly?	Insert needle correctly as described, see <a href="#">Changing the Needle, page 29</a> .
Did you insert a wrong needle?	Use needle system 130/705 H.  Use a needle suitable for selected fabric and thread. See <a href="#">Selecting Correct Thread/Needle Combination, page 32</a> .
Is the needle bent or blunt?	Insert a new needle.
Did you thread the machine properly?	Remove the thread completely and rethread the machine, see <a href="#">Threading the Upper Thread, page 30</a> .
Is the correct presser foot used?	Attach correct presser foot.

Is the needle too small for the thread?	Change the needle.
Is the fabric moving up and down with the needle when free motion sewing?	If using the 6A Embroidery/Sensormatic Free Motion Foot, decrease the pivot height in settings menu in small increments until the problem is solved.

## Needle Thread Breaks

Did you insert the needle properly?	Insert needle correctly, see <a href="#">Changing the Needle, page 29</a> .
Did you insert a wrong needle?	Use needle system 130/705 H. Use a needle suitable for selected fabric and thread. See <a href="#">Selecting Correct Thread/Needle Combination, page 32</a> .
Is the needle bent or blunt?	Insert a new needle.
Did you thread the machine properly?	Remove the thread completely and rethread the machine, see <a href="#">Threading the Upper Thread, page 30</a> .
Does the thread slide down and get caught under the thread spool?	Place the large spool holder with the flat side up under the spool on the spool pin, or for larger spools use a thread net over the spool. See <a href="#">Threading Tips and Hints, page 34</a> .
Is the needle too small for the thread?	Change the needle to the proper size for the thread.
Are you using poor thread with slubs or thread which has become dry?	Change to a new high quality thread purchased from an authorized PFAFF® retailer.
If using a spool cap on top of the spool, is it too small so the thread snags at the top of the spool?	Attach a spool cap slightly larger than the actual thread spool.
Is the best spool pin position used?	Try a different spool pin position (vertical or horizontal).
Is the needle plate hole damaged?	Change the needle plate.
Is the thread tension too high for selected thread?	Lower the thread tension in small increments until problem is solved.

## Bobbin Thread Breaks

Is the correct bobbin used?	Use only bobbins especially designed for the performance icon™ machine.
Did you insert the bobbin properly?	Check the bobbin thread.
Is the needle plate hole damaged?	Change the needle plate.
Is the bobbin area full of lint?	Clean lint from bobbin area and use only the original bobbins approved for this model.
Is the bobbin wound correctly?	Wind a new bobbin.

## The Seam has Uneven Stitches

Is the thread tension correct?	Check needle thread tension. Remove the thread completely and rethread the machine, see <a href="#">Threading the Upper Thread, page 30</a> .
Is the thread you are using thick or slubbed?	Change the thread.

Is the bobbin thread evenly wound?	Check bobbin winding.
Is a correct needle used?	Insert a proper needle correctly as described, see <a href="#">Changing the Needle, page 29</a> . Use a needle suitable for selected fabric. See <a href="#">Selecting Correct Thread/Needle Combination, page 32</a> .

## The Machine Does Not Feed or Feeds Irregularly

Did you thread the machine properly?	Remove the thread completely and rethread the machine, see <a href="#">Threading the Upper Thread, page 30</a> .
Has sewing lint collected between the feed teeth?	Remove the needle plate and clean the feed teeth with the brush.
Is the free motion setting on?	Turn off free motion setting in sewing mode.
Are the feed teeth set to down?	Make sure the feed teeth are not set to down in the settings menu.
Is the correct presser foot used?	Attach correct presser foot.

## Service

### Have your sewing machine serviced regularly by your local authorized retailer!

If you have followed this troubleshooting information and still have problems, contact your retailer. It may be helpful to bring the fabric, thread and stabilizer you are using with you. If you have a stitch out that shows the problem, please bring that as well. A sewing sample will often give better information than words and help your technician diagnose the problem.

### Non-Original Parts and Accessories

The warranty does not cover any defect or damage caused by use of non-original accessories or parts.

## Technical specification

### performance icon™ machine

Rated voltage	100–120V/200–240V, 50–60Hz
Nominal consumption	<100W
Light	LED lamps
Sewing speed	1050 stitches/minute maximum
Foot control model	FR5
Safety class	II
<b>WiFi module:</b>	
Frequency	2.4GHz band 802.11 b/g/n
Transmitting power	+17dBm
Receiver sensitivity	-97dBm

Net weight (kg), machine only	14.5
<b>Machine dimensions:</b>	
Length (mm)	590
Width (mm)	220
Height (mm)	400

- The technical specifications and this user's guide can be changed without prior notice.